

DS-2TD3017T-3/V Thermographic Cube Camera



Hikvision DS-2TD3017T-3/V Thermographic Cube Camera is able to measure object's temperature at a high accuracy in real time. It is applied to fire prevention purpose in electric system, industrial automation and so on. The pre-alarm system helps you discover unexpected events immediately and protects your property.

▪ Key Feature

- 160 × 120 (the resolution of output image is 640 × 480) resolution in thermal channel, high sensitivity sensor
- Point, line and area for temperature measurement
- Temperature range: -20 °C to 150 °C (-4 °F to 302 °F), 0 °C to 550 °C (32 °F to 1022 °F); temperature accuracy: Max (± 2 °C, ± 2%)
- Reliable temperature exception alarm function
- 3D DNR, image detail enhancement
- Audio alarm



▪ Specification

Thermal	
Image Sensor	VOx Uncooled Focal Plane Arrays
Resolution	160 × 120
Pixel Interval	17 μm
Response Waveband	8 μm to 14 μm
NETD	≤40 mK (@25°C, F# = 1.1)
Focal Length	3.1 mm
Focus Mode	Athermalized
Field of View	50° × 37.2° (H × V)
I FOV	5.48 mrad
Image Frequency	50 Hz:25 fps
Aperture	F 1.1
Min. Focusing Distance	0.15 m
Optical	
Image Sensor	1/5" Progressive Scan CMOS
Resolution	1600 × 1200
Focal Length	1.29 mm
Min. Illumination	Color: 0.04 Lux @ (2.4, AGC ON)
Field of View	92.6° × 75.8° (H × V)
Aperture	F 2.4
Compression Standard	
Video Compression	H.264 (Baseline/Main/High Profile) / MJPEG/H.265
Video Bit Rate	256 Kbps to 16 Mbps
Smart Function	
Temperature Range	-20 °C to 150 °C (-4 °F to 302 °F), 0°C to 550 °C (32 °F to 1022 °F)
Temperature Accuracy	Max (± 2 °C, ± 2%)
Temperature Measurement Rules	Display Max. and Min. temperature in live view; 3 temperature measurement rule types, 21 rules (10 points, 10 regions, and 1 line).
Image	
Main Stream	Thermal channel: 25 fps (640 × 480) Optical channel: 25 fps (1600 × 1200)
Sub Stream	Thermal channel: 25 fps (640 × 480) Optical channel: 25 fps (1600 × 1200)
Image Enhancement	3D DNR, EIS
Image Setting	Rotate mode, brightness, contrast and AGC adjustable by client software or web browser
Network	
Alarm Trigger	Video tampering alarm, Network disconnected, IP address conflict, Illegal login, HDD full, HDD error
Protocols	IPv4/IPv6, HTTP, HTTPS, 802.1x, Qos, FTP, SMTP, UPnP, SNMP, DNS, DDNS, NTP, RTSP, RTCP, RTP, TCP, UDP, IGMP, ICMP, DHCP, PPPoE, Bonjour
General Function	One-key reset, heartbeat, mirror, password protection, privacy mask, watermark, IP address filter

Interface	
Communication Interface	1, RJ45 Ethernet port 1, RS-485 interface
Alarm	1 input, 1 output
Thermographic Integration	
External Optics Correction	Support Thermal Optical Transmittance and Manual Input External Optics Temperature; Support Calibration Coefficient calculation
Temperature Info. Of Thermographic Rule	Real-time Output; Time Interval: 500 ms
Temperature Info. of Image	Real-time Output; Default is 4 fps, 32 bit × 640 × 512 per frame; 16 bit and 32 bit are selectable
Capture Thermal Graphic	32 bit 160 × 120
Metadata Output	Max. 25 fps (16 bit 160 × 120)
Image Display	
Image Fusion	Fusion view of thermal view and overlaid details of the optical channel
Digital Zoom	2×, 4×
System Function	
Lighting	Yes
General	
Menu language	English
Power Supply	10-30 VDC, Max. 5 W PoE (802.3af, class 2)
Working Temperature and Humidity	-20 °C to 50 °C (-4 °F to 122 °F) 95% or less
Protection level	IP 67
Weight	Approx. 335 g (0.74 lb)
Dimension	56 mm × 38.8 mm × 110 mm (2.20" × 1.53" × 4.33")

▪ Available Model

DS-2TD3017T-3/V

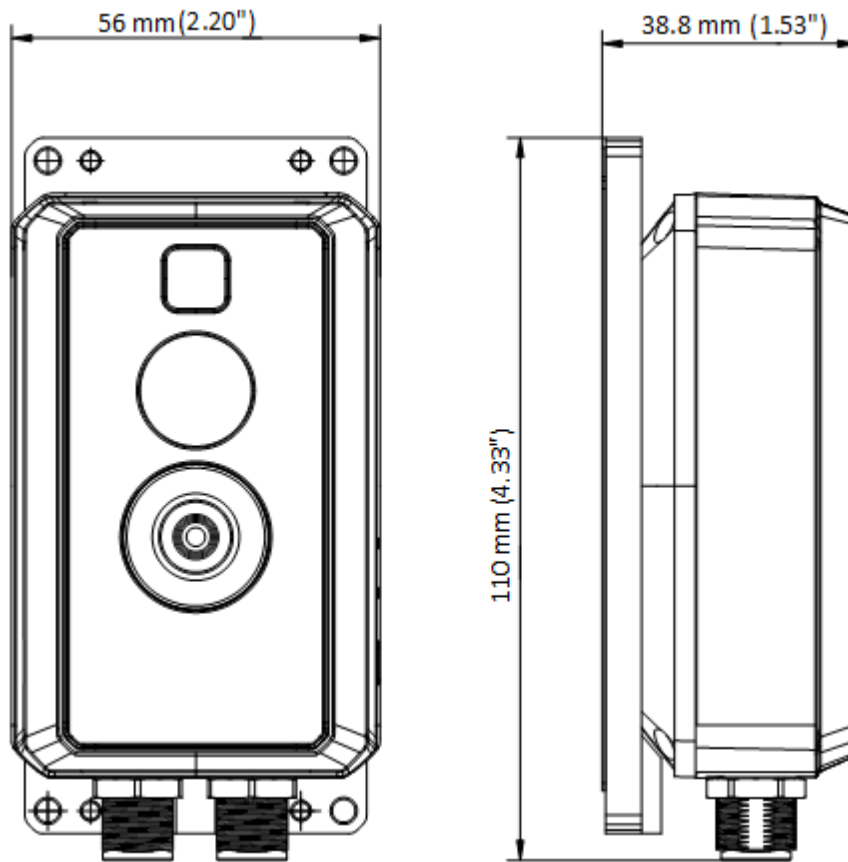
▪ Dimension**▪ Accessory****▪ Optional**

COMPLIANCE NOTICE: The thermal series products might be subject to export controls in various countries or regions, including without limitation, the United States, European Union, United Kingdom and/or other member countries of the Wassenaar Arrangement. Please consult your professional legal or compliance expert or local government authorities for any necessary export license requirements if you intend to transfer, export, re-export the thermal series products between different countries.

Distributed by

**HIKVISION®****Headquarters**

No.555 Qianmo Road, Binjiang District,
Hangzhou 310051, China
T +86-571-8807-5998
overseasbusiness@hikvision.com

Hikvision USA
T +1-909-895-0400
sales.usa@hikvision.com

Hikvision Australia
T +61-2-8599-4233
salesau@hikvision.com

Hikvision India
T +91-22-28469900
sales@pramahikvision.com

Hikvision Canada
T +1-866-200-6690
sales.canada@hikvision.com

Hikvision Thailand
T +662-275-9949
sales.thailand@hikvision.com

Hikvision Europe
T +31-23-5542770
sales.eu@hikvision.com

Hikvision Italy
T +39-0438-6902
info.it@hikvision.com

Hikvision Brazil
T +55 11 3318-0050
Latam.support@hikvision.com

Hikvision Turkey
T +90 (216)521 7070- 7074
sales.tr@hikvision.com

Hikvision Malaysia
T +601-7652-2413
sales.my@hikvision.com

Hikvision UK & Ireland
T +01628-902140
sales.uk@hikvision.com

Hikvision South Africa
Tel: +27 (10) 0351172
sale.africa@hikvision.com

Hikvision France
T +33(0)1-85-330-450
info.fr@hikvision.com

Hikvision Kazakhstan
T +7-727-9730667
nikia.panfilov@hikvision.ru

Hikvision Vietnam
T +84-974270888
sales.vt@hikvision.com

Hikvision UAE
T +971-4-4432090
salesme@hikvision.com

Hikvision Singapore
T +65-6684-4718
sg@hikvision.com

Hikvision Spain
T +34-91-737-16-55
info.es@hikvision.com

Hikvision Tashkent
T +99-87-1238-9438
uzb@hikvision.ru

Hikvision Hong Kong
T +852-2151-1761
info.hk@hikvision.com

Hikvision Russia
T +7-495-669-67-99
saleru@hikvision.com

Hikvision Korea
T +82-(0)31-731-8817
sales.korea@hikvision.com

Hikvision Poland
T +48-22-460-01-50
info.pl@hikvision.com

Hikvision Indonesia
T +62-21-2933759
Sales.Indonesia@hikvision.com

Hikvision Colombia
sales.colombia@hikvision.com