



Explosion-Proof Network Positioning System

Quick Start Guide

Quick Start Guide

COPYRIGHT ©2019 Hangzhou Hikvision Digital Technology Co., Ltd.

ALL RIGHTS RESERVED.

Any and all information, including, among others, wordings, pictures, graphs are the properties of Hangzhou Hikvision Digital Technology Co., Ltd. or its subsidiaries (hereinafter referred to be “Hikvision”). This user manual (hereinafter referred to be “the Manual”) cannot be reproduced, changed, translated, or distributed, partially or wholly, by any means, without the prior written permission of Hikvision. Unless otherwise stipulated, Hikvision does not make any warranties, guarantees or representations, express or implied, regarding to the Manual.

About this Manual

This Manual is applicable to Explosion-proof Network Positioning System e.

The Manual includes instructions for using and managing the product. Pictures, charts, images and all other information hereinafter are for description and explanation only. The information contained in the Manual is subject to change, without notice, due to firmware updates or other reasons. Please find the latest version in the company website (<http://overseas.hikvision.com/en/>).

Please use this user manual under the guidance of professionals.

Trademarks Acknowledgement

HIKVISION and other Hikvision’s trademarks and logos are the properties of Hikvision in various jurisdictions. Other trademarks and logos mentioned below are the properties of their respective owners.

Legal Disclaimer

TO THE MAXIMUM EXTENT PERMITTED BY APPLICABLE LAW, THE PRODUCT DESCRIBED, WITH ITS HARDWARE, SOFTWARE AND FIRMWARE, IS PROVIDED “AS IS”, WITH ALL FAULTS AND ERRORS, AND HIKVISION MAKES NO WARRANTIES, EXPRESS OR IMPLIED, INCLUDING WITHOUT LIMITATION, MERCHANTABILITY, SATISFACTORY QUALITY, FITNESS FOR A PARTICULAR PURPOSE, AND NON-INFRINGEMENT OF THIRD PARTY. IN NO EVENT WILL HIKVISION, ITS DIRECTORS, OFFICERS, EMPLOYEES, OR AGENTS BE LIABLE TO YOU FOR ANY SPECIAL, CONSEQUENTIAL, INCIDENTAL, OR INDIRECT DAMAGES, INCLUDING, AMONG OTHERS, DAMAGES FOR LOSS OF BUSINESS PROFITS, BUSINESS INTERRUPTION, OR LOSS OF DATA OR DOCUMENTATION, IN CONNECTION WITH THE USE OF THIS PRODUCT, EVEN IF HIKVISION HAS BEEN ADVISED OF THE POSSIBILITY OF SUCH DAMAGES.

REGARDING TO THE PRODUCT WITH INTERNET ACCESS, THE USE OF PRODUCT SHALL BE WHOLLY AT YOUR OWN RISKS. HIKVISION SHALL NOT TAKE ANY RESPONSIBILITIES FOR ABNORMAL OPERATION, PRIVACY LEAKAGE OR OTHER DAMAGES RESULTING FROM CYBER ATTACK, HACKER ATTACK, VIRUS INSPECTION, OR OTHER INTERNET SECURITY RISKS; HOWEVER, HIKVISION WILL PROVIDE TIMELY TECHNICAL SUPPORT IF REQUIRED.

SURVEILLANCE LAWS VARY BY JURISDICTION. PLEASE CHECK ALL RELEVANT LAWS IN YOUR JURISDICTION BEFORE USING THIS PRODUCT IN ORDER TO ENSURE THAT YOUR

USE CONFORMS THE APPLICABLE LAW. HIKVISION SHALL NOT BE LIABLE IN THE EVENT THAT THIS PRODUCT IS USED WITH ILLEGITIMATE PURPOSES.

IN THE EVENT OF ANY CONFLICTS BETWEEN THIS MANUAL AND THE APPLICABLE LAW, THE LATER PREVAILS.

Regulatory Information

FCC Information

Please take attention that changes or modification not expressly approved by the party responsible for compliance could void the user's authority to operate the equipment.

FCC compliance: This equipment has been tested and found to comply with the limits for a Class A digital device, pursuant to part 15 of the FCC Rules. These limits are designed to provide reasonable protection against harmful interference when the equipment is operated in a commercial environment. Operation of this equipment in a residential area is likely to cause harmful interference in which case the user will be required to correct the interference at his own expense.

FCC Conditions

This device complies with part 15 of the FCC Rules. Operation is subject to the following two conditions:

1. This device may not cause harmful interference.
2. This device must accept any interference received, including interference that may cause undesired operation

EU Conformity Statement



This product and - if applicable - the supplied accessories too are marked with "CE" and comply therefore with the applicable harmonized European standards listed under the EMC Directive 2014/30/EU, the RoHS Directive 2011/65/EU, and the ATEX Directive 2014/34/EU.



2012/19/EU (WEEE directive): Products marked with this symbol cannot be disposed of as unsorted municipal waste in the European Union. For proper recycling, return this product to your local supplier upon the purchase of equivalent new equipment, or dispose of it at designated collection points.

For more information see: www.recyclethis.info.



2006/66/EC (battery directive): This product contains a battery that cannot be disposed of as unsorted municipal waste in the European Union. See the product documentation for specific battery information. The battery is marked with this symbol, which may include lettering to indicate cadmium (Cd), lead (Pb), or mercury (Hg). For proper recycling, return the battery to your supplier or to a designated collection point. For more information see: www.recyclethis.info.

Industry Canada ICES-003 Compliance

This device meets the CAN ICES-3 (A)/NMB-3(A) standards requirements.

Intended Use of the Positioning System

⊕ Ex II 2 G Ex db IIC T6 Gb, Ta -40° C to +60° C

II 2 D Ex tb IIIC T80° C Db

Hazardous Area Classification: Zone 1, Zone 2, Zone 21, Zone 22

IP Degree: IP68 (2m, 2h)

Ex Standards:

IEC 60079-0: 2011	EN 60079-0: 2012/A11: 2013
IEC 60079-1: 2014	EN 60079-1: 2014
IEC 60079-31: 2013	EN 60079-31: 2014

Explosion-proof Positioning System Nameplate

Explosion-proof Positioning System	
Product Model: xxxxxxxxxxxxxxxxxxxxxx	
Protection Level: IP68	Temperature: -40°C~ +60°C
Working Voltage: AC100-240V	Working Current: ≤1000mA
Product No.: xxxxxxxxxxx	Date of Production: xxxxxx
TÜV 17 ATEX 8118	IECEx TUR 17.0049
 II 2 G Ex db IIC T6 Gb	Ex db IIC T6 Gb
 II 2 D Ex tb IIIC T80°C Db	Ex tb IIIC T80°C Db
	
WARNING:DO NOT OPEN WITH ENERGIZED	
CAUTION:USE FASTENERS WITH YIELD STRENGTH≥450MPa	
Hangzhou Hikvision Digital Technology Co., Ltd 555 Qianmo Road, Binjiang District, Hangzhou , China	



Safety Instruction

These instructions are intended to ensure that user can use the product correctly to avoid danger or property loss.

The precaution measure is divided into **Warnings** and **Cautions**:

Warnings: Neglecting any of the warnings may cause serious injury or death.

Cautions: Neglecting any of the cautions may cause injury or equipment damage.

	
Warnings Follow these safeguards to prevent serious injury or death.	Cautions Follow these precautions to prevent potential injury or material damage.



Warnings

- **Grounding:** The both internal and external earthing shall be connected reliably. Ground wire cross-sectional area of not less than the phase connector cross-sectional area level, at least 4mm².
- All the electronic operation should be strictly compliance with the electrical safety regulations, fire prevention regulations and other related regulations in your local region.
- Use the power adapter, which is provided by normal company. Refer to the product specification for the standard of the power adapter. The power consumption cannot be less than the required value.
- Do not connect several devices to one power adapter as adapter overload may cause over-heat or fire hazard.
- Make sure that the power has been disconnected before you wire or install the positioning system.
- When the product is installed on wall or ceiling, the device shall be firmly fixed.
- If smoke, odors or noise rise from the device, turn off the power at once and unplug the power cable, and then contact the service center.
- If the product does not work properly, contact your dealer or the nearest service center. Never attempt to disassemble the positioning system yourself. (We shall not assume any responsibility for problems caused by unauthorized repair or maintenance.)



Cautions

- If the positioning system fails to synchronize local time with that of the network, you need to set up the positioning system time manually. Visit the positioning system (via web browser or client software) and enter system settings interface for time settings.
- Do not drop the positioning system or subject it to physical shock, and do not expose it to high electromagnetism radiation. Avoid the equipment installation on vibrations surface or places subject to shock (ignorance can cause equipment damage).
- Do not place the positioning system in extremely hot, cold, dusty or damp locations, otherwise fire or electrical shock will occur. Refer to the product specification for the operating temperature.
- Exposing the device directly to sun light, low ventilation or heat source such as heater or radiator is forbidden (ignorance can cause fire danger).
- Use the provided glove when you open up the positioning system cover. Avoid direct contact with the positioning system cover, because the acidic sweat of the fingers may erode the surface coating of the cover.
- Use a soft and dry cloth when you clean inside and outside surfaces of the positioning system cover. Do not use alkaline detergents.
- Keep all wrappers after unpacking them for future use. In case of any failure occurred, you need to return the positioning system to the factory with the original wrapper. Transportation without the original wrapper may result in damage on the positioning system and lead to additional costs.

Table of Contents

1 Overview	1
1.1 Introduction	1
1.1.1 Power Supply	1
1.1.2 Explosion-proof Parameters.....	1
1.1.3 Mechanical Specification	1
1.1.4 Working Environment.....	1
1.2 Explanation of model naming.....	2
1.3 Cable Description	4
2 Installing the Positioning System	5
3 Setting the Positioning System over the LAN	7
3.1 Wiring.....	7
3.2 Activating the Positioning System.....	8
3.2.1 Activation via Web Browser	8
3.2.2 Activation via SADP Software.....	9
3.3 Modifying the IP Address	10
4 Accessing via Web Browser	11

1 Overview

1.1 Introduction

Explosion-proof Network Positioning System is designed with full consideration for explosion-proof effect. If the explosive gas mixture gets inside of the positioning system, the explosion-proof effect is guaranteed by several measures, including enclosure strength, width and length of the junction gap surfaces of components, limiting the highest temperature of the surface, etc.

Explosion-proof Network Positioning System is a surveillance product capable of video/audio collecting, smart encoding and network transmitting. It adopts an embedded system and a high-performed hardware process platform to achieve good stability and reliability. You can visit and configure your positioning system via web browser and client software.

Explosion-proof Network Positioning System adopts a stainless steel enclosure, receiving an IP68 rating for ingress protection. And the window adopts the tempered glass, which is able to stand shock and heat.

1.1.1 Power Supply

For detailed information about the power supply, refer to *Explosion-proof Positioning System Nameplate*.

1.1.2 Explosion-proof Parameters

For detailed information about explosion-proof parameters, refer to *Explosion-proof Positioning System Nameplate*.

1.1.3 Mechanical Specification

Material: 304/316L Stainless Steel

1.1.4 Working Environment

- Altitude (Above sea level): Within 2000 m.
- Humidity: Within 95%.
- Temperature: refer to *Explosion-proof Network System Nameplate*.

Note:

To ensure safety of the users and explosion-proof performance of the device, your installation environment must meet the installation requirements of the positioning system you purchased.

1.2 Explanation of model naming

The product can be named by rules in Figure 1-1.

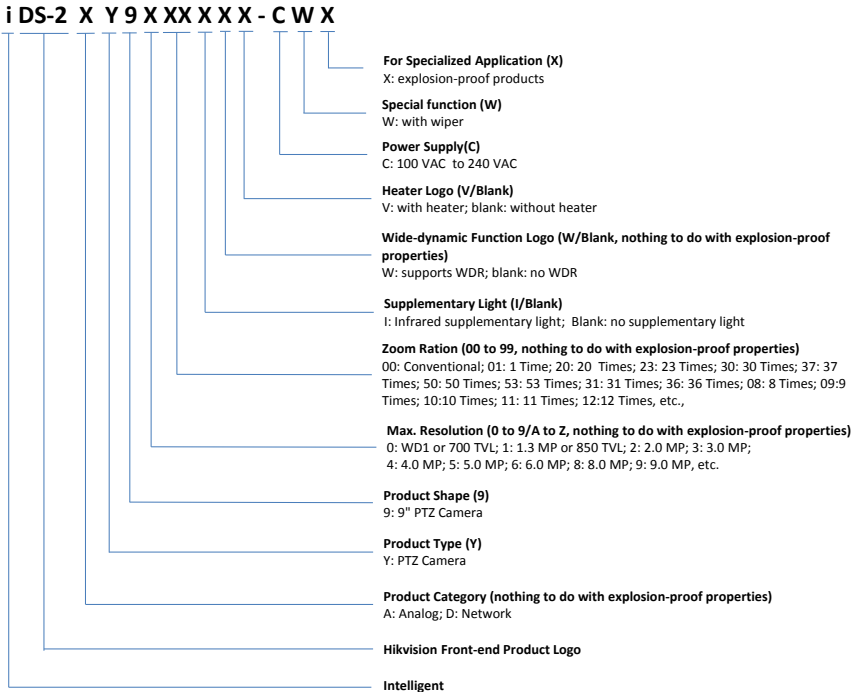
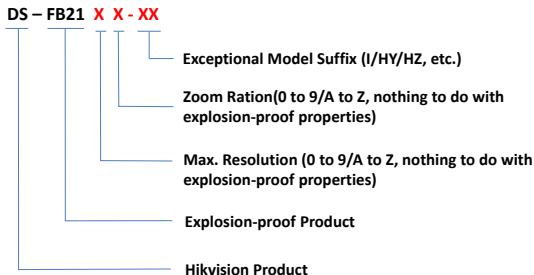

Figure 1-1 Product Naming Rule I



This manual is application to the models below:

DS-2DY9220-CWX	DS-2DY9230-CWX	DS-2DY9223-CWX
DS-2DY9237-CWX	DS-2DY9250-CWX	DS-2DY9253-CWX

DS-2DY9336-CWX	DS-2DY9831-CWX	DS-2DY9236-CWX
DS-2DY9100-CWX	DS-2DY9200-CWX	DS-2DY9300-CWX
DS-2DY9120-CWX	DS-2DY9130-CWX	DS-2DY9220-CWX
DS-2DY9230-CWX	DS-2DY9223V-CWX	DS-2DY9236W-CWX
DS-2DY9120W-CWX	DS-2DY9130W-CWX	DS-2DY9220W-CWX
DS-2DY9230W-CWX	DS-2DY9223W-CWX	DS-2DY9101-CWX
DS-2DY9201-CWX	DS-2DY9301-CWX	DS-2AY9001W-CWX
DS-2AY9000W-CWX	DS-2AY9023-CWX	DS-2AY9036-CWX
DS-2DY9220I-CWX	DS-2DY9230I-CWX	DS-2DY9223I-CWX
DS-2DY9250I-CWX	DS-2DY9253I-CWX	DS-2DY9336I-CWX
DS-2DY9831I-CWX	DS-2DY9236I-CWX	DS-2DY9120I-CWX
DS-2DY9130I-CWX	DS-2DY9220I-CWX	DS-2DY9230I-CWX
DS-2DY9223IV-CWX	DS-2DY9120IW-CWX	DS-2DY9130IW-CWX
DS-2DY9220IW-CWX	DS-2DY9223IW-CWX	DS-2DY9230IW-CWX
DS-2DY9236IW-CWX	DS-2DY9200I-CWX	DS-2DY9100I-CWX
DS-2DY9300I-CWX	DS-2DY9201I-CWX	DS-2DY9101I-CWX
DS-2DY9301I-CWX	DS-2AY9000I-CWX	DS-2AY9001I-CWX
DS-2AY9023I-CWX	DS-2AY9036I-CWX	DS-FB2116
DS-FB2127	DS-FB2126	DS-FB2128-LH
DS-FB212X-HY	DS-FB2116-I	DS-FB2127-I
DS-FB2126-I	iDS-2DY9253-CWX	iDS-2DY9237-CWX
iDS-2DY9253I-CWX	iDS-2DY9237I-CWX	iDS-2DY9225I-CWX

1.3 Cable Description

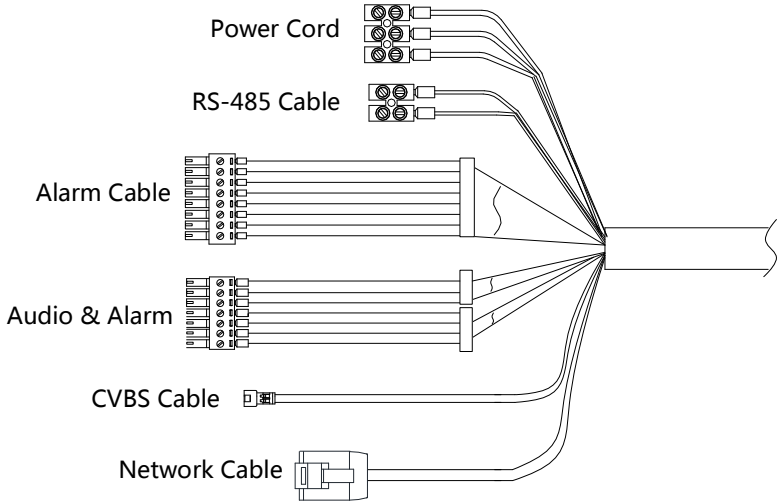

Figure 1-2 Cable Description

Note:

Cables vary depending on different positioning system models.

2 Installing the Positioning System

Before you start:

Check the package contents and make sure that the device in the package is in good condition and all the assembly parts are included.

Notes:

- Do not power the positioning system up until the installation is finished. To ensure the safety of personnel and device, all the installation steps should be done with power supply off.
- Make sure that there is enough space to install the device and accessories.
- Make sure that the wall is strong enough to withstand at least eight times the weight of the device and accessories.
- Carry the positioning system as shown in Figure 2-1.

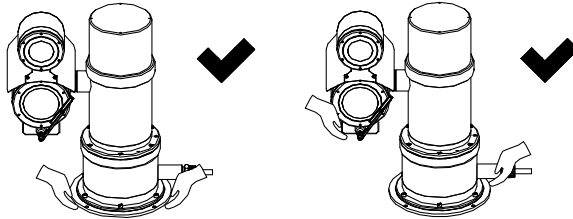

Figure 2-1 Carry the Positioning System

Steps:

1. Install the wall mounting bracket.
 - 1) Drill four $\text{Ø}16$ screw holes where you want to install the positioning system according to the holes on the bracket as shown in Figure 2-2.

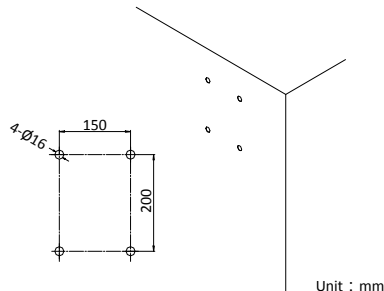

Figure 2-2 Drill Screw Holes

- 2) Insert four M12 expansion screws into the mounting holes through the holes on the bracket.

- 3) Secure the bracket with four flat gaskets, spring washers, and nuts as shown in Figure 2-3.

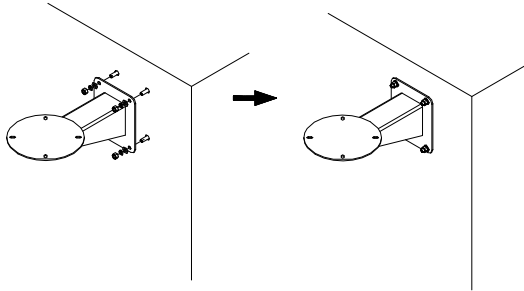

Figure 2-3 Secure the Bracket

2. Fix the positioning system to the bracket.
 - 1) Place the positioning system on the plate of wall mounting bracket.
 - 2) Align the four screw holes on the positioning system to the four screw holes on the bracket, and secure the positioning system with four M8×30 screws.

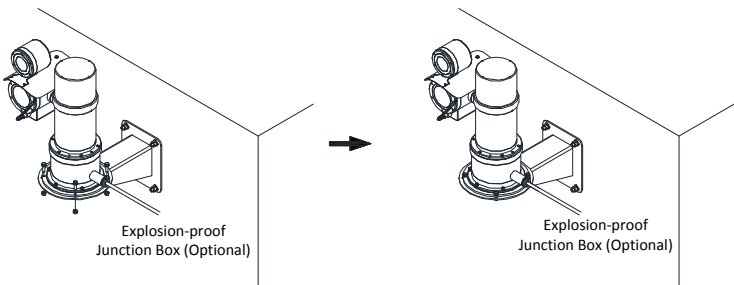

Figure 2-4 Fix the Positioning System

3 Setting the Positioning System over the LAN

Notes:

- You shall acknowledge that the use of the product with Internet access might be under network security risks. For avoidance of any network attacks and information leakage, strengthen your own protection. If the product does not work properly, contact with your dealer or the nearest service center.
- To ensure the network security of the positioning system, we recommend you to have the positioning system assessed and maintained termly. You can contact us if you need such service.

3.1 Wiring

To view and configure the network positioning system via LAN (Local Area Network), you need to connect the positioning system in the same subnet with your PC. Then, install the SADP or client software to search and change the IP address of network positioning system.

Connect the positioning system to network according to the following figures.

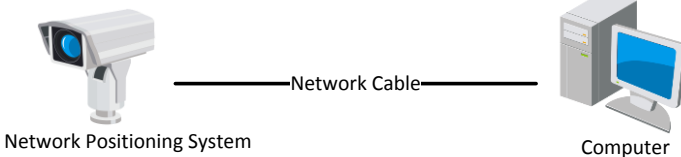

Figure 3-1 Connecting Directly

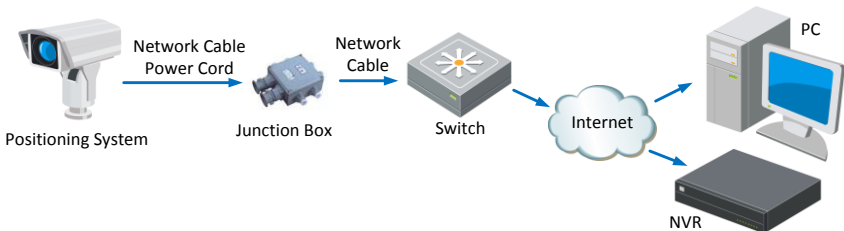

Figure 3-2 Wiring over LAN

3.2 Activating the Positioning System

Purpose:

You are required to activate the positioning system first by setting a strong password for it before you can use the positioning system.

Activation via web browser, activation via SADP, and activation via client software are supported. We will take activation via SADP software and activation via web browser as examples to introduce the positioning system activation.

3.2.1 Activation via Web Browser

Steps:

1. Power on the positioning system. Connect the positioning system to your computer or the switch/router which your computer connects to.
2. Input the IP address into the address bar of the web browser, and enter the activation interface.

Notes:

- The default IP address of the positioning system is 192.168.1.64.
- The computer and the positioning system should belong to the same subnet.
- For the positioning system enables the DHCP by default, you need to use the SADP software to search the IP address.

Figure 3-3 Activation Interface (Web)

3. Create a password and input the password into the password field.



STRONG PASSWORD RECOMMENDED– We highly recommend you create a strong password of your own choosing (Using a minimum of 8 characters, including at least three of the following categories: upper case letters, lower case letters, numbers, and special characters.) in order to increase the security of your product. And we recommend you reset your password regularly, especially in the high security system, resetting the password monthly or weekly can better protect your product.

4. Confirm the password.

- Click **OK** to activate the positioning system and enter the live view interface.

3.2.2 Activation via SADP Software

SADP software is used for detecting the online device, activating the device, and resetting the password.

Get the SADP software from the supplied disk or the official website, and install the SADP according to the prompts.

Follow the steps to activate the positioning system.

Steps:

- Run the SADP software to search the online devices.
- Check the device status from the device list, and select an inactive device.

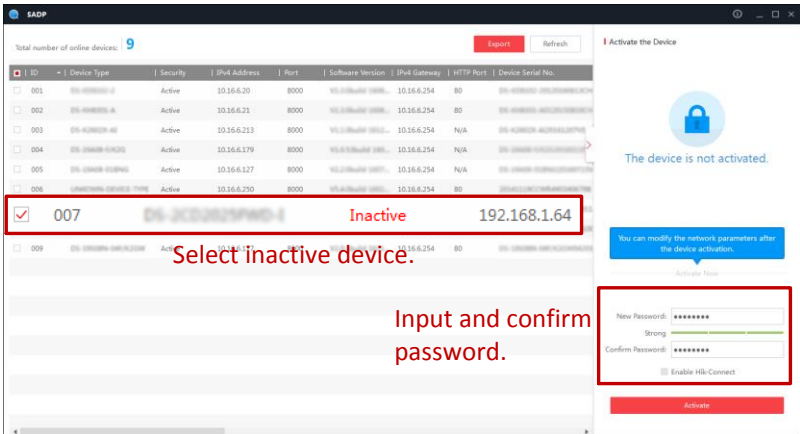

Figure 3-4 SADP Interface

Note:

The SADP software supports activating the positioning system in batch. Refer to the user manual of SADP software for details.

- Create a password and input the password in the password field, and confirm the password.



STRONG PASSWORD RECOMMENDED— We highly recommend you create a strong password of your own choosing (Using a minimum of 8 characters, including at least three of the following categories: upper case letters, lower case letters, numbers, and special characters.) in order to increase the security of your product. And we recommend you reset your password regularly, especially in the high security system, resetting the password monthly or weekly can better protect your product.

- Click **Activate** to save the password.

Note:

You can check whether the activation is completed on the popup window. If activation failed, make sure that the password meets the requirement and try again.

3.3 Modifying the IP Address

Purpose:

To view and configure the positioning system via LAN (Local Area Network), you need to connect the network positioning system in the same subnet with your PC.

Use the SADP software or client software to search and change the IP address of the device. We take modifying the IP Address via SADP software as an example to introduce the IP address modification.

Note:

For IP address modification via client software, refer to the user manual of client software.

Steps:

1. Run the SADP software.
2. Select an active device.
3. Change the device IP address to the same subnet with your computer by either modifying the IP address manually or checking **Enable DHCP**.
4. Input the admin password and click **Modify** to activate your IP address modification. The batch IP address modification is supported by SADP. Refer to the user manual of SADP for details.

4 Accessing via Web Browser

System Requirement:

Operating System: Microsoft Windows XP SP1 and above version/Vista/Win7/Server 2003/Server 2008 32bits

CPU: Intel Pentium IV 3.0 GHz or higher

RAM: 1G or higher

Display: 1024 × 768 resolution or higher

Web Browser: Internet Explorer 8 to 11, Google Chrome 31 to 44, and Mozilla Firefox 30 to 51

Steps:

1. Open the web browser.
2. In the browser address bar, input the IP address of the network positioning system, and enter the login interface.

Note:

The default IP address is 192.168.1.64. You are recommended to change the IP address to the same subnet with your computer.

3. Input the user name and password.

The admin user should configure the device accounts and user/operator permissions properly. Delete the unnecessary accounts and user/operator permissions.

Note:

The device IP address gets locked if the admin user performs 7 failed password attempts (5 attempts for the user/operator).

4. Click **Login**.



Figure 4-1 Login Interface

5. Install the plug-in before viewing the live video and managing the network positioning system. Follow the installation prompts to install the plug-in.

Note:

You may have to close the web browser to finish the installation of the plug-in.

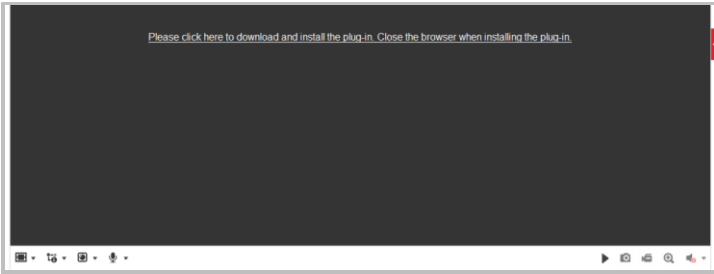

Figure 4-2 Download Plug-in

6. Reopen the web browser after the installation of the plug-in and repeat the above step 2 to step 4 to login.

Note:

For detailed instructions of further configuration, refer to the user manual of network positioning system.

