

WebRelay-IO™

Users Manual

Covers:

X-WR-10R12-I
X-WR-10R12-IP

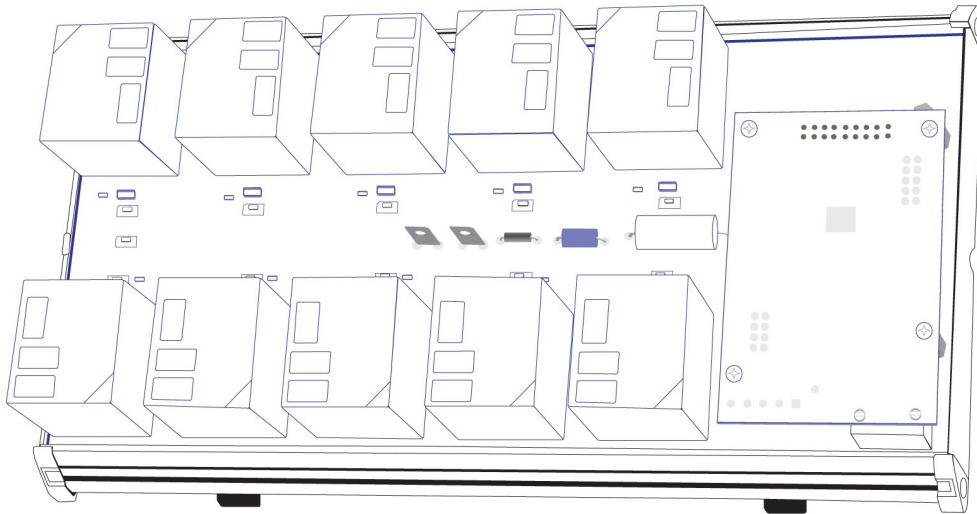

CONTROL by
WEB™
www.ControlByWeb.com

a division of...
Xytronix Research & Design, Inc.
Nibley, Utah, USA

Table of Contents

Section 1: Introduction	4
1.1 Features.....	5
1.2 Applications.....	5
1.3 WebRelay-10 Models Available.....	6
1.4 Connectors & Indicators.....	7
1.5 Accessing WebRelay-10.....	8
Section 2: Installation and Setup	9
2.1 Mounting.....	10
2.2 Connections.....	11
2.3 Establishing Communications for Setup.....	16
2.4 WebRelay-10 Setup Pages	21
Section 3: Operation	54
3.1 Browser Operation.....	54
3.2 XML Operation.....	56
3.3 Configuring Events Through GET Requests (WebRelay-10 Plus™ only).....	61
3.4 Modbus Operation.....	63
3.5 Email Notification.....	78
Appendix A: Restoring Factory Default Settings	80
Appendix B: Installing New Firmware	81
Appendix C: Accessing WebRelay-10™ Over the Internet	83
Appendix D: Log Files (WebRelay-10 Plus™ only)	87
Appendix E: External Server and Remote Services	90
Appendix F: SNMP Requests, Objects and Community Strings	92
Appendix G: BASIC Scripts	95
Appendix H: Specifications	101
Appendix I: Warranty	104
Appendix J: FCC Statement	105
Appendix K: Trademark and Copyright Information	106
Appendix L: Mechanical Information	107

WebRelay-10 User Manual Revisions	
Revision	Description
2.6	Changed input voltage specification from 10-36VDC to 9-28VDC Updated power requirements for 9-28VDC operation Changed relay contact specification from 30amps to 15amps Moved warranty and trademark information to the appendix Changed warranty to 5-years
2.7	Clarified relay specifications

Section 1: Introduction

WebRelay-10™ is a robust, 10-relay module with a built-in web server. It can be controlled and/or monitored over any IP network including private networks, IP-based industrial control networks, and the Internet. Users can operate WebRelay-10 using a web browser or a custom application. Computers, PLCs, or automation controllers may control and monitor WebRelay-10 without user intervention. This works by sending text commands over the network and reading XML status pages from WebRelay-10, or by using Modbus/TCP protocol.

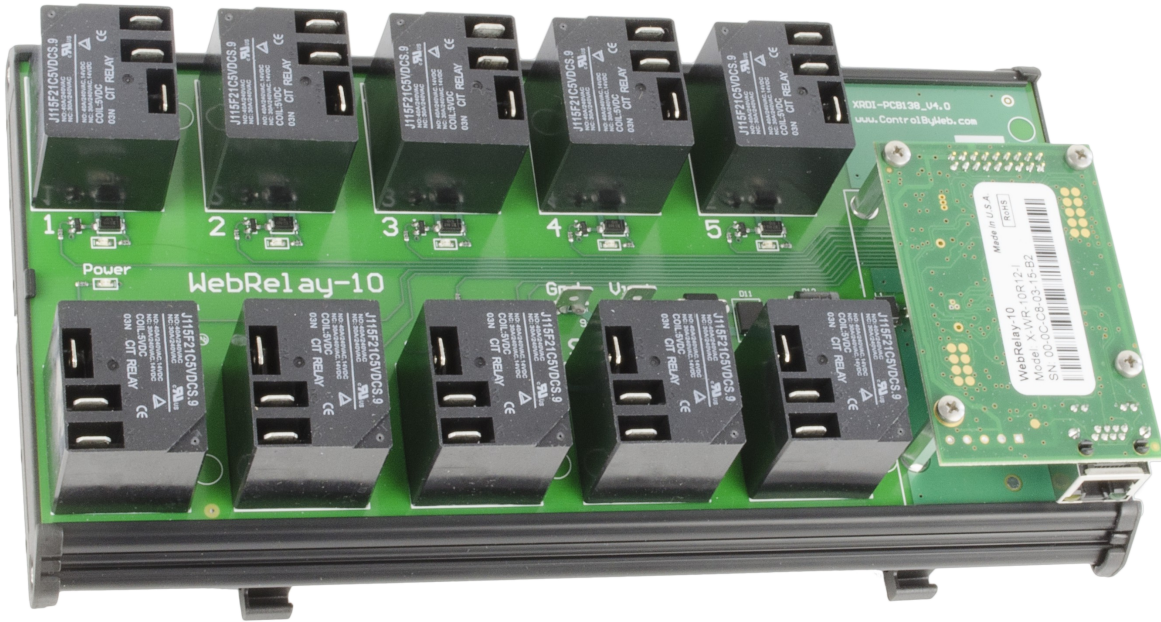

1.1 Features

WebRelay-10 includes the following features:

- Ten independent 15-Amp Relays (Form C, SPDT).
- Built-in Web server for browser-based setup and control.
- No special software or device drivers required.
- Customizable email alerts.
- XML status and **Control Page** make communications with custom computer applications simple.
- Can operate as a Modbus/TCP slave.
- On/Off and Pulse modes.
- Advanced functionality through BASIC scripts.
- Wide power supply range (9-28 VDC).
- DIN-Rail Mountable.
- LED relay state indicators.
- ¼ inch tab-connectors.
- UL/CUL listed relays (E197852).

WebRelay-10 Plus™ (Model X-WR-10R12-IP) also includes the following features:

- Event scheduler with yearly calendar. Schedule up to 100 events.
- Up to eight temperature and/or humidity sensors can be added for environmental monitoring.
- Dry-contact sensors or switches can be connected for local control of relays or for monitoring external devices.
- Logging: log relay changes, events, Modbus requests, high/low temperatures, input changes, network traffic, and more.
- Real-time clock, can automatically adjust for daylight savings time, **Sync with NTP server**.
- System log provides detailed diagnostic information.
- Configure manually or with DHCP.

Note: WebRelay-10 sends out email messages only. Most wireless carriers provide free services to convert email messages to text messages.

1.2 Applications

WebRelay-10 has many applications. It works very well as a stand-alone device that can be controlled using a web browser, or as a convenient way to add I/O to a computer. It can be used in industrial applications to control motors, lights, coils, pumps, valves, etc.

Using the additional features found on WebRelay-10 Plus™, you can monitor temperature and/or humidity, control multiple relays using an input, schedule reoccurring events, log relay state changes, and much more.

1.3 WebRelay-10 Models Available

WebRelay-10 is currently available in two models. The main differences between each model are listed below.

X-WR-10R12-I	Standard WebRelay-10 with built-in web server, and ten individually controlled relays.
X-WR-10R12-IP (WebRelay-10 Plus)	WebRelay-10 Plus™ includes all features of standard model plus temperature/humidity monitoring (humidity monitoring requires optional humidity sensor), discrete inputs, real-time clock, event scheduling, capacitor power backup, and logging.

1.3.1 Optional Accessories (WebRelay-10 Plus)

Accessory	Description	Part Number
Temperature Sensor	Digital temperature sensor with 12 inch wire leads. Note: Leads may be extended	X-DTS-U
Temperature Sensor (Wall Mount)	Digital temperature sensor housed in vented plastic enclosure	X-DTS-WM
Temperature/Humidity Sensor (Wall Mount)	Digital temperature and humidity sensor housed in vented plastic enclosure.	X-DTHS-WM

1.4 Connectors & Indicators

Version H (Newest version) – Gnd and Vin+ pin position moved from version 2.3

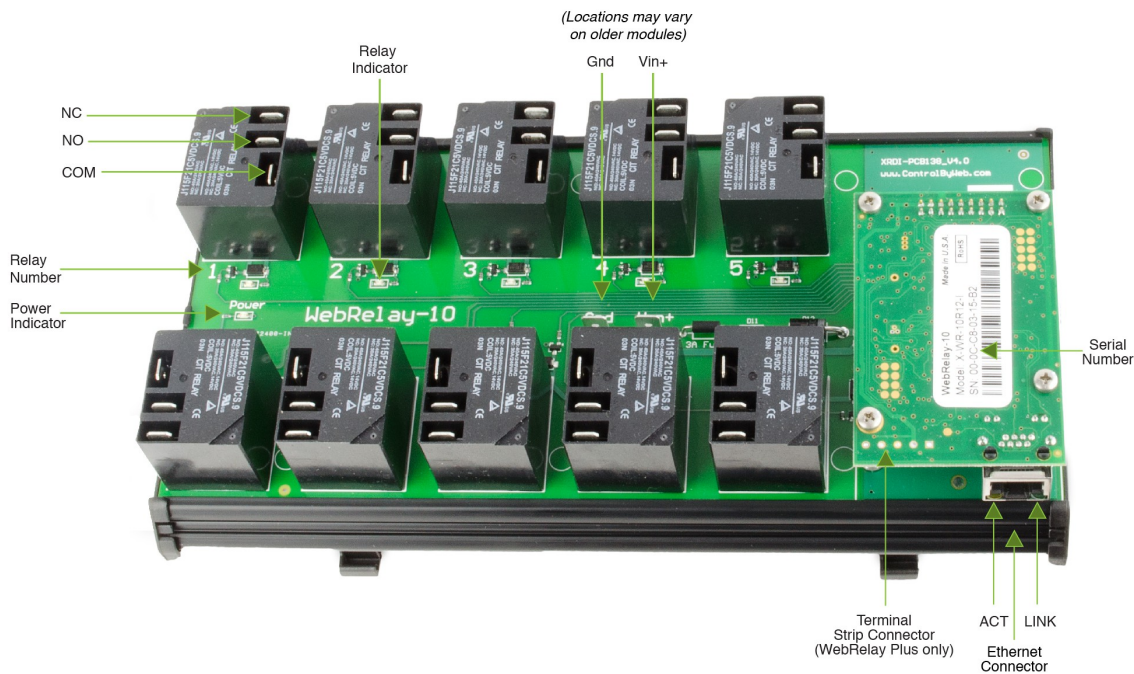

Figure 1.4a - Connections & Indicators

Version G (Older version)



Module Power Connectors

Two 1/4" tab connectors located on the circuit board are used to apply power to the module.

Relay Connectors

Each relay has three 1/4" tab connectors for common, normally open, and normally closed contacts. Female mating connectors (not included) are required for connecting user circuits.

Network Connector

The Ethernet connector is located on a small CPU daughter card that is mounted to the main relay board.

I/O Connector

WebRelay-10 Plus™ includes a 5-position removable terminal connector for discrete inputs and temperature and/or humidity sensors.

Relay Indicators

Ten green LEDs indicate when each relay is energized. The LEDs are located next to the corresponding relays. When the relay is energized, the common and normally open contacts are closed. When the relay is not energized, the common and normally closed contacts are closed.

Module Power Indicator

The green power LED indicator is located on the main relay board in between relays 1 and 6.

Ethernet Indicators

The LINK LED is illuminated green when the module is properly connected to an Ethernet network and is ready to communicate. Network communications will only occur if this LED is illuminated. The ACT LED flashes amber when activity is detected on the network.

1.5 Accessing WebRelay-10

Standard Access Using a Web Browser

WebRelay-10 has a built-in web server that provides simple web pages that can be accessed directly using a standard web browser. This allows users to access the unit with NO SPECIAL SOFTWARE installed on their computer. This is ideal for applications that require a quick, simple solution that does not need to be accessible to more than a few people. This configuration is simple to setup, simple to use, and can be accessed from any computer.

*Note: Network routers may need to be configured to allow access from computers outside of the local network (see **Appendix C: Accessing WebRelay-10™ Over The Internet**).*

Section 2: Installation and Setup

Installation consists of mounting WebRelay-10, connecting it to an Ethernet network, providing power, configuring via a web browser, and wiring relay contacts to the device that will be controlled.

For WebRelay-10 Plus™ models, inputs and sensors can be wired to the device using the 5-position terminal connector.

Installation Guidelines (Read Before Installing)

- This unit must be installed by qualified personnel.
- This unit must not be installed in unprotected outdoor locations.
- The WebRelay-10 must be installed inside an NRTL certified industrial control panel or similar NRTL certified fire/electrical enclosure.
- If the WebRelay-10 is used in a manner not specified by Xytronix, the protection provided by the equipment may be impaired.
- This unit must not be used for medical, life saving purposes, or for any purpose where its failure could cause serious injury or the loss of life.
- This unit must not be used in any way where its function or failure could cause significant loss or property damage.
- The relay tab terminals are 1/4" x .032". Use UL listed quick-connect connectors suitable for field connections. Use a suitable crimping tool as specified by the connector manufacturer. Use wire rated for 75°C (min) for connections to the relays.

Security Notes

WebRelay-10 does not employ a general purpose computer operating system and does not have features, such as telnet, FTP, SSH, nor uncontrolled open ports. This means it is unlikely for someone to 'break in' to WebRelay-10 and access other devices on your local network. The simplicity of WebRelay-10 makes it an inherently secure device. Nevertheless, as with any device installed on a network, appropriate security precautions should be observed.

If WebRelay-10 is installed on the Internet, it is recommended that passwords be enabled for the **Control Page**. Passwords should be at least 8 characters in length and use a combination of upper and lower case letters and numbers. For additional security, a firewall may be used to limit access to selected IP addresses. Another option may be to set up a Virtual Private Network (VPN) between the network where WebRelay-10 resides and the client machine (web browser, another, ControlByWeb™ product, etc.).

Final Installation Notes

This ControlByWeb™ product supports connection to **10 Mbps** and **100 Mbps** networks. Although 100Mbps networks are faster, the amount of data transferred to and from this device is very minimal and little, if any, performance increase will be gained by setting it to **100 Mbps**. There are advantages, however, to operate this device at **10 Mbps**. At **10 Mbps**, less power is required, the unit runs cooler, and the lifetime of the product will be extended.

Any changes to the Ethernet settings will require a removing and re-applying power to WebRelay-10.

2.1 Mounting

WebRelay-10 can be mounted to a standard (35mm by 7.55mm) DIN-Rail. Attach the module to the DIN-Rail by placing the top hooks on the back of WebRelay-10 to the DIN-Rail and then snapping the bottom hooks into place. Remove from the DIN-Rail by depressing the latch-release on the mounting bracket.

See **Appendix L: Mechanical Information** for additional mechanical details.



Figure 2.1a - DIN-Rail Mount

2.2 Connections

CAUTION: MAKE SURE POWER IS SHUT OFF BEFORE WIRING!

CAUTION: THIS UNIT SHOULD BE INSTALLED BY A QUALIFIED TECHNICIAN.

MIS-WIRING OR MIS CONFIGURATION COULD CAUSE PERMANENT DAMAGE TO THE WebRelay-10 AND/OR THE EQUIPMENT TO WHICH IT IS CONNECTED.

Relay connections are made through the ¼ inch male tab connectors. Mating connectors (¼ inch female tab connectors) can be purchased at electrical supply stores.

It is recommended that the load (device to be controlled) not be connected to WebRelay-10 until after WebRelay-10 has been configured and tested. By doing this, wiring and configuration mistakes will not cause the attached devices to turn on unexpectedly.

IMPORTANT: WIRES SHOULD BE PROPERLY CRIMPED TO THE CONNECTORS, AND CONNECTORS SHOULD BE PROPERLY ATTACHED TO THE CIRCUIT BOARD OR RELAYS!

2.2.1 Power Supply Connection

WebRelay-10 requires power for its internal logic circuits. Connect a 9-28VDC power supply to the Vin+ and Gnd terminals. Note that a regulated power supply is recommended, such as a wall-mount AC-DC adapter. Verify that the adapter is rated for the operating current of WebRelay-10 (See **Appendix H: Specifications** for current requirements.)

Multiple WebRelay-10 units may be connected to a single power supply by connecting the power supply input terminals in parallel. The power supply must have a high enough current rating to power all units connected. (See **Appendix H: Specifications** for current requirements.)

The power input tab terminals are 1/4" x .032". Use UL listed quick-connect connectors suitable for field connections. Use a suitable crimping tool as specified by the connector manufacturer. Use wire rated for 75°C (min) for the power connections.

2.2.2 Relay Connection

Direct connection to relay contacts is provided through tab connectors located on the top of the relays. Do not exceed the specified load ratings for relay contacts (see **Appendix H: Specifications** for load ratings). The relay tab terminals are 1/4" x .032". Use UL listed quick-connect connectors suitable for field connections. Use a suitable crimping tool as specified by the connector manufacturer. Use wire rated for 75°C (min) for connections to the relays.

2.2.3 Network Connection

Connect the Ethernet port to a 10 Base-T or 10/100 Base-T Ethernet connection. This typically connects to an Ethernet hub, switch, or router. For configuration, WebRelay-10 may be connected directly to the Ethernet port on a computer using a "crossover" cable. Otherwise, for connection through a hub or router, a standard "straight-through" cable should be used.



Figure 2.2a - Network Connection

WebRelay-10 can be used on a wireless network by connecting through an Ethernet bridge or a wireless router. WebRelay-10 is connected directly to the wireless device.

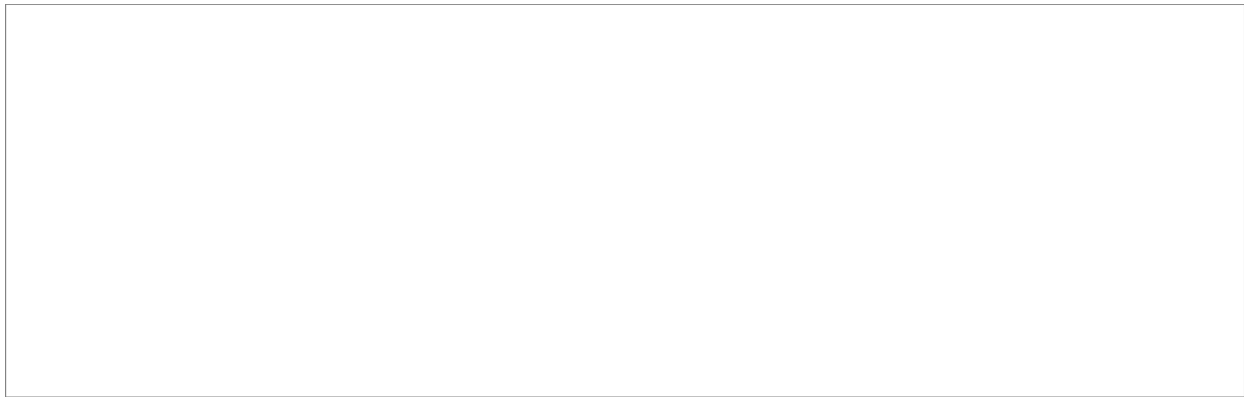

Figure 2.2b - Wireless Connection

Note: The wireless Ethernet bridge or router must be properly configured for the wireless network. Refer to the installation instructions for the wireless device. Terminal Connector (WebRelay-10 Plus™ only)

The removable 5-position terminal connector is used for connecting temperature sensors, humidity sensors, or discrete inputs. The terminals are described in the table below.

IMPORTANT: MAKE SURE WIRES ARE PROPERLY ATTACHED TO THE TERMINALS AND THAT THE SCREW TERMINALS ARE TIGHT!

5-pin connector pinout	
Pin	Description
Data	Temperature/Humidity Data. This is the data line connection for the digital temperature/humidity sensors.
+5V Out	This output voltage is used to provide power for the digital temperature/humidity sensors.
Ground	Ground connection for 5VDC output, and Inputs.
Input 1 & 2	Discrete Inputs.



Figure 2.2c - Connector Pinout

Input Connection (WebRelay-10 Plus™ only)

Two discrete inputs can be connected to dry contact sensors or switches. Third party sensors can be used for monitoring alarm conditions such as door access switches or transducer thresholds. Inputs can also be used for operator switches and the unit can be configured such that they control the relays.

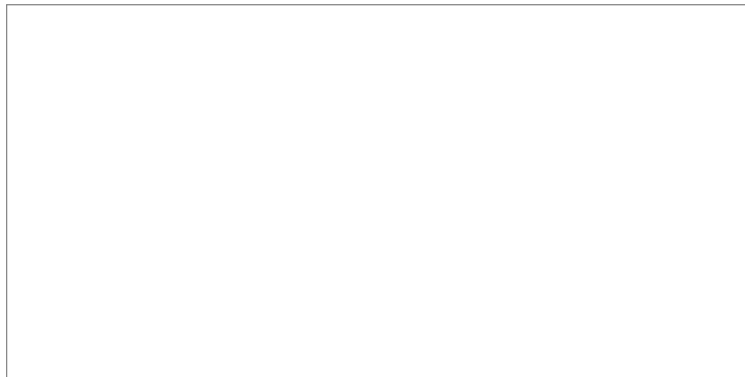

Figure 2.2d - Input Schematic

Connect one terminal of sensor or switch to the input terminal (Input 1 or Input 2). Connect the other terminal to the ground terminal on WebRelay-10 Plus™. When contacts are closed the input is connected to ground and the input is considered to be **ON**. Switch current is less than 2 mA.

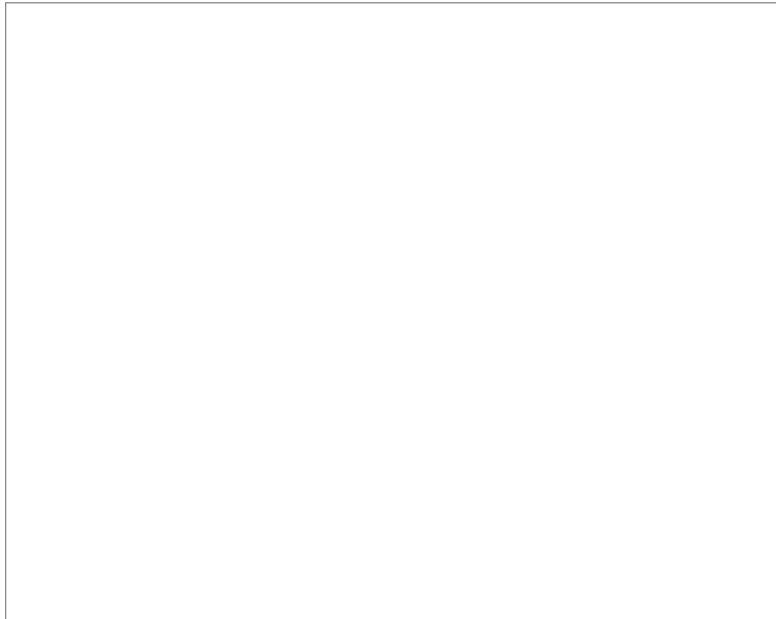

Figure 2.2e - Input Connector

Temperature/Humidity Sensor Connection (WebRelay-10 Plus™ only)

Temperature and/or humidity sensors can be used for monitoring environmental conditions. The digital sensors use a one-wire data bus, which allows up to eight sensors to share the same terminals (+5V, Ground, Data). Every sensor on the one-wire bus is assigned a unique serial number when it is manufactured. That number is used to address the device during communication.

The sensors have three wires; the wire color is show in the table below.



Figure 2.2f - Temperature Sensor

Sensor Wire Color	Connection
Red	Vout
Black	Gnd
Blue (or White)	Data

Multiple sensors can be connected in two ways, directly connected to the unit (star topology) or “daisy chained” (linear topology) as shown in Figure 2.2g.

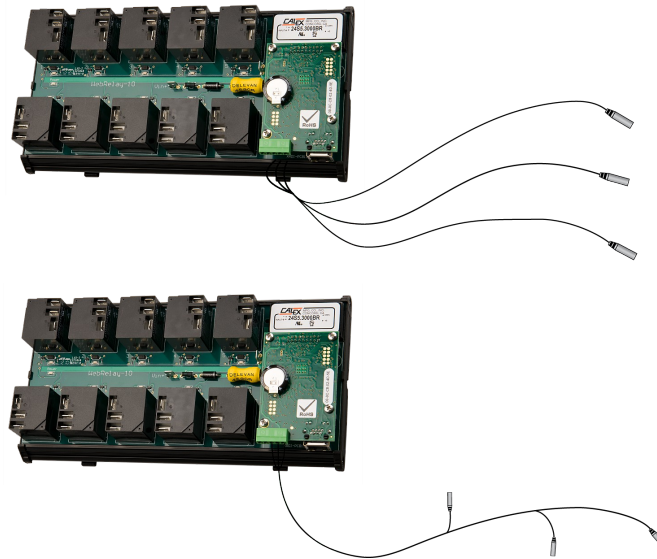

Figure 2.2g - Direct Connection (Star) and Daisy Chain Connection(Linear)

Many factors will determine the maximum length of cable used to connect sensors to WebRelay-10 Plus™. Some of these factors include, but are not limited to, the type of cable used, the number of sensors, ambient electromagnetic noise, and sensor network topology. Combined cable lengths to all sensors of 600 ft using Cat 5e cable have been successful. However, due to the uniqueness of installation environments, results may vary. Please test in the desired environment before permanent installation.

The following are general recommendations that will maximize sensor runs and minimize problems. Cat 5 and Cat 5e network cable has proven to be an effective and low-cost solution for long runs. Other cable types can be used, but cable capacitance may limit the length. Figure 2.2h shows the recommended connection using Cat 5 network cable.

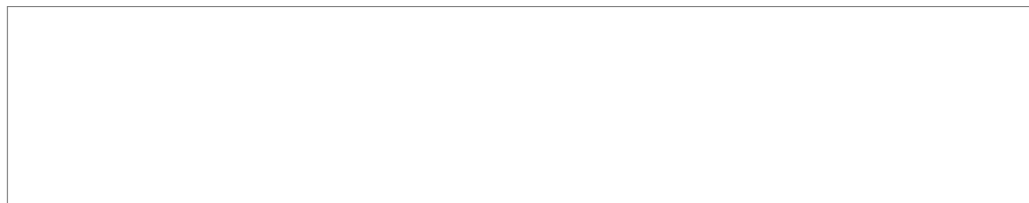

Figure 2.2h - Recommended connection using Cat 5 cable

A linear (daisy chain) rather than a star (direct connection) topology will minimize signal reflections. Appropriate strain relief should be used at the WebRelay-10 and other connections that may be subjected to vibration, movement, or repeated handling.

The 1-wire bus is "single-ended" and has no intrinsic noise protection. It is susceptible to interference if the cable is routed near power lines, fluorescent fixtures, motors or other noise sources. Keep the cable wiring short and avoid routing it near other electrical equipment.

Protect any electrical connections with appropriate weather shielding.

Due to the broad range of applications and environments where the WebRelay-10 may be employed, installation success on long sensor runs may vary significantly.

2.3 Establishing Communications for Setup

In order to configure WebRelay-10 with the web browser interface, WebRelay-10 must be connected to an Ethernet computer network. This can be done by one of two methods:

Method 1 – Assign a temporary IP address of WebRelay-10 to work on an existing network.

-or-

Method 2 – Temporarily change the IP address of a connected computer to the match the default IP address used by WebRelay-10.

Note: If multiple ControlByWeb™ products are used on the same network, install one at a time and set the IP address of each unit before connecting the next unit to the network. This avoids having multiple devices being installed on the network with the same factory default IP address at the same time. If this approach is used, be sure to clear the arp cache after disconnecting each unit (arp -d).

2.3.1 Method 1: Assign a Temporary IP address to WebRelay-10

This option is used to TEMPORARILY assign an IP address to WebRelay-10 without the need to change the IP address of the configuration computer. WebRelay-10 will use this IP address as long as power is maintained. Once power is lost, WebRelay-10 will use the IP address assigned in the setup page and not the temporary address assigned here.

Make sure that WebRelay-10 and the configuration computer are connected to the same network.

This will not work through routers or gateways.

Microsoft Windows Instructions

1. Open a Command Prompt (select START, then RUN, then type “cmd”).

Note: For Vista, the Command Prompt should be run as administrator (select Start, then type “cmd” and right click on “cmd” and select “Run as administrator”).

2. Type:

```
arp -s {new IP address} {serial number of WebRelay-10 }
```

Note: IP address format is xxx.xxx.xxx.xxx. The serial number can be found on a label on the module board. The format is ss-ss-ss-ss-ss-ss.

For example, to set WebRelay-10 (with serial number 00-0C-C8-01-00-01) to 10.10.10.40 the following command would be used:

```
arp -s 10.10.10.40 00-0c-c8-01-00-01
```

3. Next, type:

```
ping -l 102 {new IP address}
```

For example, if the new IP address is 10.10.10.40, the following command would be used:

```
ping -l 102 10.10.10.40
```

4. Proceed with WebRelay-10 setup in section 2.4.

Once setup is complete, it may be necessary to clear the 'arp' cache to configure additional WebRelays. This is necessary because each unit has the same default IP address, but a different unit serial number (MAC address). Clearing the arp table can be done by typing `arp -d` in the command prompt window.

Linux/Unix Instructions

1. Open a terminal and change to root user (su -, then enter root password).

2. Type:

```
arp -s {new IP address} {serial number of WebRelay-10 }
```

Note: IP address format is xxx.xxx.xxx.xxx. The serial number can be found on a label on the module board. The format is ss:ss:ss:ss:ss:ss.

For example, to set WebRelay-10 (with serial number 00-0C-C8-01-00-01) to 10.10.10.40 the following command would be used:

```
arp -s 10.10.10.40 00:0c:c8:01:00:01
```

3. Next, type:

```
ping -s 102 {new IP address}
```

For example, if the new IP address is 10.10.10.40, the following command would be used:

```
ping -s 102 10.10.10.40
```

4. Proceed with WebRelay-10 setup in section 2.4.

Once setup is complete, it may be necessary to clear the 'arp' cache to configure additional WebRelays. This is necessary because each unit has the same default IP address, but a different unit serial number (MAC address). Clearing the arp table can be done by typing `sudo arp -d -a` in the command prompt window.

Mac OS X Instructions

1. Open a terminal.

Note: The terminal is in the "Utilities" directory, which is in the "Applications" directory.

2. Type:

```
sudo arp -s {new IP address} {serial number of WebRelay-10 }
```

Administrator password may be required.

Note: IP address format is xxx.xxx.xxx.xxx. The serial number can be found on the label on the module board. The format is ss:ss:ss:ss:ss:ss.

For example, to set a WebRelay-10 (with serial number 00-0C-C8-01-00-01) to 10.10.10.40 the following command would be used:

```
sudo arp -s 10.10.10.40 00:0c:c8:01:00:01
```

3. Next, type:

```
ping -s 102 {new IP address}
```

For example, if the new IP address is 10.10.10.40, the following command would be used:

```
ping -s 102 10.10.10.40
```

4. Proceed with WebRelay-10 setup in section 2.4.

Once setup is complete, it may be necessary to clear the 'arp' cache to configure additional WebRelays. This is necessary because each unit has the same default IP address, but a different unit serial number (MAC address). Clearing the arp table can be done by typing `sudo arp -d -a` in the command prompt window.

2.3.2 Method 2: Assign a Temporary IP Address to Configuration Computer

If the first option above is not used, you can use this option to communicate with WebRelay-10. By default, WebRelay-10 comes from the factory with an IP address of 192.168.1.2. Communications with WebRelay-10 may be established by assigning an IP address to the configuration computer that is on the same network as WebRelay-10 (for example, the configuration computer could be assigned to 192.168.1.50)

The following example is for those running the Windows operating system:

1. Windows XP – Open the control panel by clicking on the start menu and then on Control Panel.

Windows Vista/7 – Select the Windows Icon (Start Menu) and enter `ncpa.cpl` into the search bar and press Enter (Figure 2.3a).

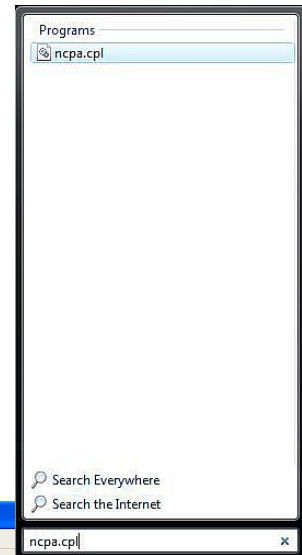

Figure 2.3a- Vista/7 Start Menu

Note: The control panel shown (Figure 2.3b) is in "Classic View." If the control panel is in "Category View," select the "Classic View" option before proceeding.

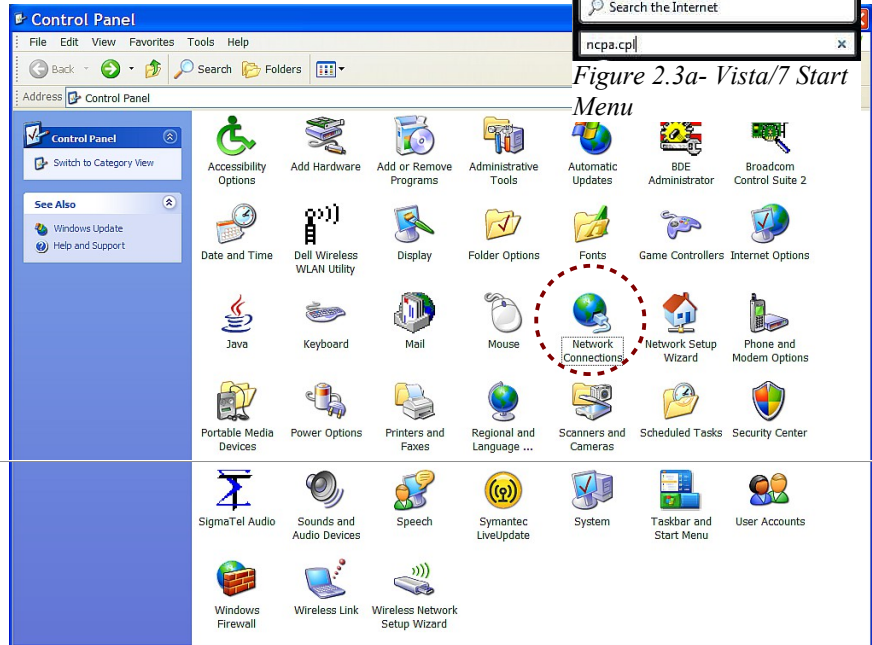

Figure 2.3b- Control Panel

2. Double click on the icon labeled Network Connections. The Network Connections window will open (Figure 2.3c).

3. Right click on the icon labeled Local Area Connection. In the menu that follows, select the option at the bottom of the menu labeled Properties. The Local Area Connection Properties window will appear (Figure 2.3c).

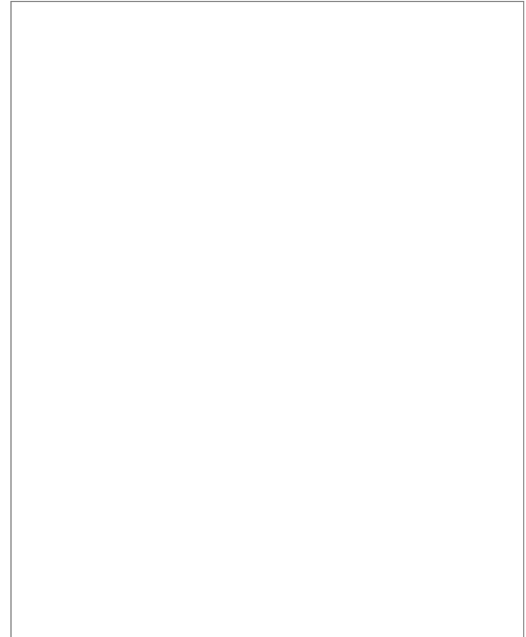

Figure 2.3d- Local Area Connection

4. In the Local Area Connection Properties window in the Connection Uses box, scroll down and highlight "Internet Protocol (TCP/IP)." Click the button labeled "Properties." The "Internet Protocol (TCP/IP)" Properties menu appears (Figure 2.3e).

5. Select the radio button labeled "Use the following IP address" and type in the IP address:

192.168.1.50

6. Type in the subnet mask:

255.255.255.0

No need to change the default gateway field. Click OK to accept the new settings.

Note: If "Use the following IP address" is already selected, the computer has been set up with a static IP address. Record these values so that the computer can be restored once the IP address of WebRelay-10 is successfully changed.

7. Open the setup pages as described in section 2.4. If the setup pages are not accessible, verify that WebRelay-10 is powered on and that the LINK light is illuminated. Check all network connections and settings.

Another way to check communications is to ping WebRelay-10 (from the command prompt by typing ping {WebRelay-10 IP address}).

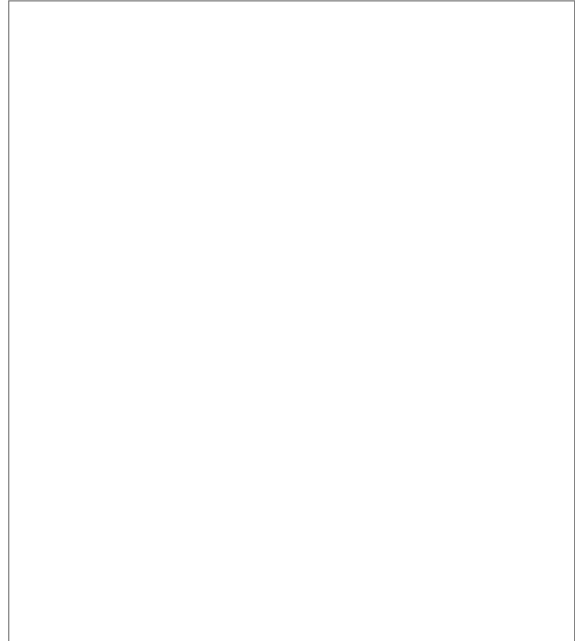

Figure 2.3e- TCP/IP Properties

2.4 WebRelay-10 Setup Pages

WebRelay-10 is configured using a web browser. To access the setup pages, enter the following URL in the address bar of a web browser:

```
http://{ipaddress}/setup.html
```

For example, using the default IP address, enter:

```
http://192.168.1.2/setup.html
```

After the page is requested, a password prompt will appear. Enter the username and password. The default username is `admin` and the default password is `webrelay` (password is case sensitive).

2.4.1 Main Tab

This is the initial page that is displayed when `setup.html` is entered into the address bar of the browser. It displays model and serial number information, and allows the user to select the desired temperature units.

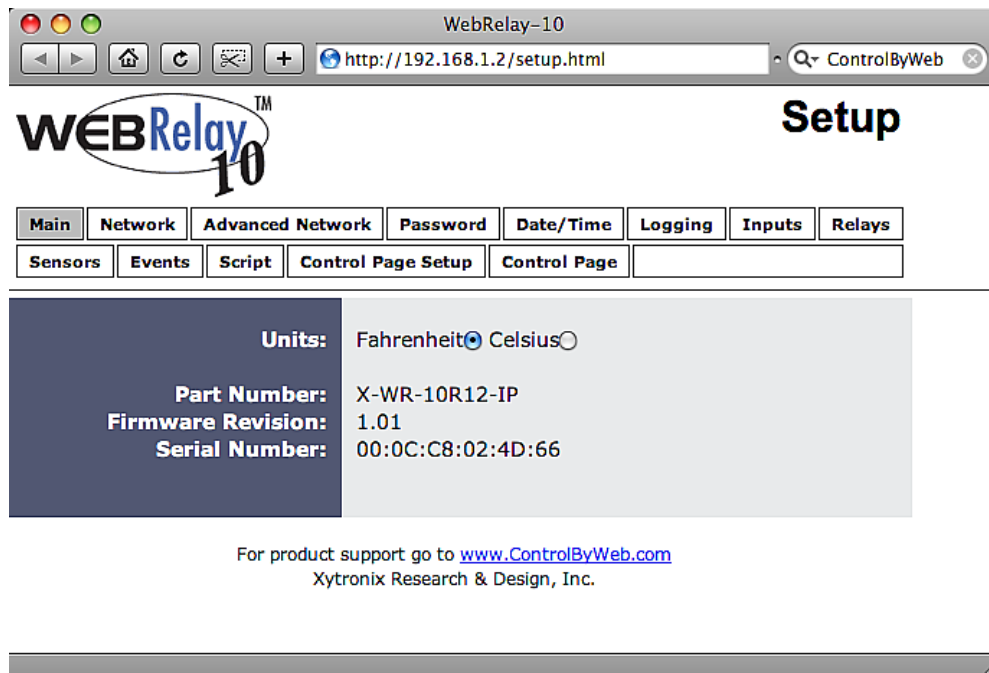

Figure 2.4a - Main Tab

Units (WebRelay-10 Plus™ only)

This allows the user to select between the temperature units of **Fahrenheit** and **Celsius**. All settings entered and displayed on subsequent pages will be in the units selected.

Part Number

This is the full model number of WebRelay-10.

Firmware Revision

This is the current product revision of the unit's firmware.

Serial Number

This is the serial number of this unit. The serial number is also the MAC address of the unit.

2.4.2 Network Tab

The network parameters are set on this page.

*Note: WebRelay-10 must be power-cycled (power disconnected, then reconnected) before network settings take effect. Only the settings on the **Network** tab require power-cycling before taking effect.*

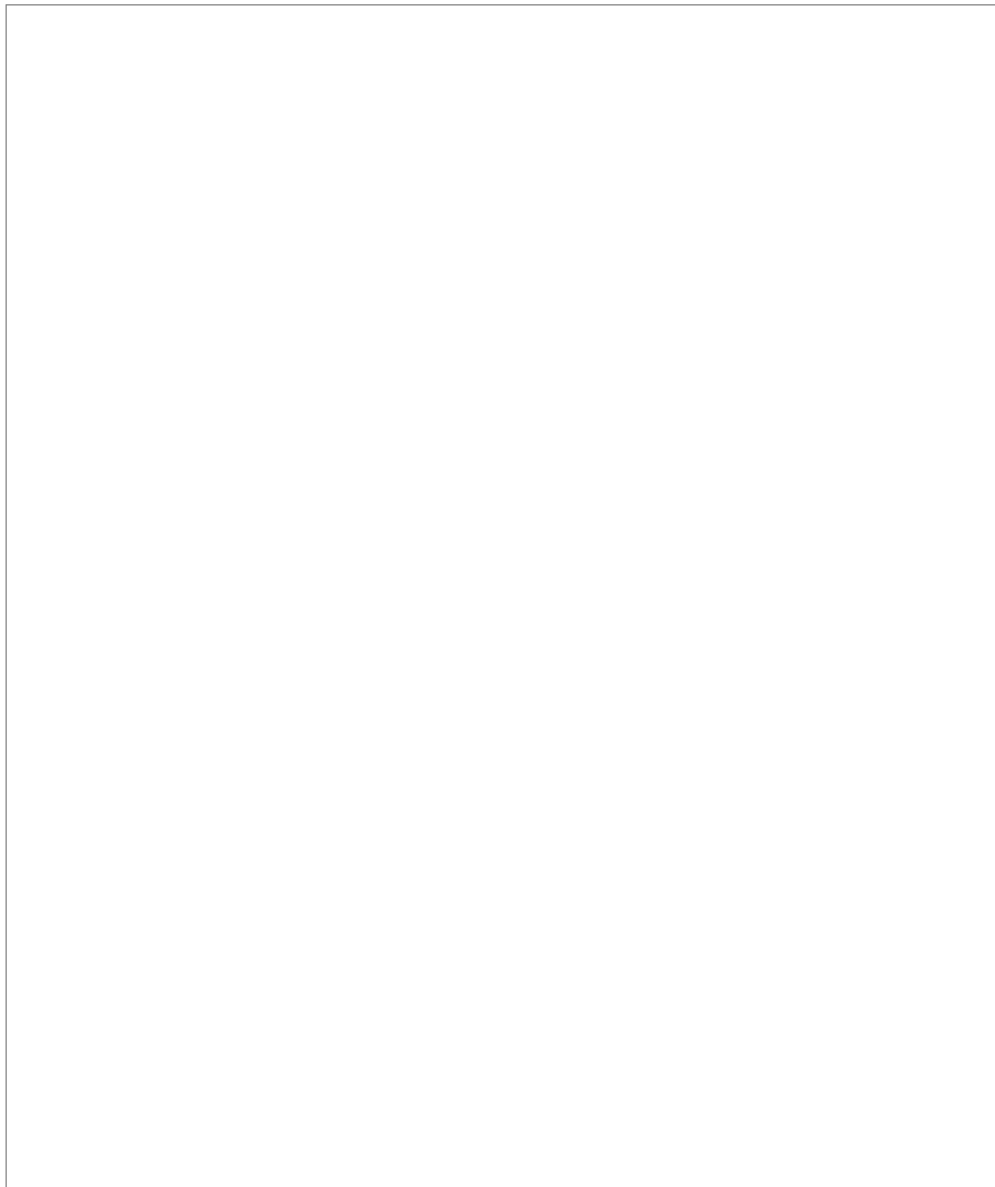

Figure 2.4b - Network Tab

Use DHCP (WebRelay-10 Plus™ only)

This option allows DHCP to be enabled or disabled. If this option is set to **Yes**, WebRelay-10 Plus™ will wait for an IP address from a DHCP server each time it is powered. The default setting is **No** (this is recommended for most installations). If DHCP is set to **Yes**, the Network page must be submitted and WebRelay-10 Plus™ must be rebooted before an IP address will be assigned. Once WebRelay-10 Plus™ is assigned an IP address by the DHCP, the new IP address can be found through the clients list kept by the DHCP server. For most instances, this is found on the local gateway or router.

Brief Notes About DHCP

All devices on an IP network require an IP address. This is a unique address that identifies each device on the network. DHCP (Dynamic Host Control Protocol) is a mechanism that automatically assigns an IP address to a computer (or other devices) when it is connected to a network. This eliminates the need to manually enter the IP address. When a computer is connected to the network, another device on the network called a DHCP server detects the presence of the computer and dynamically assigns the IP address to that computer. On many small networks, the DHCP server is built into the router.

DHCP works well for "client" devices such as computers, but is not ideal for servers. This is because servers usually don't initiate communications with other devices, but rather they wait for a request from "clients." To make this request, the client must know the IP address of the server. If a server gets its IP address dynamically, the IP address may not always be the same so client devices may not be able to find the server. For this reason, servers usually use an IP address that is fixed and does not change. The WebRelay-10 Plus™ is a server and manual IP address assignment is usually recommended.

IP Address

Enter the IP address for WebRelay-10 in this field. The IP address is specific to the network where WebRelay-10 will be installed, and must be obtained from the network administrator. For more information on IP addresses and remotely accessing WebRelay-10 over the Internet, see **Appendix C: Accessing WebRelay-10 Remotely Over the Internet**. The default setting for this field is 192.168.1.2.

Subnet Mask

The subnet mask defines the size of the local network. This must be obtained from the network administrator. For additional information about sub-netting and IP networking, many tutorials are available on the Internet. The default setting for this field is 255.255.255.0.

Gateway

This specifies the IP address of the gateway router. This must be obtained from the network administrator. The default setting for this field is 192.168.1.1.

Preferred DNS Server

The IP address of the Primary DNS server is specified here. When DNS services are required, this is the address that will be used. The default setting for this field is 192.168.1.1.

This field is only required when the following options are used:

- **Remote Services** (when server is specified by name and not IP address).
- **Sync time clock with remote NTP server** (when server name is specified by name and not IP address).
- **Mail Server** (when server name is specified by name and not IP address).

Alternate DNS Server

This field is used to specify the IP address of a Secondary DNS server. This is used when WebRelay-10 requires DNS services and the preferred DNS server is not available. The default setting for this field is 192.168.1.1.

HTTP Port

The TCP port used for HTTP communications (web browser, xml, get commands) with WebRelay-10 is specified here. The default setting for this field is 80, which is the standard HTTP port. It is recommended that the port be left unchanged unless the user has an understanding of TCP/IP and ports. For more information on TCP ports and IP addressing see **Appendix C: Accessing WebRelay-10 Remotely Over the Internet**.

Speed

This option sets the data rate (clock rate) of the Ethernet port. Either **10 Mbps** or **100 Mbps** can be selected. The **100 Mbps** option offers faster communications but the amount of data to and from WebRelay-10 is so small that users will not likely notice much (if any) difference. When the WebRelay-10 is set to **10 Mbps**, it draws less power and runs a little cooler, which may translate into a longer product life. The default setting for this field is **10 Mbps**.

IT IS RECOMMENDED THAT THIS SETTING BE LEFT AT **10Mbps** UNLESS THE USER HAS A SPECIFIC REASON TO USE **100Mbps**.

Mode

This option allows the Ethernet port to be set to **Half Duplex** or **Full Duplex**. Legacy Ethernet operates in **Half Duplex** mode which means that devices can either send data or receive data, but not both at the same time. **Full Duplex** means that devices can send and receive data at the same time. The default setting for this field is **Half Duplex**.

Mail Server (SMTP)

The name of the SMTP (Simple Mail Transfer Protocol) mail server (for example mail.example.com) or the IP address of the mail server (for example 192.10.10.10) should be entered in this field. There is no default setting for this field.

Note: If the server name is entered and not the IP address, the address of a DNS server will be required.

Mail Server Port

This field is used to specify the SMTP Mail Server Port. The default setting is 25, which is the standard SMTP port.

User Name (If Required)

If the SMTP mail server requires authentication, the user name must be entered here. There is no default setting for this field.

Password (If Required)

If the SMTP mail server requires authentication, the password must be entered here. There is no default setting for this field.

Return Email

WebRelay-10 will not receive email messages, but when WebRelay-10 sends email messages, it must include a return email address. This field is used to specify the return email address. Note that although WebRelay-10 will send email messages with any email address specified in this field, some email filters (spam filters) will not allow messages through that include an invalid email address. There is no default setting for this field.

Email 1 to Email 5

Enter the email addresses of up to five recipients for alarm messages in these fields. There are no default settings for these fields.

Email Length

Choose either "full" or "short" email lengths. When "full" is selected, all visible fields in the control page will be included in the email message to be sent out; however if "short" is selected, the email content will only be a brief description of what triggered the email message.

Remote Reboot

To cause the device to reboot, the following command can be entered into the address bar of the browser: <http://192.168.1.2/networkSetup.srv?rbt=1> The username and password will be requested before the reboot will occur, so that only administrators of the device can cause the reboot.

MTU Setting

To change the MTU, manually enter the advSetup.html (case sensitive) page into the address bar. (<http://192.168.1.2/advSetup.html>). This new setup page will have a text box that will allow the MTU to be changed. The valid range is 256 to 1476 bytes. MTU is a network parameter that stands for Maximum Transmission Unit. This defines the max size, in bytes, of the TCP packets sent out from the device. This normally can be left alone, but there are some circumstances where it might be beneficial to change it. One of these circumstances is when the device is to be used over a VPN (virtual private network). VPN's add extra information to TCP packets, if the new packets are too big to physically travel across the network (greater than about 1500 bytes) then the packets will be split up. This causes problems for some firewalls and those firewalls will just discard the packets. To fix this, the MTU can be adjusted until the TCP packets do not get split up.

2.4.3 Advanced Network Tab

Note: These settings are not used for most installations.

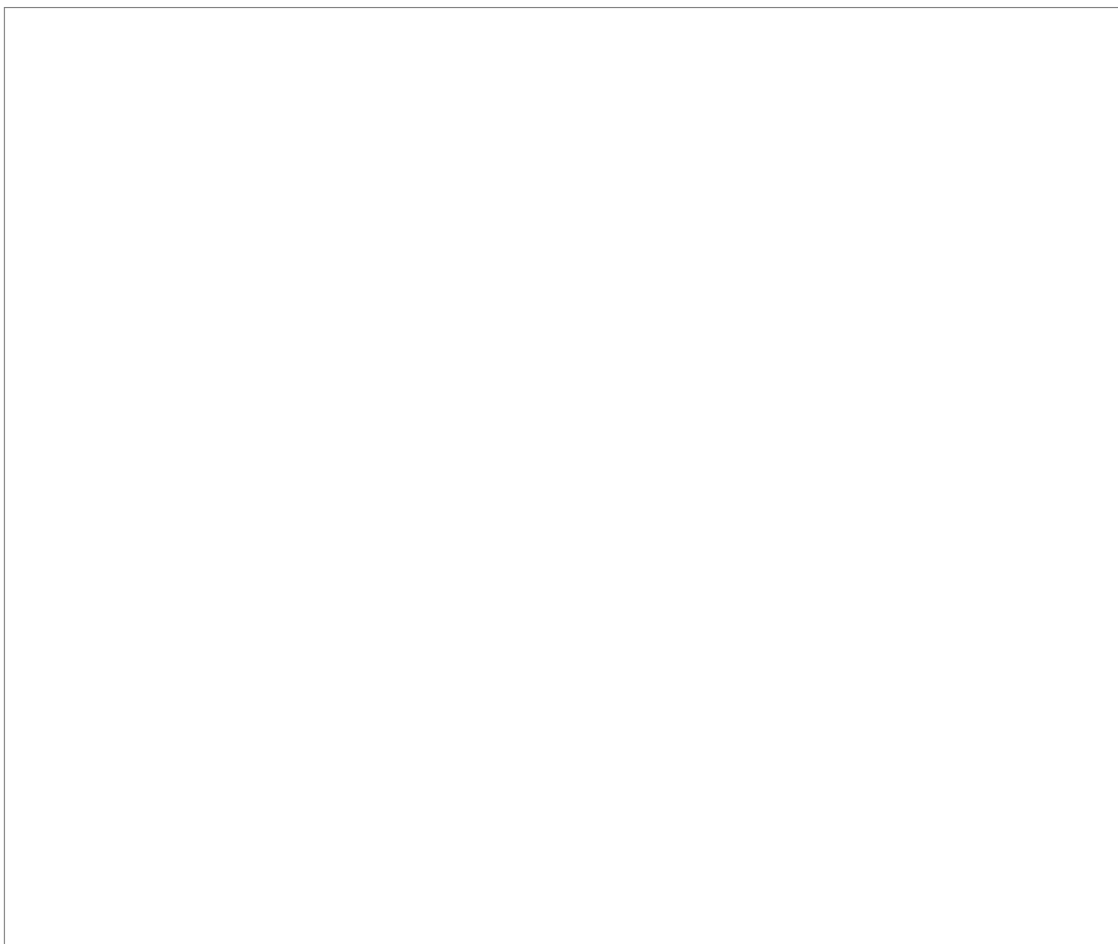

Figure 2.4c - Advanced Network Tab

Modbus Enabled

WebRelay-10 can support Modbus/TCP. Modbus is a messaging structure protocol used in industrial manufacturing control and automation. It is an open protocol and offers interoperability with software and devices from other manufacturers. This is enabled by selecting **Yes** in this field. The default setting for this field is **No**. (See **3.4 Modbus Operation** for more information on using WebRelay-10 on a Modbus network.)

Note: Modbus communications are disabled whenever the Control Password is enabled.

Modbus Port

This specifies the port used for Modbus/TCP communications with WebRelay-10. By default this is set to port 502 which is the standard Modbus port. It can be set within the range of 0 to 65535.

Remote Services Enabled

This option enables or disables Remote Services. If **Yes** is selected, Remote Services will be enabled as soon as the submit button is pressed and WebRelay-10 will immediately attempt to make a connection with the remote server (power cycle not required). Once a connection is established, the connection will remain until it is disconnected by the remote server. Proper connection with the remote server can be verified by viewing the system status log file (see **Appendix D: Log Files**). The default setting for this field is **No**. Most users should leave this setting at its default. (See **Remote Services** at the end of this section for more information.)

Server Name/IP Address

Specify the name or IP address of the Remote Services server here. If the IP address is specified, enter it in this format aaa.bbb.ccc.ddd. For numbers that are less than 100, preceding zeros should not be included (for example, enter 80 rather than 080). This field can be up to 40 characters long and has no default setting.

Server Port

Enter the TCP port used for the Remote Services server. This can be set within the range of 0-65535. The default setting for this field is 8000.

Connection String

This text is sent to the Remote Services server when the connection is established. This string should include any information required by the server at connection. For example, it may include an ID number, customer number, password, etc. The format is entirely dependent upon the server requirements. This field can be up to 80 characters long. Default text is provided only as an example placeholder. The default text is [`<serialAddress>`]:ControlByWeb,X-10.

Connection Interval

This field specifies the periodic interval in which WebRelay-10 attempts to connect to the remote server, or if WebRelay-10 is already connected, it is the interval in which WebRelay-10 sends the connection string. This field can be set within the range of 1 to 34452 minutes. The default setting for this field is 1 minute.

SNMP Enabled

When this option is set to **Yes**, WebRelay-10 will support SNMP. The default setting for this option is **No**. (See 2.4.3.2 SNMP for more information.)

SNMP Manager IP

When SNMP is used, this field is used to specify the IP address of the SNMP manager. The default setting for this field is 192.168.1.25.

SNMP Port

When SNMP is used, this field is used to specify the SNMP port that WebRelay-10 listens on. The default setting for this field is 161.

SNMP Trap Port

When SNMP is used, this field is used to specify the SNMP Trap port of the SNMP manager. The default setting for this field is 162.

IP Filter Range 1 and IP Filter Range 2

For additional security, WebRelay-10 has a simple built-in firewall. If desired, WebRelay-10 can be configured to only allow access to client devices (computers, servers, other ControlByWeb™ devices, etc) with certain IP addresses. Two IP address ranges are provided and only client devices with addresses that fall within those two ranges will be allowed access. Devices with IP addresses that fall outside of those ranges will not receive any response from WebRelay-10. The following are examples.

To allow access from any device (this is the default setting):

IP Filter Range 1:	0.0.0.0 255.255.255.255
IP Filter Range 2:	0.0.0.0 0.0.0.0

To limit access to only one device (address 192.168.1.33):

IP Filter Range 1:	192.168.1.33 192.168.1.33
IP Filter Range 2:	0.0.0.0 0.0.0.0

To limit access to only devices on the local network and one device on the internet (address 10.143.100.32):

IP Filter Range 1:	192.168.1.0 192.168.1.255
IP Filter Range 2:	10.143.100.32 10.143.100.32

Note: The address specified for the Remote Services server (if applicable) is automatically allowed through the firewall no matter how this is set.

Remote Services

Remote Services initiates an outgoing connection to a server at a remote location. This can be used in an environment where a web server on the Internet provides a custom web page to WebRelay-10 and other ControlByWeb products. Users access WebRelay-10 through the web server rather than communicating directly with it. This method is sometimes referred to as “web services” and allows programmers to create powerful, custom web pages to multiple devices using the web programming languages of their choice.

Remote Services initiates the connection to the external web server (rather than the web server initiating communications to WebRelay-10). This has two main benefits. First, the web server does not need to know the IP address of WebRelay-10. This means that WebRelay-10 can get its IP address dynamically from a DHCP server, simplifying the installation. Second, since the connection from WebRelay-10 is outgoing, rather than incoming, the local router on the network where WebRelay-10 resides doesn't need to be configured to forward sockets. This also simplifies the installation. Since the router configuration is not modified, the risk of compromising security on the local network is eliminated. For more information about the **Remote Services** see **Appendix E: External Server and Remote Services**.

SNMP

Simple Network Management Protocol (SNMP) is used to manage and administer network devices. WebRelay-10 supports SNMP V1.0 and can be configured here. Using SNMP, the input and relay states of WebRelay-10 can be read as well as some basic information about the device. See **Appendix F: SNMP Requests** for information about how to request information from WebRelay-10 using an SNMP manager, as well as where to find MIB files for WebRelay-10.

Note: The read and write community strings used for SNMP are actually the Control Password found on the Password setup tab (see Section 2.4.4). If the Control Password is disabled, then WebRelay-10 does not check for the community string when issued a Get or GetNext request from the SNMP manager.

2.4.4 Password Tab

WebRelay-10 requires a password to log into the setup pages. The password can be changed on this page. Additionally, the installer can enable the requirement for a **Control Page** password.



Figure 2.4d - Password Tab

Setup Password

The Setup Password, which is required to access the setup pages, can be modified by entering a new password here. Passwords that are 8 characters or longer (up to 13 characters can be entered in this field) with both alphabetic and numeric characters are recommended. For security purposes, the password will not be displayed as it is entered. Note that the username required for accessing the setup pages is `admin` (all lower case). The default Setup Password is `webrelay` (also all lower case).

Re-enter Setup Password

When the Setup Password is changed, it must be entered twice. One time in the previous field and a second time in this field. If the password is not entered identically in both fields, the password will not be changed.

Enable Control Password

The **Control Page** can be viewed without entering a password. For security purposes, a password can be required for access to the **Control Page**. When this field is set to **Yes**, a password will be required to view the **Control Page**. The default setting for this field is **No**.

Control Password

When the Enable Control Password option above is set to **Yes**, this field is used to specify the password which will be required to access the **Control Page**. Passwords that are 8 characters or longer with both alphabetic and numeric characters are recommended. For security purposes, the password will not be displayed as it is entered. Note that WebRelay-10 requires a password, but does not require a user name to access the **Control Page**. However, some browsers require that a user name be entered. In this instance enter none as the user name. The default Control Password is `webrelay`.

Re-enter Control Password

When the Control Password is changed, it must be entered twice. One time in the previous field, and

a second time in this field. If the password is not entered identically in both fields, the password will not be changed.

2.4.5 Date/Time Tab (WebRelay-10 Plus™ only)

WebRelay-10 Plus™ uses the time for scheduled events, such as turning the relays **ON** or **OFF** at scheduled times and for logging (a time stamp is included with each logged event). The time is stored and displayed in 24-hour time format. WebRelay-10 Plus™ has a capacitor-backed real-time-clock circuit that will keep track of time for several days in the event of a power failure.



Figure 2.4e - Date/Time Tab - Set Time Manually

Current Date/Time

This is the current date and time stored in WebRelay-10 Plus™. The time is stored and displayed in 24-hour format.

Set Time

This drop-down list offers two options for setting the time: **Manually** or **Sync with NTP server**. The options that follow this field will change based upon how this option is set.

- **Manually** requires the user to enter the time and date. When this option is selected, parameters 3-4 appear.
- **Sync with NTP server** allows the user to set the clock automatically by using an NTP (Network Time Protocol) server.

Manual Time Configuration

Date

The current date is entered by first selecting the correct month and year, using the left and right arrows at the top of the calendar. The single arrows (< and >) change the month and the double arrows (<< and >>) change the year. Once the current month and year are displayed, select the correct day, which will then be highlighted.

Time (24 Hour Format)

Enter the time as HH:MM:SS. (HH represents hours in 24-hour format [00-23], MM represents

minutes [00-59], SS represents seconds [00-59].)

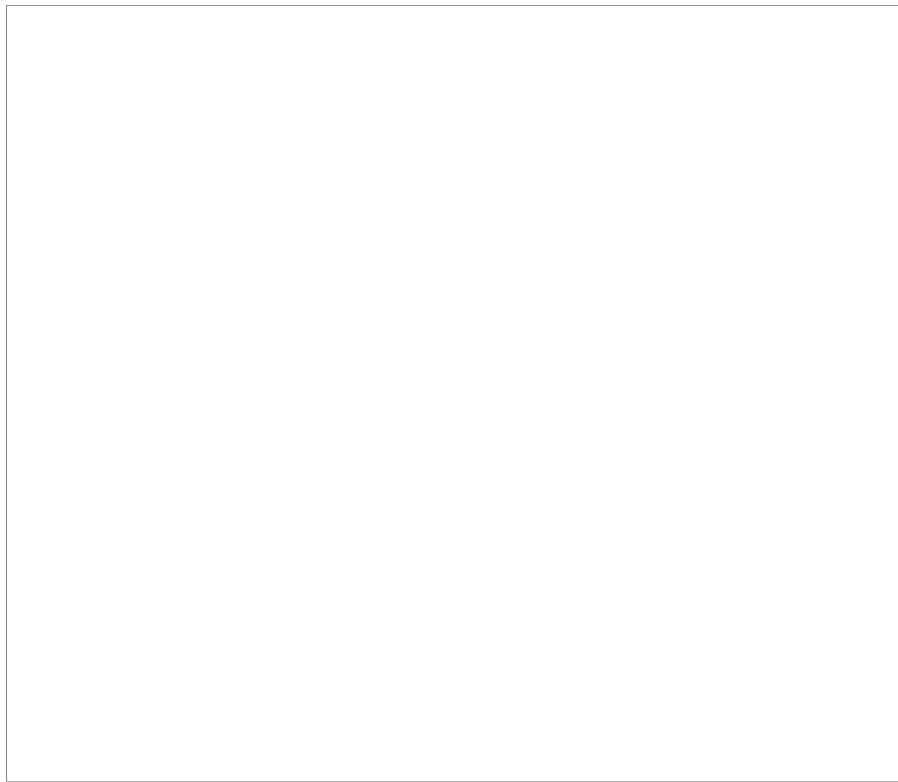

Figure 2.4f - Date/Time Tab - Sync with NTP Server

NTP Time Configuration

Server Name/IP Address

This field is used to specify the name or IP address of the NTP server. If a name is specified, a working DNS server address must be entered into the Network settings. If the IP address is specified, it should be entered in the following format aaa.bbb.ccc.ddd where each of the letters represents a number between 0 and 255. This field can be up to 40 characters. There is no default value for this field.

Many NTP Internet servers are available. In addition, many desktop computers will function as an NTP server (both Mac and PC). If a desktop computer is used, firewall settings may need to be adjusted to allow for NTP communications on port 123.

Public NTP servers can be found at www.pool.ntp.org. Some of these are listed below.

US Servers (<http://www.pool.ntp.org/zone/us>):

- 0.us.pool.ntp.org
- 1.us.pool.ntp.org
- 2.us.pool.ntp.org
- 3.us.pool.ntp.org

North America (<http://www.pool.ntp.org/zone/north-america>):

- 0.north-america.pool.ntp.org
- 1.north-america.pool.ntp.org
- 2.north-america.pool.ntp.org
- 3.north-america.pool.ntp.org

Europe (<http://www.pool.ntp.org/zone/europe>):

- 0.europe.pool.ntp.org
- 1.europe.pool.ntp.org

2.europe.pool.ntp.org
3.europe.pool.ntp.org

Australia (<http://www.pool.ntp.org/zone/au>):

0.au.pool.ntp.org
1.au.pool.ntp.org
2.au.pool.ntp.org
3.au.pool.ntp.org

South America (<http://www.pool.ntp.org/zone/south-america>):

0.south-america.pool.ntp.org
1.south-america.pool.ntp.org
2.south-america.pool.ntp.org
3.south-america.pool.ntp.org

Africa (<http://www.pool.ntp.org/zone/africa>):

1.africa.pool.ntp.org
1.pool.ntp.org
3.pool.ntp.org

Sync With Server

This option allows the user to specify how often WebRelay-10 Plus™ time will be synchronized with the time server. When the submit button on this page is pressed, WebRelay-10 Plus™ will immediately synchronize with the time server. If Daily, Weekly, or Monthly options are selected, WebRelay-10 Plus™ will thereafter re-synchronize with the time server at the period interval specified starting at 12:00 AM (00:00).

The exact time the NTP Request occurs is 12:00 AM (00:00) plus the minute equivalent of the last two digits in the models serial number. For example, if the last two digits in the model's serial number were -09, the NTP Request will occur 9 minutes after 12:00 AM. The default value of this setting is Once (the unit will immediately sync with the NTP server, but will not automatically sync again).

Sync on Power Up

When this option is set to **Yes**, WebRelay-10 Plus™ will be synchronized with the time server each time it is powered.

*Note: If WebRelay-10 Plus™ will lose power on a frequent basis, it may be beneficial to set this option to **No**; some servers are configured to dis-allow access from client devices that excessively request their services. The default value of this setting is **No**.*

UTC Offset

Time servers return the current time in Universal Time (GMT). It is common for many servers and data loggers to use GMT as their official time, even when they are not located within the GMT time zone. The default value for this field is -7 (Mountain Standard Time). For convenience, the time can be converted to local standard time by entering the offset here. This manual cannot include the UTC Offset for all parts of the world, but the offset for GMT time and the four major US Time zones are listed here.

GMT Time: 0
Eastern Standard Time: -5
Central Standard Time: -6
Mountain Standard Time: -7
Pacific Standard Time: -8

Daylight Savings

In many parts of the United States and in some other countries, the time is shifted forward by one hour during the summer months. This is an effort to conserve energy by making the daylight last longer into the evening hours. If this option is set to **Yes**, the time on WebRelay-10 Plus™ will automatically be shifted forward by one hour between the hours of 12:00 AM – 5:00 PM on the Daylight Savings Start date set below, and it will shift back to standard time between the hours of 12:00 AM – 5:00 PM on the Daylight Savings End date set below. The time change is made at a

random time within the previously mentioned, five-hour time frame, in order to prevent several different devices from simultaneously requesting a time and overwhelming the NTP server. The default setting is **Yes**.

Note: Enabling the daylight savings time adjustment, scheduled events will be adjusted for the new time. Logged data includes a time stamp based upon the current time in the device, so it is possible to duplicate log times in the spring and miss log times in the fall. To avoid confusion, many servers and data loggers are set to remain on GMT time and do not shift for daylight savings.

Daylight Savings Start

This is the date that daylight savings will start. Note that on this date, between the hours of 12:00 AM – 5:00 PM, the current time will be shifted forward by one hour (i.e. the time will jump from 12:02 AM [00:02] to 1:02 AM [01:02]). By default this is set to the 2nd Sunday in March which is the date used in the United States.

Daylight Savings End

This is the date that daylight savings will end. On this date, between the hours of 12:00 AM – 5:00 PM, the current time will be shifted backward by one hour (i.e. the time will jump from 12:02 AM [00:02] to 11:02 PM [23:02] the day before). By default this is set to the 1st Sunday in November which is the date used in the U.S.

2.4.6 Logging Tab (WebRelay-10 Plus™ only)

WebRelay-10 Plus™ can be configured to record data such as changes in relay and input state, sensor data, and events. Both periodic and event-based logging are supported. The logged data is stored in internal nonvolatile memory and can be retrieved by entering the command `http://{WebRelay-10 IP address}/log.txt`. For more information on logging, see **Appendix D: Log Files**.

Note: Changing the log settings will erase the current log file.

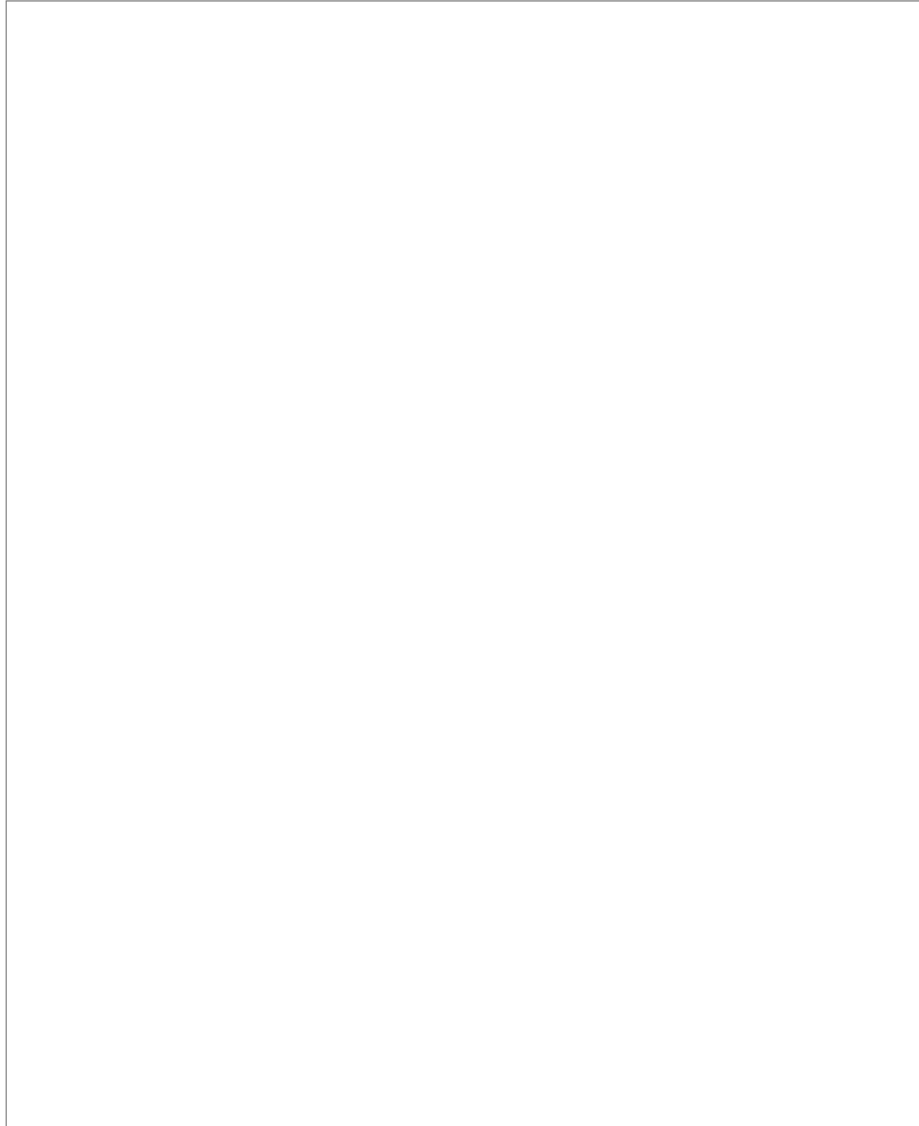

Figure 2.4g - Logging Tab

Logging Enabled

When this option is set to **Yes**, WebRelay-10 Plus™ will record data as configured on this page. The default setting for this option is **No**.

Note: This option controls data logging, but not system logging. System logging is always enabled.

Start Time

If a logging interval is specified (periodic logging rather than event logging), logging will occur relative to this start time. For example, if the start time is 01:00 and the logging rate is 6 hours, logging will occur at 01:00, 07:00, 13:00, and 19:00. Start time is specified in 24-hour time format.

The default setting for this field is 01:00.

Logging Rate

This field is used to specify the time period of logging. A numerical value is entered into the text field, and the unit of time is selected using the adjacent radio buttons. The range of values in this field is 1-20864. Time units are **Minutes**, **Hours**, and **Days**. Periodic logging can be disabled by selecting the Event Logging Only radio button.

Sensor Trigger Delta

WebRelay-10 Plus™ can be configured to log data when the temperature/humidity measured by a sensor changes by the amount specified in this field. This can be set from 1.0 to 24.0 degrees in 0.1 increments. The default setting for this field is 2.0 degrees.

Logging Configuration

This table is used to select which relays, inputs, and sensors get logged and which events trigger the logging. The first column in the table identifies the relays, inputs, sensors, etc. that can be logged or cause logging events. The second column is used to specify what gets logged. The third column is used to specify which events can cause a log entry to be created.

When relays are selected as an **Event Trigger**, logging will occur whenever the selected relay is turned **ON** or **OFF**. When inputs are selected as an **Event Trigger**, logging will occur whenever the input state changes. When sensors are selected as an **Event Trigger**, logging will occur whenever the temperature/humidity changes by a set amount.

The following **Log/Event Trigger** options are available:

- Input (1 - 2)
- Relay (1 - 10)
- Sensor (1 - 8)
- Events
- XML Requests
- MODBUS Requests
- SNMP Requests

Filter Logged Requests

When logging is enabled for XML Requests, Modbus Requests, or SNMP Requests, the user can filter out **Reads** (such as reading the relay or input state via an XML request) or **Writes** (such as changing the relay state via an XML command).

On the **Control Page Setup** tab, the user can specify the refresh rate of the Control Page. Each time the page is refreshed, an XML request is sent and logged as a Read. Since the default refresh rate is 3 seconds, the log file can get cluttered by many XML request logs. By filtering out **Reads**, refresh requests will not be shown in the log. Likewise, by selecting **Writes**, any log created by changing the state of the relay will not be shown in the log file. The default selection is **None**.

Note: When XML Requests are setup to be logged, the IP address from which the Read or Write is generated is logged, as well as if it was a Read request (R) or Write request (W). See Appendix D: Log Files for additional information.

Next Log Time

This field displays the next periodic log time. If logging is disabled, the next log time will indicate "Disabled." If logging is enabled, but periodic logging is disabled (by selecting **Event Logging Only**) the next log time will indicate "Event Logging Only."

Note: This information is updated only when the page is refreshed.

2.4.7 Inputs Tab (WebRelay-10 Plus™ only)

This page provides configuration options for the two control inputs built into WebRelay-10 Plus™.



Figure 2.4h - Inputs Tab

*Note: In this manual, the input is considered to be **ON** when the input is tied to ground.*

Input

This drop down menu is used to select the control input to which the options below will apply.

- **Input 1** or **Input 2**: Selects the corresponding control input.

Description

This text field is used to describe the function of the selected input. The text appears to the left of the corresponding input status on the **Control Page**, and in email messages when email alerts are enabled. This field may be up to 24 characters long. The default text is Input #.

On Status Text

The text in this field specifies the text that will be displayed in the **Control Page** and in email messages when the input is **ON** (input tied to ground). Up to 14 characters may be entered in this field. The default text is ON.

Off Status Text

The text in this field specifies the text that will be displayed in the control page and in email messages when the input is **OFF** (input is open). Up to 145 characters may be entered in this field. The default text is OFF.

Counter Options

The inputs can be used as counters. This field specifies counter operation.

*Note: The input voltage must remain **ON** or **OFF** for the minimum hold time before the counter will be incremented, see **Appendix H: Specifications**.*

- **counter off**: The counter is deactivated and will not be incremented
- **increment when input on**: Each time the input is tied to ground, the counter will increment.
- **increment when input off**: Each time the input is open, the counter will increment.
- **increment when input changes**: Each time the input is open or tied to ground the counter will increment

Reset Count

The counter will reset to 0 as soon as the count reaches the value specified in this field. The counter is reset immediately when it reaches this value so this value will never be returned when the counter is read. For example, if the 'Reset Count' is set to 10, the counter will count from 0 to 9 and return to 0 on the next count. This value can be set from 1 to 4000000000.

Email Option

Simple email messages can be sent in response to input changes. This parameter is used to specify what input changes, if any, will cause email messages to be sent. Note that email notification will work only if the email settings are correctly set up in the **Network** setup page. The following options are available:

- **No Email Messages**: No email notifications will be sent due to input changes.
- **Send Email when input on**: Email notifications will be sent when input state changes to On.
- **Send Email when input off**: Email notifications will be sent when input state changes to **OFF**.
- **Send Email when input changes state**: Email notifications will be sent when input changes state to **ON** or **OFF**.

*Note: The default setting for this field is **No Email Messages**.*

Use Email Address

If email messages are to be sent out based on input changes, these check boxes specify to which email addresses the message will be sent. Email addresses specified on the **Network** setup tab will be displayed next to each check box. By default, no boxes are checked.

Remote Service/SNMP

When this box (Send State Msg/Trap on Input Change) is checked, SNMP traps and/or State messages will be sent whenever the input state changes. Remote Services or SNMP must be enabled and properly configured for this feature to be effective.

2.4.8 Relays Tab

This page provides configuration options for the ten relays.

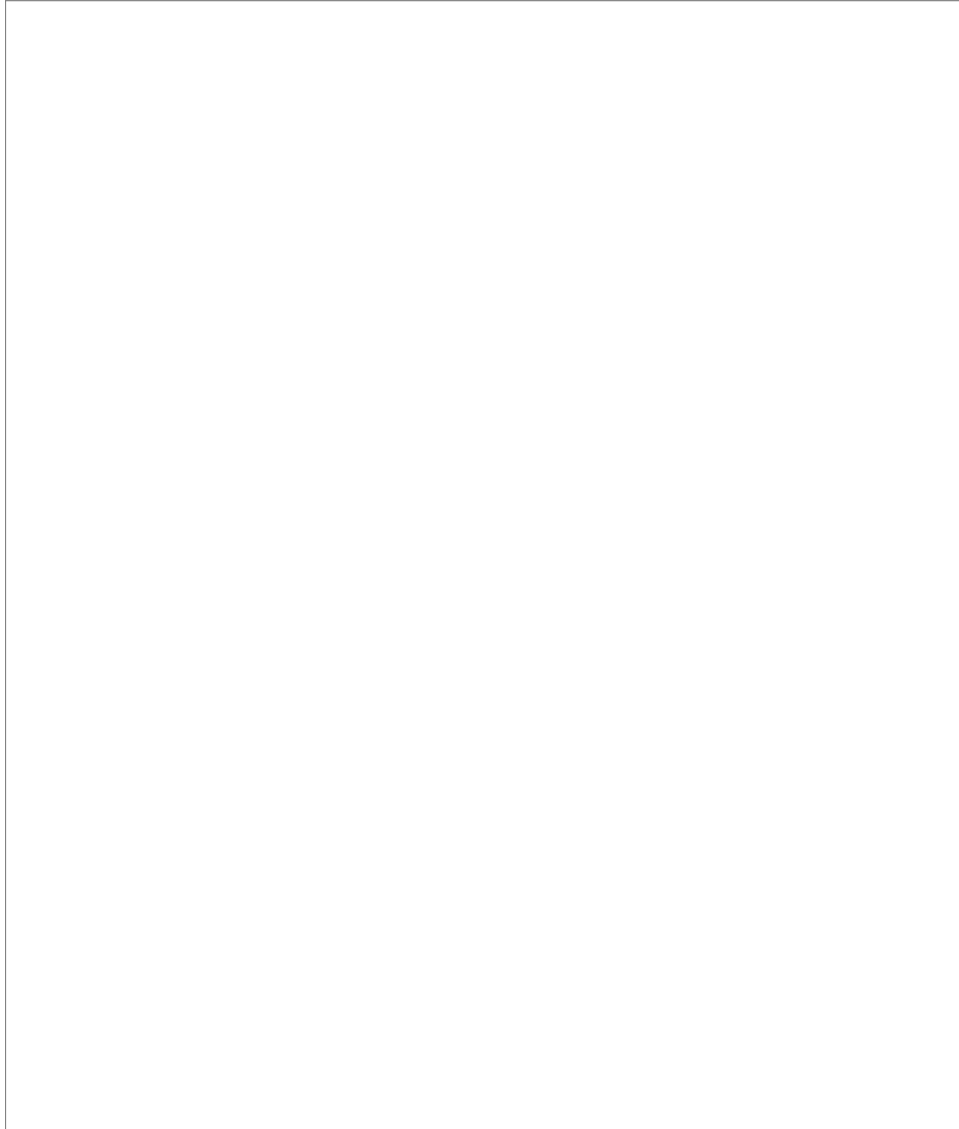

Figure 2.4i - Relays Tab

Relay

This drop down menu is used to select the relay for which the options below will apply.

- **Relay 1** to **Relay 10**: Selects the relay.

Relay Description

This text field is used to describe the function of the selected relay. The text appears to the left of the corresponding relay status on the **Control Page** and in the email message when email alerts are enabled. Up to 14 characters may be entered in this field. The default text is Relay #.

On Button Label

The text entered in this field appears in the 'On' button for the corresponding relay on the **Control Page**. Up to 10 characters may be entered in this field. The default text is ON.

Off Button Label

The text entered in this field appears in the **OFF** button for the corresponding relay on the **Control Page**. Up to 10 characters may be entered in this field. The default text is `OFF`.

Pulse Button Label

The text entered in this field appears in the 'Pulse' button for the corresponding relay on the **Control Page**. Up to 10 characters may be entered in this field. The default text is `PULSE`.

On Status Text

The text in this field specifies the text that will be displayed in the status field in the **Control Page** and in email messages when the corresponding relay is on. Up to 10 characters may be entered in this field. The default text is `ON`.

Off Status Text

The text in this field specifies the text that will be displayed in the status field in the **Control Page** and in email messages when the corresponding relay switches **OFF**. Up to 10 characters may be entered in this field. The default text is `OFF`.

Pulse Duration

When WebRelay-10 receives a pulse command for the relay, the relay will switch **ON** for the time specified in this field. The time is specified in seconds and can range from 0.1 seconds to 86400 seconds in 0.1 second increments. The default time is 1.5 seconds.

Note: When a pulse command is sent through the command interface, the command can include a pulse time, which will over-ride this value (for that pulse only).

Relay State at Powerup

This drop down menu lets the user specify the state of each of the internal relays when WebRelay-10 is powered up. The following options can be selected:

- **off (unless overridden by event)**: The relay will be **OFF** upon power up. This is the default setting.
- **on (unless overridden by event)**: The relay will be **ON** when power is applied to WebRelay-10.
- **last state (unless overridden by event)** (WebRelay-10 Plus™ only): Upon power up, the relay will return to its last state when WebRelay-10 Plus™ was powered off.
- **input state (unless overridden by event)** (WebRelay-10 Plus™ only): The relay will turn **ON** upon power up if the input is on.
- **opposite input state (unless overridden by event)** (WebRelay-10 Plus™ only): The relay will turn **ON** upon power up if the input is **OFF**, or be **OFF** if the input is **ON**.

Relay Option (WebRelay-10 Plus™ only)

The inputs can be configured to control the relay. The options in this drop down menu specify how the input affects the relay.

*Note: Input states will only affect the relay at the time the input is changed. Once the change has taken place the state of the input has no effect on the state of the relay. In other words, if the input causes the relay to go on, a user may turn the relay **OFF** from the web browser, even if the input is still **ON**.*

- **no relay control**: The input has no effect on the relay.
- **set relay equal input 1**: When the input is tied to ground, the relay turns **ON**. When the input is open, the relay turns **OFF**.
- **set relay opposite of input 1**: When the input is tied to ground, the relay turns **OFF**. When the input is open, the relay turns **ON**.
- **latch relay when input 1 on (reset via web)**: When the input is tied to ground, the relay turns **ON**. Once the relay is on, it will stay **ON** (unaffected by input change) until it is turned **OFF** manually via the web (or command) by a user or WebRelay-10 Plus™ is powered off. This option is useful for alarming functions.
- **latch relay when input 1 off (reset via web)**: When the input is open, the relay turns **ON**. Once the relay is **ON**, it will stay **ON** (unaffected by input change) until it is turned **OFF** through a computer command, **Control Page**, or WebRelay-10 Plus™ is powered off. This option is useful for alarming functions.

- ***latch relay when input 1 changes (reset via web)***: Each time the input is tied to ground or when the input is open, the relay turns **ON**. Once the relay is on, it will stay **ON** (unaffected by input change) until it is turned **OFF** via the web (or command) by a user or WebRelay-10 Plus™ is powered off. This option is useful for alarming functions.
- ***toggle relay when input 1 on***: When the input is tied to ground, the relay will change states. When the input is open, the relay will remain in its current state.
- ***toggle relay when input 1 off***: When the input is open, the relay will change states. When the input is tied to ground, the relay will remain in its current state.
- ***toggle relay when input 1 changes***: Each time the input is tied to ground or open, the relay will change states.
- ***pulse relay when input 1 on***: When the input is tied to ground, the relay will pulse for the Pulse Duration specified. The input may stay tied to ground and the pulse time will not be affected. If the input is tied to ground, opened, and then tied to ground again, before the end of the pulse time, the Pulse Duration timer will be restarted (it will re-start each time the input is tied to ground) and the relay will continue to remain **ON** until the timer expires.
- ***pulse relay when input 1 off***: When the input is open, the relay will pulse for the Pulse Duration specified. The input can remain open and the pulse time will not be affected. If the input is tied to ground and re-opened before the end of the pulse time, the Pulse Duration timer will be re-started (it will re-start each time the input is open) and the relay will continue to remain **ON** until the timer expires.
- ***pulse relay when input 1 changes***: Each time the input is tied to ground or opened, the relay will pulse for the Pulse Duration specified. If the state of the input changes before the end of the pulse, the timer will be re-started (it will re-start each time the input changes) and the relay will continue to remain **ON** until the timer expires.

Control Input (WebRelay-10 Plus™ only)

Selects which input will control the relay

- ***Input 1*** or ***Input 2***

Email Option

Simple email messages can be sent when relays are turned **ON** or **OFF**. This parameter is used to specify what conditions, if any, will cause email messages to be sent. Note that email notification will work only if the email settings are correctly set up in the **Network** setup page. The following options are available:

- ***No Email Messages***: No email notifications will be sent when relay changes.
- ***Send Email when relay on***: Email notifications will be sent when relay state changes to **ON**.
- ***Send Email when relay off***: Email notifications will be sent when relay state changes to **OFF**.
- ***Send Email when relay changes state***: Email notifications will be sent when relay changes state to **ON** or **OFF**.

*Note: The default setting for this field is **No Email Messages**.*

Use Email Address

If email messages are to be sent out when relays change state, these check boxes specify to which email addresses the message will be sent. Email addresses specified on the **Network** setup tab will be displayed next to each check box. By default, no boxes are checked.

Remote Service/SNMP

When this box (Send State Msg/Trap on Input Change) is checked, SNMP traps and/or State messages will be sent whenever the relay state changes. Remote Services or SNMP must be enabled and properly configured for this feature to be effective.

2.4.9 Sensor Tab (WebRelay-10 Plus™ only)

This tab is used to configure temperature/humidity sensors and associated alarms. WebRelay-10 Plus™ will automatically detect whether a temperature or humidity sensor is connected.

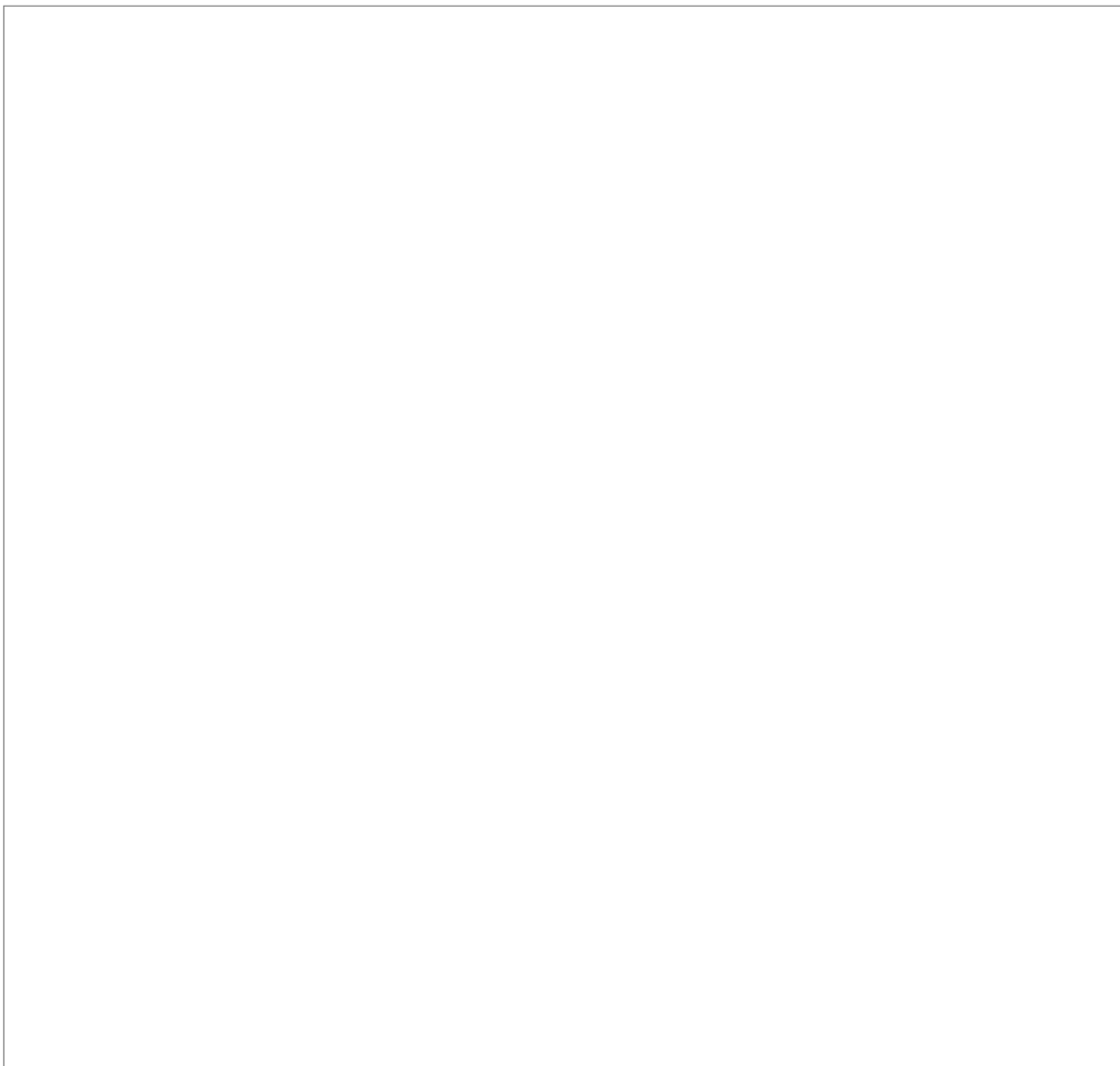

Figure 2.4j - Sensors Tab

Sensor

Up to eight sensors can be connected to WebRelay-10 Plus™. This drop-down list selects the sensor to be configured. The fields below are the same for each sensor.

Sensor Description

The text in this field appears to the left of the corresponding temperature/humidity reading on the Control Page. This text also appears in the email status message when email is enabled. This field can be up to 24 characters in length. The default text in this field is Sensor #.

Sensor Address

Each sensor connected to WebRelay-10 Plus™ should be associated (or assigned) to a sensor number. This identifies the name, location, and function of the sensor. Every temperature/humidity sensor comes from the factory with a unique, non-changeable address. When the sensors tab is selected (or the Refresh List button is pressed), WebRelay-10 Plus™ scans the bus for sensors.

The addresses of the sensors that are found on the bus are listed in the drop-down list. For each sensor number (Sensor 1... Sensor 8), select the address of the appropriate sensor from the drop-down list.

Selecting sensors is simplest when the sensors are connected to the bus one at a time. The procedure is to start with one sensor and associate it with the appropriate sensor number by selecting the sensor address within the appropriate drop-down list. Submit the page, connect a second sensor, and press the Refresh List button. Associate the second sensor to the appropriate sensor number. Continue this procedure until all sensors are set up.

Alarm 1

This setting is used to set the trigger point for an alarm condition. The number field specifies the temperature/humidity at which the alarm is triggered. The “High” and “Low” radio buttons indicate whether the alarm is triggered as a high or low alarm. A high alarm is triggered when the sensor reading exceeds the alarm value, and a low alarm is occurs when the sensor reading falls below the alarm value.

Alarm 2

This is a second alarm trigger that works similar to Alarm 1.

Deadband

This option sets the deadband used when evaluating alarm conditions. Deadband prevents alarms from triggering excessively when the sensor measurement vacillates quickly around the set point due to normal fluctuations. Deadband on high alarms requires the measurement to fall below the high alarm point minus the deadband before the high alarm can be triggered again. Likewise the deadband on the lower alarm requires the measurement to rise above the low alarm point plus the deadband before the low alarm can be triggered again. For example, if the deadband is set to 1 degree, and a high alarm is to occur at 95 degrees, the dead band ensures that once the high alarm is triggered, it won't go off until the temperature returns below 94 degrees ($95 - 1$). This reduces problems with small fluctuations in sensor readings triggering multiple alarms.

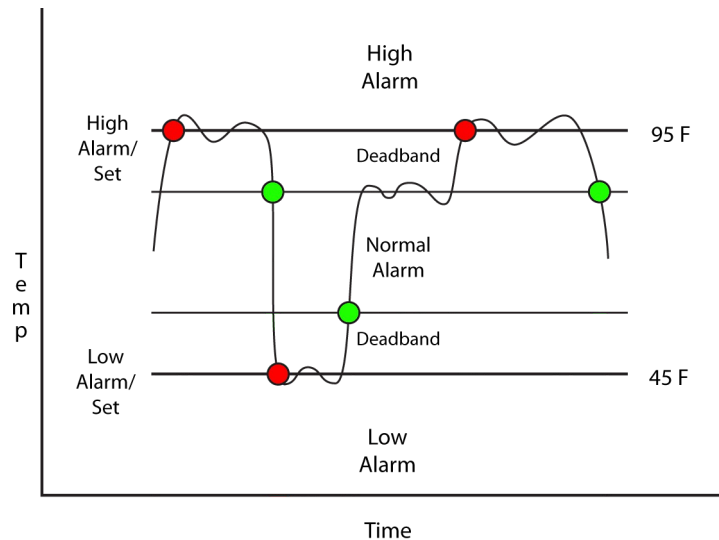

Figure 2.4k - Alarm Deadband

Email Option

Simple email messages can be sent in response to alarm conditions. This parameter is used to specify what alarm conditions, if any, will cause email messages to be sent. Note that email notification will work only if email is correctly setup in the **Network** setup page.

- **No Email Messages:** No email messages will be sent due to alarm conditions.
- **Send Email on Alarm 1:** Email notifications will be sent due to Alarm 1 conditions.
- **Send Email on Alarm 2:** Email notifications will be sent due to Alarm 2 conditions.
- **Send Email on Alarm 1 and Alarm 2:** Email notifications will be sent due to Alarm 1 or Alarm 2 conditions.

- **Send Email on Alarm 1, Alarm 2, and Normal:** Email notifications will be sent due to Alarm 1, Alarm 2, or when normal conditions are regained.

Use Email Address

If email messages are to be sent out based on alarm conditions, these check boxes specify to which email addresses the message will be sent. Email address specified on the **Network** setup tab will be shown next to each check box.

Remote Service/SNMP

This field specifies the action with a remote server due to an alarm condition.

- **No Action:** No action is taken.
- **Send State Msg/Trap:** An event string will be sent to the remote server.

For more information regarding the event string or other commands, see **Appendix E: External Server and Remote Services**.

The second drop down box specifies the conditions that will cause an alarm trigger. The following alarm conditions are available:

- **Alarm 1:** The specified action occurs due to Alarm 1.
- **Alarm 2:** The specified action occurs due to Alarm 2.
- **Alarm 1 or Alarm 2:** The specified action occurs due to Alarm 1 or Alarm 2.

2.4.10 Events Scheduler Tab (WebRelay-10 Plus™ only)

Events can be programmed to turn the relays **ON** and **OFF** at specific times. Up to 100 events can be created. Each event can occur one time or multiple times.

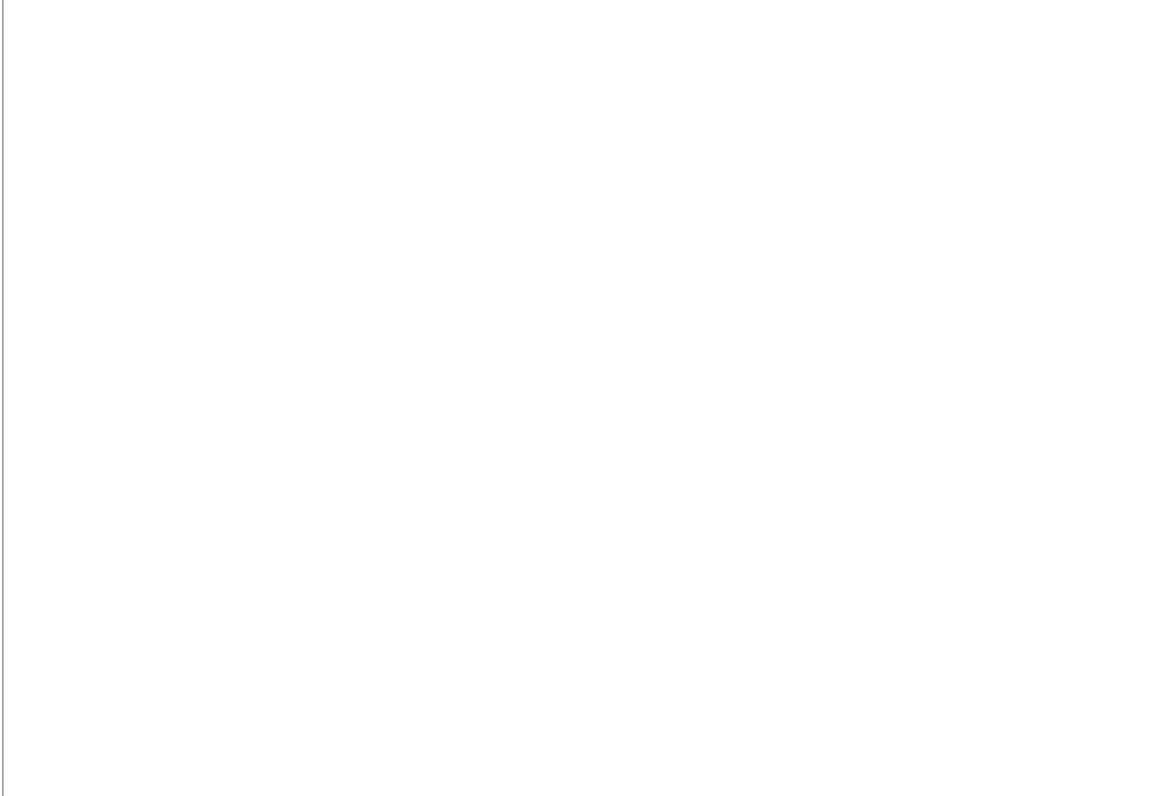

Figure 2.41 - Events Tab

A list of all scheduled events and information about each event is displayed in a table. Events can be sorted according to each column, in ascending or descending order. The following columns are displayed.

- **Events Scheduler: On/Off:** Turns scheduled events **ON** or **OFF**. **ON** is selected by default.
- **Current Date/Time:** Displays the current date and time.
- **Event #:** The number and name of events that are listed.
- **Schd #:** The schedule where the event is located (0 is the default schedule).
- **Start Date/Time:** The start date and time (24-hour) of the event.
- **Period:** The time between the start of successive events.
- **Count:** The number of times the event will occur.
- **Action:** What action the relays or schedule will take
- **Act #(s):** Which of the relays or schedules, if any, will be affected by the event.
- **Pulse:** If a relay pulse event is programmed, the Pulse Duration will be displayed.
- **Next Occurrence:** The date and time of the event's next occurrence will be displayed. If the event has already occurred, the event will be listed as "Inactive" here.

The events are color coded to indicate their status.

- **Gray** – Event has not been set up.
- **Green** – Events are active and will occur sometime in the future.
- **Red** – Events have been temporarily disabled by the disable event action.
- **Yellow** – Events have already occurred and are not scheduled to happen in the future.

Configuration of events is accomplished by clicking on the appropriate event, which causes the following setup screen to be displayed.



Figure 2.4m - Event Setup

Current Date/Time

This field displays the current date and time as specified in the **Date/Time** tab.

Schedule #

WebRelay-10 Plus™ can be setup to use multiple schedules. The master event schedule is schedule 0. (See **Schedules** at the end of this section for more information.)

Description

Text entered here is used to name and describe each event. The default text is `Event Description`.

Start Date

This field is used to enter the start date of the event. The date is entered by first selecting the correct month and year by using the left and right arrows at the top of the calendar. The single arrows (< and >) change the month and the double arrows (<< and >>) change the year. Once the current month and year are displayed, the date should be entered by selecting the day.

Start Time (HH:MM:SS)

The start time of the event is entered in the drop down menus as HH:MM:SS (HH represents hours in 24-hour format [00-23], MM represents minutes [00-59], SS represents seconds [00-59]). Default setting is 00:00:00.

Period

When events are configured to occur more than one time (any entry other than 1 in the Count below), the period field specifies the time between the beginning of events. This time can be specified in **Seconds**, **Minutes**, **Hours**, **Days**, or **Weeks** by selecting the appropriate option in the drop down menu. Default settings is 0 Days. Note that selecting 0 will disable the event.

Days

When a **Period** of one day is selected, the day (or days) on which that event will occur can be

specified by marking the appropriate check boxes.

Count

The number of times the event will occur is specified. The default text is 0. Note that entering 0 in this field will cause the event to occur continuously.

Action

This drop down menu specifies which action will take place when the event occurs. The following options may be selected

- **no action**: When this option is selected, nothing will happen when event occurs.
- **turn relay(s) on**: This option causes the relay(s) specified in the Affected Relay(s) field to turn **ON** (coil energized) when event occurs.
- **turn relay(s) off**: This option causes the relay(s) specified in the Affected Relay(s) field to turn **OFF** (coil de-energized) when event occurs.
- **pulse relay(s)**: This option causes the relay(s) specified in the Affected Relay(s) field to turn **ON** (coil energized) when the event occurs, and then turn **OFF** (coil de-energized) after the Pulse Duration time (specified below) expires.
- **toggle relay(s)**: This option causes the relay(s) specified in the Affected Relay(s) field to change states.
- **change schedules**: This option causes the schedule(s) specified in the Affected field to be enabled or disabled. See section **Schedules** at the end of this section for more information.
- **set extVar0**: External variables provide a way for scripts written in BASIC to interact with users, and for scripts to execute as a result of event occurrences. This option sets the variable extvar0 to 1 when the event occurs. If a running script uses this variable, it will function as defined in the script when the variable is set to 1.
- **clear extVar0**: This option clears extvar0 (sets it to 0) when the event occurs. See description of set extVar for more information.

Affected Relay(s)

When an Action is selected, the **Affected Relay(s)** on which that action will occur can be specified by marking the appropriate check boxes. When change schedules is selected, only check boxes 1-4 are selectable.

Pulse Duration

If the Relay Action has been set to **pulse relay(s)**, the **Pulse Duration** is set in this field. The time is specified in seconds and can range from 0.1 seconds to 86400 seconds in 0.1 second increments. The default time is 1.5 seconds.

Schedules

Events can be assigned to one of five schedules. The schedules are useful for creating complex events that vary with calendar dates, such as work shift alarms.

Schedule 0 is always active, it cannot be disabled. Other schedules can be enabled and disabled by schedule events. Multiple schedules may be active at one time. The following is an example of how schedules and events might be used.

Schedule 0 Event – Security system is enabled daily at 8 pm and disabled at 6 am, Monday through Friday. (The web interface could be used to disable the system for any authorized exceptions.)

Field Name	Event 1	Event 2	Application Description
Schedule #	0	0	Schedule 0 cannot be disabled by other events.
Description	Security ON	Security OFF	User description of event.
Start Date	Current Day	Current Day	Set to current or previous day.
Start Time	20:00:00	06:00:00	Start time in 24 hr format.
Period	1 Days	1 Days	Event occurs daily.
Days	M-F	M-F	Security system is disabled during work hours and remains on over weekend.
Count	0	0	Event is always in effect, set to zero.
Action	turn relay on	turn relay off	Security system is controlled through a Relay 1.
Affected	1	1	
Pulse Duration	n/a	n/a	The value is ignored except for a pulse action.

Schedule 1 and 2 Events – Shift alarm sounds at 8 am and 5 pm Monday through Friday, during winter months but, shifts to 6 am start time during summer.

Field Name	Event 3	Event 4	Event 5	Event 6	Event 7	Event 8
Schedule #	1	1	1	2	2	2
Description	Summer AM Bell	Summer AM Bell	End Summer	Winter AM Bell	Winter AM Bell	End Winter
Start Date	30 May	30 May	01 Sep	01 Sep	1 Sep	30 May
Start Time	08:00:00	17:00:00	00:00:00	06:00:00	03:00:00	00:00:00
Period	1 Days	1 Days	1 Days	1 Days	1 Days	1 Days
Days	M-F	M-F	All	M-F	M-F	All
Count	0	0	0	0	0	0
Action	pulse relay	pulse relay	change schedules	pulse relay	pulse relay	change schedules
Affected	2	2	2	2	2	1
Pulse Duration	3	3	n/a	3	3	n/a

In the above example, the Affected row applies to relays when a relay action is selected, or schedules when a change schedule action is selected.

The security system example could also be changed to schedules 1 and 2, allowing for different hours of operation for summer and winter schedules. Additional lunch or break bells could also be added to schedules 1 and 2 or added in schedules 3 and 4. Events 5 and 8 would also enable and disable schedules 1, 2, 3, and 4.

Additional equipment could be controlled by event schedules such as lighting, compressors, and magnetic door locks.

2.4.11 Script Tab

WebRelay-10 can be used to run simple custom programs written in a language similar to BASIC. This page is used to load and execute these programs. Before it can be loaded to WebRelay-10, a script must first be written as a .txt file. The file must then be uploaded to WebRelay-10. The maximum size of script that can be uploaded to the device is 2K bytes. Information on writing a basic program for WebRelay-10 can be found in **Appendix G: Basic Scripts**.

Note: An ASCII standard text file format should be used, such as Windows Notepad, Programmer's Notepad, vi, or other text editor that output the file as a .txt. Rich Text Format (.rtf) used by Microsoft WordPad is NOT compatible.

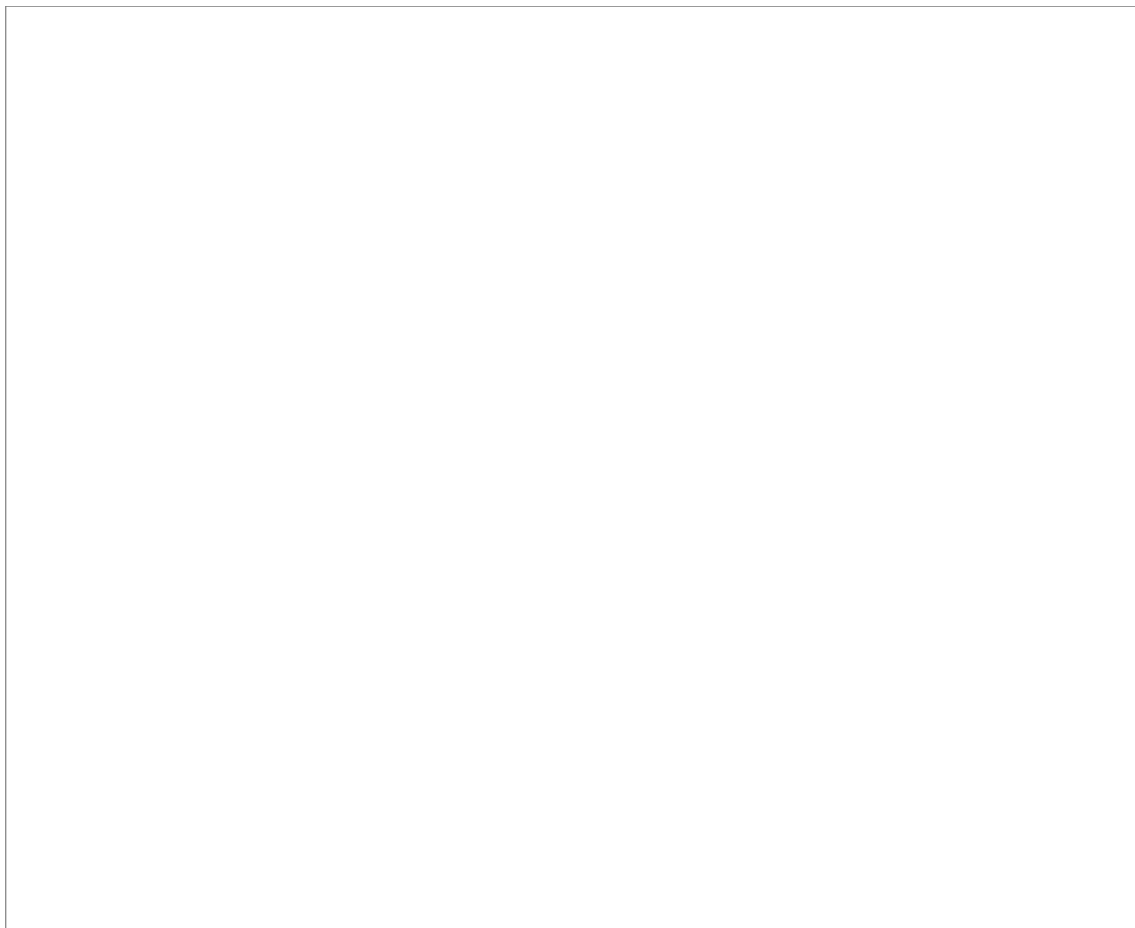

Figure 2.4n - Script Tab

BASIC Script

This field displays the .txt file that is uploaded to WebRelay-10. Text displayed in this screen cannot be edited. In order to edit any script, it must be rewritten in the .txt file and uploaded to the unit again.

Interpreter Status

This field displays whether the program is continuing to run, has stopped or finished, or if there are errors contained in the script. If there are errors in the script, the line on which the error occurred is displayed.

Upload BASIC Script

This field displays the script selected to be uploaded to the device. To upload a script to WebRelay-10, click the 'Choose File' button, find the .txt file previously written, and select 'Open.' The location of the file should appear in the neighboring field. To upload the script to the unit, select 'Submit.'

Run Script

This option selects whether or not the selected script will be run after it has been uploaded. The Submit button must be clicked to run the script.

External Variables

External Variables are variables that can be used in BASIC scripts. They are called External Variables because their values can be changed externally to the BASIC script using xml requests, or through the **Control Page**. This allows basic scripts to react to user input. These variables are considered to be floating point numbers, just like other variables in the BASIC script.

The following page is displayed when configuring External Variables:

Figure 2.4o - extVar Setup

External Variable

This drop down menu offers the option to configure each of the four External Variables.

Display State

Checking this box will display the state of the selected External Variable on the **Control Page**.

Display Button 1

Checking this box will display a button on the **Control Page**. Clicking this button on the **Control Page** will set the extVar to value 1.

Display Button 2

Checking this box will display a button on the **Control Page**. Clicking this button will set the extVar to value 2.

Display Input Box

Checking this box will display an input box on the **Control Page**. Entering a value on the **Control Page** in this field and clicking Set, will set the selected extvar to the new value. Values entered can be either positive or negative numbers.

Description

Text entered here will be displayed in the left column of the control page. Up to 24 characters may be entered here. The default text is extVar#.

Button 1 Label

This text field is used to describe the function of button 1 of the selected extVar. The text also appears to the right of the corresponding extVar status. Up to 14 characters may be entered here. By default, this text is **ON** for a value of 1.

Button 2 Label

This text field is used to describe the function of button 2 of the selected extVar. The text also appears to the right of the corresponding extVar status. Up to 14 characters may be entered here. By default, this text is **OFF** with a value of 0.

Status 1 Text

The text in this field specifies the text that will be displayed when the extVar is value 1, with a gray background. The text also appears in the status column on the **Control Page**. Up to 14 characters may be entered here. By default the text is **ON**.

Status 2 Text

The text in this field specifies the text that will be displayed when the extVar is value 0, with a gray background. The text also appears in the status column on the **Control Page**. Note that if the extVar is any other value than 1 or 0, the value will be displayed in the same column, with a gray background. Up to 14 characters may be entered here. By default the text is **OFF**.

2.4.12 Control Page Setup Tab

The **Control Page Setup** page is used mainly to set parameters that affect the view of the **Control Page**, how often it will refresh, etc.



Figure 2.4p - Control Page Setup Tab

Main Header Text

The text entered here appears at the top of the **Control Page**. It also appears in the header of the email text when the email notification is used. This field can be up to 40 characters in length. The default text is `WebRelay-10`.

Auto Refresh

The Auto Refresh Page option will cause the **Control Page** to continually update its contents by setting a timer in the web page that causes it to be reloaded at a specified time interval. When set to **Yes**, the web page will be refreshed at the time interval specified in the Refresh Rate setting. When set to **NO**, the web page will need to be manually refreshed to show the current status of the unit in the control page.

Refresh Rate

When the Auto Refresh Page option is set to **Yes**, this field specifies the time interval in seconds that the page will be refreshed. It can be set from 1 to 32 seconds.

Display Configuration

This field sets the options that are displayed on the **Control Page**.

- **Display State**: For Inputs 1 and 2, Relays 1-10, and Sensors 1-3, this controls whether the current states of the Relay, Input, and Sensor are displayed.
- **Display Counter**: When checked, the counter is displayed for the selected input.
- **Display Counter Reset Button**: When checked, a Reset button is displayed to reset the counter on the selected input.

- **Display On/Off Buttons:** When checked, an **ON** and **OFF** button is displayed for direct user control.
- **Display Pulse Button:** When checked, a button allowing a user to manually pulse a specified relay is displayed.

Note: Inputs, Counters, and Sensors are available on WebRelay-10 Plus™ only.

Section 3: Operation

WebRelay-10 can be operated using a web browser, by sending text commands to an XML status/control page, and/or by sending Modbus/TCP requests. In addition WebRelay-10 Plus™ model allows you to control the relays using inputs, or events. (Using an input or event to control the relays was described throughout previous sections of the manual, and will not be described here.)

3.1 Browser Operation

Once WebRelay-10 is set up, users can access the Control Page using a web browser by typing the IP address of WebRelay-10 into the web browser address bar. For example, using the default IP address, the user would enter `http://192.168.1.2`. If the IP address is changed from the default, the user must use the new IP address. Note that if any port is used other than the default port 80, the port must also be included in the request. For example, accessing the unit at port 8000 would be as follows: `http://192.168.1.2:8000`.

The following screen appears when the Control Page is Selected:

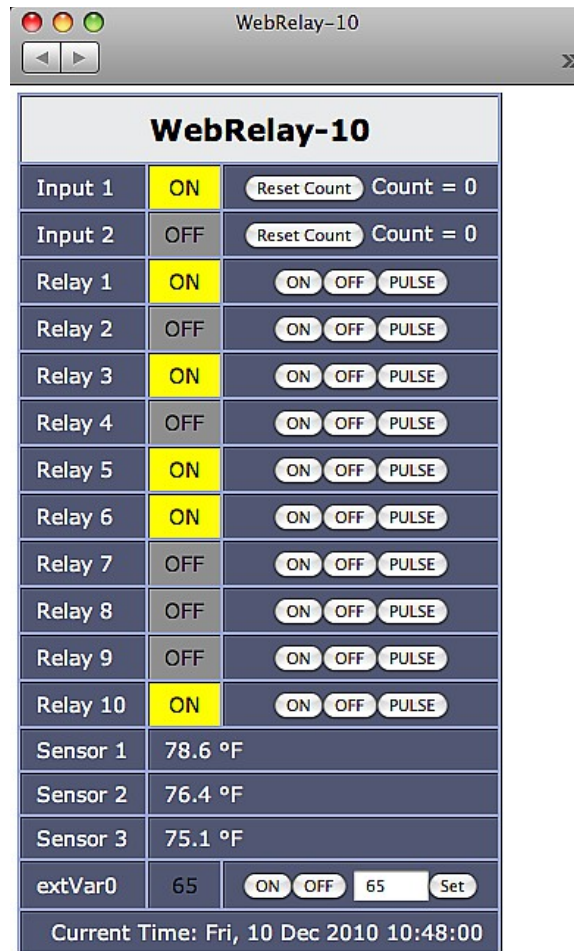

Figure 3.1a - Control Page

Header

Displays the text entered in the Main Header Text field on the **Control Page Setup** tab in the setup pages.

Input 1 and 2 (WebRelay-10 Plus™ only)

These rows display the current state of the two inputs. These rows can be displayed (as shown) or not displayed by checking or unchecking the appropriate boxes in the **Control Page Setup** tab in the setup pages. The text in the left column (by default reads Input 1 and Input 2) is specified in the Description field in the **Inputs** tab in the setup pages. The state of the input is shown to the right of the input description text. By default, the status text will read **ON** or **OFF**; however, the status text can be changed in the **Inputs** tab. To the right of the input status, a button is provided to reset the counter. The button will be shown when selected on the **Control Page Setup** tab.

Relays 1-10

These rows display the current state of the ten relays and allow the user to change the relay state. Each of these rows can be displayed (as shown) or not displayed by checking or unchecking the appropriate boxes on the **Control Page Setup** tab in the setup pages. The text in the left column (by default reads Relay 1, Relay 2, etc.) is specified in the Description field in the **Relays** tab in the setup pages. The state of the relay is shown to the right of the relay description text. By default, the status text will read **ON** or **OFF**; however, the status text can be changed in the **Relays** tab. To the right of the relay status, buttons are provided to control the relays. The buttons can be removed when needed (in the **Control Page Setup** tab) and the text within the buttons can be customized (in the **Relays** tab).

Sensor 1-8 (WebRelay-10 Plus™ only)

These rows display the current temperature or humidity measured by the associated sensors. Each row can be displayed (as shown) or not displayed by checking or unchecking the appropriate boxes under the **Control Page Setup** tab in the setup pages. The text in the left column (by default reads Sensor 1 through Sensor 8), is specified in the Sensor Description field under the Sensors tab in the setup pages.

External Variables

These rows display the current state of the five external variables. These rows can be displayed (as shown) or not displayed by checking or unchecking the appropriate boxes in the extvar setup page. The text in the left column is specified in the Description field on the extvar setup page. The state of the extvar is shown to the right of the description text. By default the status text will read **ON** or **OFF**. To the right of the extvar status, buttons and an input box are provided to control the state/value of the external variable.

Current Time (WebRelay-10 Plus™ only)

Displays the current time that is set using the **Date/Time** tab in the setup pages.

Note: If the sensors are not configured (sensor addresses selected for each sensor) or are unreadable, the display will read x.x rather than displaying a false numerical value.

3.2 XML Operation

Custom XML computer applications may be created to monitor and control WebRelay-10. This method does not use a web browser. Diagnostics.xml is available for troubleshooting and system monitoring.

3.2.1 state.xml

Monitoring

The state of the relays, inputs, and sensors can be monitored by sending a request to port 80 (or port specified in setup). This can be demonstrated by entering the following URL into the address bar of a web browser (substituting the IP address as necessary):

```
http://192.168.1.2/state.xml
```

The following state.xml page is returned:

```
<datavalues>
  <input1state>0</input1state>
  <input2state>0</input2state>
  <hightime1>0.000</hightime1>
  <hightime2>0.000</hightime2>
  <count1>0</count1>
  <count2>0</count2>
  <relay1state>0</relay1state>
  <relay2state>0</relay2state>
  <relay3state>0</relay3state>
  <relay4state>0</relay4state>
  <relay5state>0</relay5state>
  <relay6state>0</relay6state>
  <relay7state>0</relay7state>
  <relay8state>0</relay8state>
  <relay9state>0</relay9state>
  <relay10state>0</relay10state>
  <units>F</units>
  <sensor1temp>x.x</sensor1temp>
  <sensor2temp>x.x</sensor2temp>
  <sensor3temp>x.x</sensor3temp>
  <sensor4temp>x.x</sensor4temp>
  <sensor5temp>x.x</sensor5temp>
  <sensor6temp>x.x</sensor6temp>
  <sensor7temp>x.x</sensor7temp>
  <sensor8temp>x.x</sensor8temp>
  <extvar0>0.00</extvar0>
  <extvar1>0.00</extvar1>
  <extvar2>0.00</extvar2>
  <extvar3>0.00</extvar3>
  <extvar4>0.00</extvar4>
  <serialNumber>WebRelay-10 Serial Number</serialNumber>
  <time>1290165251</time>
</datavalues>
```

The numbers enclosed by the tags, <tag>, indicate the current state or value monitored by WebRelay-10. Values for each tag are described in the table below.

XML computer applications will open a TCP/IP socket with the WebRelay-10 and send a GET command followed by the state.xml command string.

XML Tags*	Monitor Values	Control Values	WebRelay-10 Plus™ Only
<inputXstate>	0 = Input OFF 1 = Input ON	n/a	X
<hightimeX>	The amount of time in seconds that the input was last on	n/a	X
<countX>	Current number of times the input has been counted (counting must be enabled)	n/a	X
<relayXstate>	0 = Relay OFF (coil off) 1 = Relay ON (coil energized)	0 = Turn relay OFF 1 = Turn relay ON 2 = Pulse relay 5 = Toggle the state of the relay	
<units>	F = Fahrenheit C = Celsius	n/a	X
<sensorXtemp>	x.x = Indicates that no digital temperature sensor is attached. 77.3 = Current temperature. H24.9 = Current humidity reading.	n/a	X
<extvarX>	Value of each External Variable.	n/a	
<serialNumber>	00:00:00:00:00:00, serial number of WebRelay-10.	n/a	
<time>	1253030401 = Time displayed in "epoch time" (number of seconds since January 1, 1970)	n/a	

* 'X' is replaced by the relay number or input number.

Control

relayXState commands can be sent to WebRelay-10 to control the relays. X is replaced by 1 for Relay 1, 2 for Relay 2, and so forth. The following are a few examples:

Command	Description
state.xml?relay1State=0	Turn Relay 1 OFF
state.xml?relay1State=1	Turn Relay 1 ON
state.xml?relay2State=0	Turn Relay 2 OFF
state.xml?relay2State=1	Turn Relay 2 ON

When the pulse command is sent, the relay will energize for the Pulse Duration specified in the **Relays** setup page. It is possible, however, to send a pulse time command that is different than the configured Pulse Duration. This is done by sending a pulseTime variable.

The pulseTime variable does not change the Pulse Duration in the setup page and it is not stored or recorded. The pulseTime variable only changes the duration for the single pulse initiated by that command. In other words, you must issue the pulseTime command for each pulse command that differs from the preset value.

For example, suppose the WebRelay-10 is configured for a Pulse Duration of 1.5 seconds. To issue one 1.5 second pulse, three 5 second pulses, and another 1.5 second pulse to Relay 1, you would issue

the following commands:

Command	Description
state.xml?relay1State=2	Pulse Relay 1 for the preset time (1.5 seconds).
state.xml?relay1State=2&pulseTime1=5	Pulse Relay 1 for 5 seconds.
state.xml?relay1State=2&pulseTime1=5	Pulse Relay 1 for 5 seconds.
state.xml?relay1State=2&pulseTime1=5	Pulse Relay 1 for 5 seconds.
state.xml?relay1State=2	Pulse Relay 1 for the preset time (1.5 seconds).

Message Acknowledgment

By default, when commands are sent to WebRelay-10, the state.xml page is returned. The xml reply can be disabled by adding the `noReply` field as follows:

Command	Description
state.xml?relay1State=1&noReply=1	Turn Relay 1 ON without returning state
state.xml?relay1State=0&noReply=1	Turn Relay 1 OFF without returning state

Password

If the Control Password is enabled on WebRelay-10 and the state.xml page is requested through a browser, the user will be prompted for a password. If the XML request is sent from an XML application, the html request will need to contain the password, encoded as Base64. The following is an html request header without the password:

```
GET /state.xml?relay1State=1&noReply=1 HTTP/1.1 (Terminated w/ two \r\n.)
```

The following example adds the password:

```
GET /state.xml?relay1State=1&noReply=1 HTTP/1.1 (Terminated with \r\n.)
```

```
Authorization: Basic bm9uZTp3ZWJyZWxheQ== (Terminated with two \r\n.)
```

`bm9uZTp3ZWJyZWxheQ==` is the Base64 encoded version of the user "name:password,"
none:webrelay.

A utility is provided at <http://www.controlbyweb.com/encoder> to encode the password. Simply type the string username:password into the website and press 'Encode'.

3.2.2 Monitoring Events Through eventX.xml (WebRelay-10 Plus™ only)

The relays can be configured to turn **ON**, turn **OFF**, or pulse at specified times. Instructions to change the relay state at a given time (or periodically) are called events. WebRelay-10 Plus™ supports 100 events, which can be monitored through the eventX.xml page (where X is the event number 0-99). This can be demonstrated by entering the following URL into the address bar of a web browser:

```
http://192.168.1.2/event0.xml
```

The following event.xml page is returned:

```
<event0>
  <active>yes</active>
  <currentTime>11/14/2010 15:14:09</currentTime>
  <nextEvent>11/15/2010 15:15:00</nextEvent>
  <period>1 d</period>
  <count>0</count>
  <relay>1</relay>
  <action>turn relay(s) on</action>
  <pulseDuration>0.5 s</pulseDuration>
</event0>
```

The tags used by WebRelay-10 are described below:

Tags*	Description								
<eventX>	Event tag where X represents the event number (0-99).								
<active>	This field indicates whether or not the event is active. The text <i>yes</i> indicates that the event is active and the event will occur at the next event time. The text <i>no</i> indicates that the event is inactive and the event will no longer take place.								
<currentTime>	This field indicates the current date and time as MM/DD/YYYY HH:MM:SS in 24-hour format.								
<nextEvent>	The next time the event is scheduled to occur is given as MM/DD/YYYY HH:MM:SS. If an event is inactive, this field will display the date and time as xx/xx/xxxx xx:xx:xx.								
<period>	For events that occur more than one time, this field indicates the period of the event (time between event occurrences). The unit of time is indicated after the value (seconds (s), minutes (m), hours (h), days (d), or weeks (w)). If this field is set to 0, then the event has been disabled. For example 1d would be a period of 3 days.								
<count>	This field indicates the number of remaining times the event will occur. If this field is 0 and the event is active, then the event is always on.								
<relay>	Event will apply to the relay specified (1-10).								
<action>	One of the follow actions is applied to the event. <table style="width: 100%; border: none;"> <tr> <td style="width: 50%;">turn relay(s) on</td> <td style="width: 50%;">turn relay(s) off</td> </tr> <tr> <td>pulse relay(s)</td> <td>toggle relay(s)</td> </tr> <tr> <td>set extVar0</td> <td>clear extVar0</td> </tr> <tr> <td>change schedules</td> <td></td> </tr> </table>	turn relay(s) on	turn relay(s) off	pulse relay(s)	toggle relay(s)	set extVar0	clear extVar0	change schedules	
turn relay(s) on	turn relay(s) off								
pulse relay(s)	toggle relay(s)								
set extVar0	clear extVar0								
change schedules									
<pulseDuration>	This field indicates the time (in seconds) that the relay will energized.								

* 'X' is replaced by the relay number or input number.

3.2.3 XML Diagnostics

There is a special diagnostics.xml can be requested by by entering the following in the web browser address bar:

```
http://192.168.1.2/diagnostics.xml
```

The following diagnostics.xml file is returned.

```
<datavalues>
  <memoryPowerUpFlag>1</memoryPowerUpFlag>
  <devicePowerUpFlag>1</devicePowerUpFlag>
  <powerLossCounter>1</powerLossCounter>
</datavalues>
```

Diagnostic tags are given in the table below.

Tag	Description
<memoryPowerUpFlag> (WebRelay-10 Plus™ only)	A loss of power to the capacitor-backed real-time clock is indicated by a value of 1. The internal capacitor can power the real-time clock for several days when main power is lost. If the real-time-clock loses power, the time will have to be reset. By default, the flag value is 1. It is not automatically set and will read 1 until it is explicitly set to 0, as described below.
<devicePowerUpFlag>	Loss of power to the device is indicated by 1. A value of 1 means WebRelay-10 has lost power at least one time since the flag was set to 0. By default, the flag value is 1. It is not automatically set and will read 1 until it is explicitly set to 0, as described below.
<powerLossCounter>	This field is a count of how many times WebRelay-10 has lost main power. It may be reset to 0.

The above flags may be cleared by requesting the diagnostics.xml file along with request parameters.

To clear the real-time-clock power loss flag:

```
http://192.168.1.2/diagnostics.xml?memoryPowerUpFlag=0
```

To clear the device power loss flag:

```
http://192.168.1.2/diagnostics.xml?devicePowerUpFlag=0
```

To clear the powerLossCounter flag:

```
http://192.168.1.2/diagnostics.xml?powerLossCounter=0
```

Resetting of multiple flags may be done at one time by placing & between each request:

```
http://192.168.1.2/diagnostics.xml?memoryPowerUpFlag=0&devicePowerUpFlag=0
```

Note: Requests for the diagnostics.xml file do not require a password.

3.3 Configuring Events Through GET Requests (WebRelay-10 Plus™ only)

Events can be configured using a GET request. For example, to configure event 5 to start on November 19, 2010 at 12:00:00 and continue every day, turning Relay 1 on, send the following request (using the default IP address):

```
http://192.168.1.2/eventSetup.srv?
e5=1290168000;1;3;0;0;1;4;0;Event5Desc;127;1;
```

The basic format of the request is:

e(event#)=epoch time;period;period units;count;schedule#;action;pulse duration;0;description;days;action#;

Parameter	Description
e5=	Parameter Name: Each event has an identifier (0-99). In this case the parameter name is e5. Event 100 would be e99.
1290168000	Epoch Time: The number of seconds up to the desired start date since January 1, 1970.
1	Period: The period value.
3	Period Units: The units of the period, 0-Seconds, 1-Minutes, 2-Hours, 3-Days, 4-Weeks.
0	Count: Number of times the event will occur. (0 = continuous)
0	Schedule #: The schedule where the event will occur (0-4). 0 = schedule 0, 1 = schedule 1, and so forth.
1	Action: 0-No Action, 1-Turn relay on, 2-Turn relay off, 3-Pulse relay, 4-Toggle relay, 5-change schedules, 7-Set extVar0, 8-Clear extVar0.
4	Pulse Duration: Pulse duration when using the pulse relay action.
0	Next Occurrence: This is a report value only, indicating the next time this event will occur in Epoch Time. When setting an event leave this at 0.
Event5Desc;	Description: Text description of the event, up to 20 characters can be entered.
127	Days: This number represents which days the event will occur. This value is the base ten version of a binary number where each bit represents one day of the week. Bit 0 is Saturday and Bit 6 is Sunday. See the table below for some common values.
1	Action #: This number represents which relay will be affected by the event. This value is the base ten version of a binary number where each bit represents the ON/OFF state of one relay. Bit 0 corresponds to relay/schedule 1, and Bit 9 corresponds with Relay 10.

3.3.1 Common Base Ten Values for Event Days

Sun	Mon	Tues	Wed	Thurs	Fri	Sat	Base 10 Value
Bit 6	Bit 5	Bit 4	Bit 3	Bit 2	Bit 1	Bit 0	--
1	1	1	1	1	1	1	127
0	1	1	1	1	1	0	62
0	1	0	1	0	1	0	42
0	0	1	0	1	0	0	20
0	0	0	0	0	0	1	1

3.4 Modbus Operation

WebRelay-10 can be controlled and monitored using Modbus/TCP protocol. This provides a standard means of using WebRelay-10 with devices and software from other manufacturers. This section is not a tutorial on Modbus and it is assumed that the reader is already familiar with Modbus. Detailed Modbus information can be found at <http://www.modbus.org>.

Note: Modbus communications are disabled whenever the Control Password is enabled. This is because Modbus/TCP does not provide a mechanism for password protection. Make sure the Control Password is disabled (default) and Modbus functionality is enabled on the Advanced Network.

WebRelay-10 functions as a Modbus slave. Host devices, such as PLCs, open a connection with WebRelay-10 on port 502 (configurable under **Advanced Network** tab) and then send requests to read or set relay states, read input states, or read sensor values. When WebRelay-10 receives a command, it will perform the desired function and return a response.

3.4.1 WebRelay-10 Function Code Summary

WebRelay-10 supports the following function codes:

Code Name	Modbus Function	Feature	WebRelay Address	Data Type	Manual Section
Read Coils	01	Relays 1-10	0-9	Discrete	3.4.4
Read Discrete Inputs	02	Inputs 1-2	0-1	Discrete	3.4.5
Read Sensors	03	Sensors 1-8	272-286	32-bit	3.4.6
Write Single Coil	05	Relays 1-10	0-9	Discrete	3.4.7
Write Multiple Coils	15	Relays 1-10	0-9	Discrete	3.4.8
Pulse Coils	16	Relays 1-10	0-9	32-bit	3.4.9

Multiple commands may be sent without closing and re-opening the connection, but if no data is transferred for 50 seconds, the connection will time out and close. To keep the connection open, a read request can be sent periodically.

WebRelay-10 has two TCP sockets available for Modbus/TCP. This allows two connections to be open at one time. Requests for more than two open connections will be rejected.

When errors occur, an error code is returned. Most Modbus client software will interpret this code in a human readable form. The code is comprised of the original function code plus 0x80. For example, an error during the read coils function 0x01 would return 0x81. Each error has a qualifying exception number. The following are the possible exception codes and their meanings:

0x01 - Function code not supported (also when Modbus is disabled in the setup pages).

0x02 - Incorrect starting address/quantity of relays combination.

The structure of these commands is described in the following sections..

3.4.2 PLC Device Addressing

There are generally two schemes for accessing Modbus devices, The first is by specifying the Modbus function code, memory type, and address. The second, sometimes called PLC addressing, requires only the address.

Modbus protocol uses four different address ranges for discrete inputs, coils, input registers, and holding registers. The function code determines the address range of the message. The following are common function codes and their respective address ranges.

Code Name	Modbus Function	Data Type*	PLC Address Mode 485	PLC Address Mode 584/984
Coils (Read/Write)	01, 05, 15	Discrete	1-1000	1-10000
Discrete Inputs (Read only)	02	Discrete	1001-2000	10001-20000
Registers (Read only)	04	8-64 bits	3001-4000	30001-40000
Holding Registers (Read/Write)	03, 06, 16	8-64 bits	4001-5000	40001-50000

* Data types may be implemented at the discretion of the manufacturer. Address ranges may also overlap. Discrete is a binary or boolean value, 1 or 0.

Function codes, memory types, and addresses can be converted to the PLC addressing equivalent using the table below. To use the table, look up the row corresponding to the Modbus function code. Then take the desired WebRelay-10™ feature address and add to it the address offset in the PLC address mode column.

{input address} + {PLC address range} = PLC address

For example, to read discrete Input 2, the Modbus function code 02 is used. Adding the address of Input 2, 1, to the address range, 1001, gives a PLC address of 1002. Programming the PLC to read from 1002 will return the value of Input 2.

Code Name	Modbus Function	WebRelay Addresses	Data Type	PLC Address Mode 485	PLC Address Mode 584/984
Read Coils	01	0-9 (Relays 1-10)	Discrete	Addr + 1	Addr + 1
Read Discrete Inputs*	02	0-1 (Inputs 1-2)	Discrete	Addr + 1001	Addr + 10001
Read Holding Registers*	03	272-286 (Sensors 1-8)	32-bit	Addr + 4001	Addr + 40001
Write Coils	05	0-9 (Relays 1-10)	Discrete	Addr + 1	Addr + 1
Write Multiple Coils	15	0-9 (Relays 1-10)	Discrete	Addr + 1	Addr + 1
Write Multiple Registers	16	0-9 (Relays 1-10)	32-bit	Addr + 1	Addr + 1

* WebRelay-10 Plus™ only

For 32-bit numbers, two registers must be read starting at the desired address, examples of each are given for the applicable functions.

3.4.3 WebRelay-10 Full Address Table

The table below gives commonly used function code, memory types, data sizes, and equivalent PLC addresses for accessing the WebRelay-10. The data size will be the same regardless of the addressing mode.

	Function Code	Address	Data Size	PLC Address Mode 485	PLC Address Mode 584/984	Section
Read Relay 1	01	0	Discrete	1	1	
Read Relay 2	01	1	Discrete	2	2	
Read Relay 3	01	2	Discrete	3	3	
Read Relay 4	01	3	Discrete	4	4	
Read Relay 5	01	4	Discrete	5	5	
Read Relay 6	01	5	Discrete	6	6	
Read Relay 7	01	6	Discrete	7	7	
Read Relay 8	01	7	Discrete	8	8	
Read Relay 9	01	8	Discrete	9	9	
Read Relay 10	01	9	Discrete	10	10	
Write Relay 1	05	0	Discrete	1	1	
Write Relay 2	05	1	Discrete	2	2	
Write Relay 3	05	2	Discrete	3	3	
Write Relay 4	05	3	Discrete	4	4	
Write Relay 5	05	4	Discrete	5	5	
Write Relay 6	05	5	Discrete	6	6	
Write Relay 7	05	6	Discrete	7	7	
Write Relay 8	05	7	Discrete	8	8	
Write Relay 9	05	8	Discrete	9	9	
Write Relay 10	05	9	Discrete	10	10	
Read Input 1 State	02	0	Discrete	1001	10001	
Read Input 2 State	02	1	Discrete	1002	10002	
Read Sensor 1	03	272	32-bit Float	4273	40273	
Read Sensor 2	03	274	32-bit Float	4275	40275	
Read Sensor 3	03	276	32-bit Float	4277	40277	
Read Sensor 4	03	278	32-bit Float	4279	40279	
Read Sensor 5	03	280	32-bit Float	4281	40281	
Read Sensor 6	03	282	32-bit Float	4283	40283	
Read Sensor 7	03	284	32-bit Float	4285	40285	
Read Sensor 8	03	286	32-bit Float	4287	40287	
Write Multiple Relays	15	0	8 or 16-bit	1	1	
Pulse Relays	16	0	32-bit Float	1	1	

3.4.4 Read Coils - Modbus Function Code 01 (0x01)

This function returns the state of the relay coils. 0 denotes that the coil is not energized, 1 denotes that the coil is energized.

Request

Valid starting address can fall in the range of 0x0000 and 0x0009. Relay 1 is at address 0x0000, Relay 2 is at address 0x0001, Relay 3 is at address 0x0002, and so forth. Multiple relays may be read at the same time by specifying the correct starting address and quantity of coils to be read.

Start Address: 0x0000 (coil 1) to 0x0009 (coil 10)

Coil Quantity: 0x0001 (1 coil) to 0x000A (10 coils)

The sum of the start address and coil count cannot exceed the maximum coil count or an error response will be returned.

Modbus TCP Request Frame Example – Read Coils 2 through 10			
Field Name	Length	Function	Example Data
Transaction Identifier	2 bytes	Synchronization number.	0x0001
Protocol Identifier	2 bytes	Zero for Modbus/TCP	0x0000
Message Length	2 bytes	Number of bytes in frame (below)	0x0006
Unit Identifier	1 byte	Slave Address (0xff if not used)	0xFF
Function Code	1 byte	Read Coils	0x01
Data	4 bytes	Start Address (0x0000-0x0009) Quantity of coils to read (0x0001-0x000A)	0x0001 0x0009

Tx String: 00 01 00 00 00 06 FF 01 00 01 00 09

Response

The WebRelay-10 will respond to the request with a data field of one or two bytes, each bit representing the coil status. A '1' indicates the relay is **ON**. A '0' indicates that the relay is **OFF**. A single byte is returned if no more than 8 coils are requested. Two bytes are returned if the status of nine or 10 coils are requested.

Consequently, the message length will be 0x0004 bytes or 0x0005 bytes, depending on the number of coils.

Bit zero of the return value will be the state of the coil corresponding to the start address. For example, if a start address of 0x0006 is used, bit zero will be the status of coil 7. The tables below show two examples.

Coil status for relays 7-9, start address of 0x0006 and quantity of 3:

Single Byte							
Bit 7	6	5	4	3	2	1	Bit 0
X	X	X	X	X	Relay 9	Relay 8	Relay 7

Full, 10-bit return value:

Upper Byte								Lower Byte							
Bit 15	14	13	12	11	10	9	8	7	6	5	4	3	2	1	Bit 0
X	X	X	X	X	X	Relay 10	9	8	7	6	5	4	3	2	Relay 1

WebRelay-10 Response Frame Example – Status of Coils 2 through 10			
Field Name	Length	Function	Example Data
Transaction Identifier	2 bytes	Synchronization number.	0x0001
Protocol Identifier	2 bytes	Zero for Modbus/TCP	0x0000
Message Length	2 bytes	Number of bytes in frame (below)	0x0004
Unit Identifier	1 byte	Slave Address (0xff if not used)	0xFF
Function Code	1 byte	Read Coils	0x01
Data	2-3 bytes	Byte Count (0x01-0x02) Coil status lower byte (0x00 to 0x03FF) Coil status upper byte	0x02 0x55 0x01

RX String: 00 01 00 00 00 04 FF 01 02 55 01

Errors

The following are possible error responses for function code 0x01.

Coil Read Error Function Code (1 byte): 0x81

Exception Codes (1 byte): 0x01 – Function code not supported.

0x02 – Incorrect combination of start address and quantity of relays

Error Response Frame Example			
Field Name	Length	Function	Example Data
Transaction Identifier	2 bytes	Synchronization between messages of server and client.	0x0001
Protocol Identifier	2 bytes	Zero for Modbus/TCP	0x0000
Message Length	2 bytes	Number of bytes in frame (below)	0x0003
Unit Identifier	1 byte	Slave Address (0xff if not used)	0xFF
Function Code	1 byte	Function code	0x81
Data	1 byte	Exception code (0x01 - 0x02)	0x02

Rx String: 00 01 00 00 00 03 FF 81 02

3.4.5 Read Discrete Inputs – Modbus Function Code 02 (0x02) (WebRelay-10 Plus™ only)

This function returns the state of the discrete inputs.

Start Address: 0x0000 (input1) to 0x0001 (input 2)

Input Quantity: 0x0001 to 0x0002

The sum of the starting address and the quantity of coils must not be greater than 0x0002. For example, if you want to read 0x0002, both inputs, then the start address must be 0x0000. To read the second input only the start address is 0x0001 with a quantity of 0x0001.

Request

Modbus TCP Request Frame Example – Read Inputs 1 - 2			
Field Name	Length	Function	Example Data
Transaction Identifier	2 bytes	Synchronization number.	0x0001
Protocol Identifier	2 bytes	Zero for Modbus/TCP	0x0000
Message Length	2 bytes	Number of bytes in frame (below)	0x0006
Unit Identifier	1 byte	Slave Address (0xff if not used)	0xFF
Function Code	1 byte	Read Inputs	0x02
Data	4 bytes	Start Address (0x0000-0x0001) Quantity (0x0001-0x0002)	0x0000 0x0002

TX String: 00 01 00 00 00 06 FF 02 00 00 00 02

Response

The inputs states are indicated by bits one and two of the status byte. A 1 indicates that the input is switched to ground (**ON**). A 0 indicates that the input is open (**OFF**).

Data Byte (hex)	LS Data Bits (binary)	Input 2 State	Input 1 State
0x00	0000	OFF	OFF
0x01	0001	OFF	ON
0x02	0010	ON	OFF
0x03	0011	ON	ON

WebRelay-10 Response Frame Example – Inputs 1 and 2 ON			
Field Name	Length	Function	Example Data
Transaction Identifier	2 bytes	Synchronization number.	0x0001
Protocol Identifier	2 bytes	Zero for Modbus/TCP	0x0000
Message Length	2 bytes	Number of bytes in frame (below)	0x0006
Unit Identifier	1 byte	Slave Address (0xff if not used)	0xFF
Function Code	1 byte	Read Inputs	0x02
Data	2 bytes	Byte count (0x01) Input State (0x00-0x03)	0x01 0x03

RX String: 00 01 00 00 00 04 FF 02 01 03

Errors

Input Read Error Function Code (1 Byte): 0x82

Exception codes (1 Byte): 0x01 – Function not supported.

0x02 – Incorrect combination of start address and input quantity.

Error Response Frame Example			
Field Name	Length	Function	Example Data
Transaction Identifier	2 bytes	Synchronization between messages of server and client.	0x0001
Protocol Identifier	2 bytes	Zero for Modbus/TCP	0x0000
Message Length	2 bytes	Number of bytes in frame (below)	0x0003
Unit Identifier	1 byte	Slave Address (0xff if not used)	0xFF
Function Code	1 byte	Error code	0x82
Data	1 byte	Exception code (0x01 - 0x02)	0x02

Rx String: 00 01 00 00 00 03 FF 82 02

3.4.6 Read Sensors – Modbus Function Code 03 (0x03) (WebRelay-10 Plus™ only)

The Read Holding Registers function is used for the temperature or humidity sensors.

32-bit sensor values are read from 16-bit register pairs. Consequently, sensors addresses and registers must be even numbers.

Start Address (2 bytes): 0x0110, 0x0112 ... 0x011E (Sensors 1, 2 ... 8 respectively)

Sensor Register Count (2 bytes): 0x02, 0x04 ... 0x10

Request

Modbus TCP Request Frame Example – Read Sensor 1 and 2			
Field Name	Length	Function	Example Data
Transaction Identifier	2 bytes	Synchronization number.	0x0001
Protocol Identifier	2 bytes	Zero for Modbus/TCP	0x0000
Message Length	2 bytes	Number of bytes in frame (below)	0x0005
Unit Identifier	1 byte	Slave Address (0xff if not used)	0xFF
Function Code	1 byte	Read Sensors	0x03
Data	3 bytes	Start Address (0x0110, 0x0112 ... 0x011E) Sensor Count (0x02, 0x04 ... 0x10)	0x0110 0x0004

TX String: 00 01 00 00 00 05 FF 03 01 10 00 04

Response

Each value is returned as two registers in IEEE 754 floating point formats. The four data bytes are treated as two individual big-endian 16-bit words with the least significant word being sent first. In other words, the 32-bit floating point number represented as '1234 ABCD' is sent as ABCD 1234.' For example, if we were to read two registers starting at address 0x110, and Sensor 1 measured the temperature to be 81.25 degrees, then we would get the following value 800042A2. The least significant word would be 8000 hex and the most significant word would be 42A2. Using a conversion utility, we could then convert this hexadecimal value into the temperature reading of 81.25 degrees.

The device returns a value of 0xFFFFFFFF (NaN) if there isn't a valid reading or when the sensor isn't active.

WebRelay-10 Response Frame Example – Sensor 1 and 2			
Field Name	Length	Function	Example Data
Transaction Identifier	2 bytes	Synchronization number.	0x0001
Protocol Identifier	2 bytes	Zero for Modbus/TCP	0x0000
Message Length	2 bytes	Number of bytes in frame (below)	0x000C
Unit Identifier	1 byte	Slave Address (0xff if not used)	0xFF
Function Code	1 byte	Read Sensors	0x03
Data	10-14 bytes	Byte Count (0x04 – 0x0C) Sensor Value (0x00000000 – 0xFFFFFFFF) Sensor Value (0x00000000 – 0xFFFFFFFF)	0x0008 0x999A41B1 0xB85142D2

RX String: 017-Rx:00 01 00 00 00 0B FF 03 08 99 9A 41 B1 B8 51 42 D2

Errors

Sensor Read Error Function Code (1 byte): 0x83

Exception Codes (1 byte): 0x01 – Function not supported.
 0x02 – Incorrect combination of start address and input quantity

Error Response Frame Example			
Field Name	Length	Function	Example Data
Transaction Identifier	2 bytes	Synchronization between messages of server and client.	0x0001
Protocol Identifier	2 bytes	Zero for Modbus/TCP	0x0000
Message Length	2 bytes	Number of bytes in frame (below)	0x0003
Unit Identifier	1 byte	Slave Address (0xff if not used)	0xFF
Function Code	1 byte	Error code	0x83
Data	1 byte	Exception code (0x01 - 0x02)	0x02

RX String: 00 01 00 00 00 03 FF 83 02

3.4.7 Write Single Coil – Modbus Function Code 05 (0x05)

This function allows you to control relays one at a time.

Relay Address (2 bytes): 0x0000 (Relay 1) – 0x00009 (Relay 10)

Relay Value (1 byte): 0x00 (ON), 0xFF(OFF)

Padding (1 byte): 0x00

Request

Modbus TCP Request Frame Example – Write Coil 3 ON			
Field Name	Length	Function	Example Data
Transaction Identifier	2 bytes	Synchronization number.	0x0001
Protocol Identifier	2 bytes	Zero for Modbus/TCP	0x0000
Message Length	2 bytes	Number of bytes in frame (below)	0x0006
Unit Identifier	1 byte	Slave Address (0xff if not used)	0xFF
Function Code	1 byte	Write Coil	0x05
Data	4 bytes	Relay address (0x0000 – 0x0009) Relay value (0x00, 0xFF) Padding (0x00)	0x0002 0xFF 0x00

Tx String: 00 01 00 00 00 06 FF 05 00 02 FF 00

Response

WebRelay-10 Response Frame Example – Write Coil 3 ON			
Field Name	Length	Function	Example Data
Transaction Identifier	2 bytes	Synchronization number.	0x0001
Protocol Identifier	2 bytes	Zero for Modbus/TCP	0x0000
Message Length	2 bytes	Number of bytes in frame (below)	0x0006
Unit Identifier	1 byte	Slave Address (0xff if not used)	0xFF
Function Code	1 byte	Write coil	0x05
Data	4 bytes	Relay address (0x0000 - 0x0009) Relay value (0xFF, 0x00) Padding (0x00)	0x0003 0xFF 0x00

Rx String: 00 01 00 00 00 06 FF 05 00 02 FF 00

Errors

Single Coil Write Error Function Code (1 Byte): 0x85

Exception codes (1 Byte): 0x01 – Function not supported.

0x02 – Address out of range.

0x03 – Incorrect relay value or padding value.

Error Response Frame Example			
Field Name	Length	Function	Example Data
Transaction Identifier	2 bytes	Synchronization between messages of server and client.	0x0001
Protocol Identifier	2 bytes	Zero for Modbus/TCP	0x0000
Message Length	2 bytes	Number of bytes in frame (below)	0x0003
Unit Identifier	1 byte	Slave Address (0xff if not used)	0xFF
Function Code	1 byte	Error code	0x85
Data	1 byte	Exception code (0x01 - 0x02)	0x02

RX String: 00 01 00 00 00 03 FF 85 03

3.4.8 Write Multiple Coils - Modbus Function Code 15 (0x0F)

One to two bytes can be written to set the state of all 10 relays, each bit representing one relay. The least significant bit of the lower byte represents Relay 1 and the 2nd bit of upper byte representing Relay 10.

Upper Byte								Lower Byte							
Bit 15	14	13	12	11	10	9	8	7	6	5	4	3	2	1	Bit 0
X	X	X	X	X	X	Relay 10	9	8	7	6	5	4	3	2	Relay 1

Start Address (2 bytes): 0x0000 (relay 1) – 0x0009 (relay 10)
 Relay Quantity (2 bytes): 0x0001 – 0x000A
 Byte Count (1-2 bytes): 0x01 – 0x02
 Output Value (1-2 bytes): 0x0000 – 0x03FF

Request

Relay states are controlled by specifying the start address of the first relay to be controlled, the count of the relays to be affected, and the relay state byte(s). Only the lower byte needs to be specified when relays 1 - 8 are changed. Both bytes must be specified if relays 9 or 10 are affected.

Field Name	Length	Function	Example Data
Transaction Identifier	2 bytes	Synchronization number.	0x0001
Protocol Identifier	2 bytes	Zero for Modbus/TCP	0x0000
Message Length	2 bytes	Number of bytes in frame (below)	0x0009
Unit Identifier	1 byte	Slave Address (0xff if not used)	0xFF
Function Code	1 byte	Write Multiple Coils	0x0F
Data	8-9 bytes	Start address (0x0000 – 0x0009) Relay quantity (0x0001 – 0x000A) Byte count (0x01 – 0x02) Lower byte value (0x00 – 0xFF) Upper byte value (0x00 – 0x03)	0x0006 0x0003 0x01 0x05

TX String: 00 01 00 00 00 08 FF 0F 00 06 00 03 01 05

Only coils that are in the address and count range will be affected by the output value. Consequently, an output value of 0xFFFF would be used to energized all of the relays in the range or 0x0000 to turn them **OFF**. In the above example, the output value 0xFF would turn relays 7-9 ON.

Response

WebRelay-10 Response Frame Example – Write Coils 7-9 ON			
Field Name	Length	Function	Example Data
Transaction Identifier	2 bytes	Synchronization number.	0x0001
Protocol Identifier	2 bytes	Zero for Modbus/TCP	0x0000
Message Length	2 bytes	Number of bytes in frame (below)	0x0004
Unit Identifier	1 byte	Slave Address (0xff if not used)	0xFF
Function Code	1 byte	Write Multiple Coils	0x0F
Data	4 bytes	Start address (0x0000 – 0x0009) Relay count (0x0001 – 0x000A)	0x0006 0x0003

RX String: 00 01 00 00 00 06 FF 0F 00 06 00 03

Errors

Multiple Coil Write Error Function Code (1 Byte): 0x8F

Exception codes (1 Byte): 0x01 – Function not supported.

0x02 – Incorrect combination of start address and relay quantity

0x03 – Byte count out of range.

Error Response Frame Example			
Field Name	Length	Function	Example Data
Transaction Identifier	2 bytes	Synchronization between messages of server and client.	0x0001
Protocol Identifier	2 bytes	Zero for Modbus/TCP	0x0000
Message Length	2 bytes	Number of bytes in frame (below)	0x0003
Unit Identifier	1 byte	Slave Address (0xff if not used)	0xFF
Function Code	1 byte	Error code	0x8F
Data	1 byte	Exception code (0x01 – 0x02)	0x02

Rx String: 00 01 00 00 00 03 FF 8F 03

3.4.9 Pulse Coils – Modbus Function Code 16 (0x10)

The Modbus Write Multiple Registers function is used to pulse the relay(s) for a specified time. When WebRelay-10 receives this command, it immediately turns the appropriate relay coil(s) **ON** (if not already on) and starts the pulse timer. The relay(s) are selected by writing the pulse time to the register(s) associated with the appropriate relay(s). The pulse time is specified in the register value field and can range from 0.1 seconds to 86400 seconds (1 day). When the pulse time expires, the relay coil will be turned **OFF**. If a pulse time command is sent with a value greater than 86400, the pulse timer will be set to 86400. If a pulse time command is sent with a value less than 0.1, the pulse timer will be set to 0.1. If any commands are sent to WebRelay-10 (Modbus, xml, or html) before the pulse timer has expired, the pulse timer will be canceled immediately and the new command will be executed.

The pulse time is provided in IEEE 754 floating point format. The four data bytes are treated as two individual big endian 16-bit words but, the least significant word is sent first. In other words, the 32-byte floating point number represented as 1234 ABCD is sent ABCD 1234. In the example shown below, the relay will pulse for 10 seconds. Ten seconds is represented using a floating point number of 41200000. It is transferred as 00004120.

Pulse Coil Function Code (1 byte): 0x10
 Start Address (2 bytes): 0x0010 (relay 1) – 0x0022 (relay 10)
 Register Quantity (2 bytes): 0x0002 – 0x0014 (2 registers for each relay, even number)
 Byte Count (1 byte): 0x04 – 0x28 (Multiples of 4)
 Pulse Duration (4 bytes, per relay): 0x3DCCCCC – 0x47A8C000
 (Little-endian Format: 0xCCCC3DCC – 0xC00047A8)

Request

Relay Number	Relay Address
1	0x0010
2	0x0012
3	0x0014
4	0x0016
5	0x0018

Relay Number	Relay Address
6	0x001A
7	0x001C
8	0x001E
9	0x0020
10	0x0022

Modbus TCP Request Frame Example – Pulse Coil 4 for .5 s and Coil 5 for 5 s			
Field Name	Length	Function	Example Data
Transaction Identifier	2 bytes	Synchronization number.	0x0001
Protocol Identifier	2 bytes	Zero for Modbus/TCP	0x0000
Message Length	2 bytes	Number of bytes in frame (below)	0x000F
Unit Identifier	1 byte	Slave Address (0xff if not used)	0xFF
Function Code	1 byte	Pulse Coils (Write Multiple Registers)	0x10
Data	8-42 bytes	Start address (0x0010 – 0x0022) Register quantity (0x0002 – 0x0014) Byte count (0x04 - 0x28) Pulse Duration (0xCCCC3DCC – 0xC00047A8)	0x0016 0x0004 0x08 0x00003F00 0x000040A0

Tx String: 00 01 00 00 00 0F FF 10 00 16 00 04 08 00 00 3F 00 00 00 40 A0

Response

WebRelay-10 Response Frame Example – Write Coils 7-9 ON			
Field Name	Length	Function	Example Data
Transaction Identifier	2 bytes	Synchronization number.	0x0001
Protocol Identifier	2 bytes	Zero for Modbus/TCP	0x0000
Message Length	2 bytes	Number of bytes in frame (below)	0x0004
Unit Identifier	1 byte	Slave Address (0xff if not used)	0xFF
Function Code	1 byte	Write Multiple Coils	0x0F
Data		Start address (0x0000 – 0x0009) Relay count (0x0001 – 0x000A)	0x0006 0x0003

Rx String: 00 01 00 00 00 06 FF 10 00 16 00 04

Errors

Pulse Function code Error (1 Byte):

0x90

Exception codes (1 Byte):

0x01 – Feature not supported.

0x02 – Address quantity not an even number.

Incorrect combination of start address and relay count.

Error Response Frame Example			
Field Name	Length	Function	Example Data
Transaction Identifier	2 bytes	Synchronization between messages of server and client.	0x0001
Protocol Identifier	2 bytes	Zero for Modbus/TCP	0x0000
Message Length	2 bytes	Number of bytes in frame (below)	0x0003
Unit Identifier	1 byte	Slave Address (0xff if not used)	0xFF
Function Code	1 byte	Error code	0x90
Data	1 byte	Exception code (0x01 – 0x02)	0x02

Rx String: 00 01 00 00 00 03 FF 90 02

3.5 Email Notification

3.5.1 Email Notification Description

WebRelay-10 can be configured to send messages to five email addresses when certain events occur. Events that can trigger email messages include input state changes, relay state changes, temperature/humidity changes, and commands sent from a BASIC script.

When an email message is sent, it looks similar to this:

```
WebRelay-10
Trigger: Relay 1: ON
Input 1: ON
Input 2: OFF
Relay 1: ON
Relay 2: OFF
Relay 3: OFF
Relay 4: OFF
Relay 5: OFF
Relay 6: OFF
Relay 7: OFF
Relay 8: OFF
Relay 9: OFF
Relay 10: OFF
Sensor 1: 73.5
Sensor 2: xx.x
Sensor 3: xx.x
Sensor 4: xx.x
Sensor 5: xx.x
Sensor 6: xx.x
Sensor 7: xx.x
Sensor 8: xx.x
```

*Note: Input, relay, and sensor names as well as **ON** and **OFF** status text may be customized by the user (installer) in the setup pages. The same field names are used in the **Control Page**.*

Note: Inputs, and Sensors are only available on WebRelay-10 Plus.

Subject Line

The top line (that reads WebRelay-10), appears in the subject line of the email message. This is the same text that appears as the header on the **Control Page**. It is set in the Main Header Text field under the **Control Page Setup** tab.

Trigger

The first line displayed in the body of the message shows the event that triggered the message. The text "Trigger" will always appear and cannot be changed. The remaining text includes the trigger name, the current state of the relay or input, or the current temperature/humidity of the sensor. The text that describes the trigger and its current state are configured in the setup pages as described below.

Current Status of Relays, Inputs, and Sensors

The remainder of the email message will display the same information shown on the **Control Page**. Fields not displayed in the **Control Page** will not be included in the email message. Displayed fields may be configured in the **Control Page Setup** page.

3.5.2 Email Notification Setup

Email notification requires that the following fields are properly configured. See **Section 2.4.2** for a description of each field.

Network Tab

- IP Address
- Subnet Mask
- Gateway
- Preferred DNS Server (this is required if Mail Server is entered by name and not by IP address)
- Mail Server (SMTP)
- User Name (If Required)
- Password (If Required)
- Return Email
- Email 1
- Email 2
- Email 3
- Email 4
- Email 5

*Note: WebRelay-10 must be power-cycled (power disconnected, then reconnected) before network settings take effect. Only the settings on the **Network** tab require power-cycling before taking effect.* Email triggers can be generated within a BASIC script (See **Appendix G: BASIC Scripts**), or can be explicitly defined for each relay, input, and sensor under **Relays**, **Inputs**, and **Sensors** tabs.

The email options and recipients for each relay, sensor, or input are configured separately. Select the the Email Option and the checkbox for the desired email recipient for each relay, sensor, or input.

Once the email settings are entered, the email functionality can be tested by entering the following command:

```
http://IP address/state.xml?testEmail=1
```

For example, using the default IP address, enter:

```
http://192.168.1.2/state.xml?testEmail=1
```

This will cause an email message to be sent immediately. If the messages don't get through, the system log file may have some clues to assist in diagnosing the problem (<http://192.168.1.2/syslog.txt>).

Appendix A: Restoring Factory Default Settings

In the event that the IP address or passwords are forgotten, WebRelay-10 may be restored to its original factory default settings.

1. Remove the DC power from the unit. This will also de-energize any relay coils.
2. Use a thin, non-conductive object (such as a toothpick) to press and hold the small button located next to the RJ-45 connector. A tactile feel can be detected as the button is pressed.
CAUTION: DO NOT USE METAL OBJECTS FOR THIS FUNCTION.
3. While depressing the button, apply power and wait for about 10 seconds before releasing the button. All settings will be back to the original factory defaults. log.txt and syslog.txt are retained.
4. Refer to **Section 2.3 Establishing Communications for Setup** to begin reconfiguration of the device.

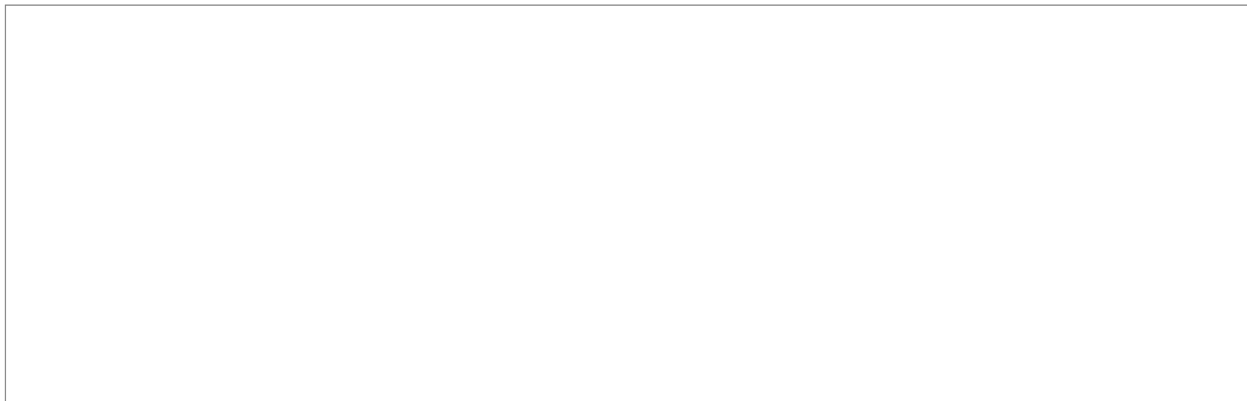

Figure Appendix A.1 - Restore Factory Defaults

Appendix B: Installing New Firmware

From time to time, updates are made to WebRelay-10 firmware. WebRelay-10 firmware can be updated in the field. The procedure for updating the firmware is outlined below. Please note that it is important that this procedure is followed precisely.

Requirements

The firmware update software requires Windows XP/Vista with the .Net framework installed. The .Net framework is generally installed automatically through Windows update. To install it manually, go to the following address:

<http://www.microsoft.com/downloads/details.aspx?FamilyId=333325FD-AE52-4E35-B531-508D977D32A6&displaylang=en>

Select the Download button. Once you've downloaded the installation file, double click on the installation file to install the framework.

Setup

1. Download the bootloader.exe and the new firmware image from the ControlByWeb website under the WebRelay-10 downloads section. Only a WebRelay-10 image can be installed on WebRelay-10 so make sure the correct image is being downloaded.
2. bootloader.exe will connect to the the WebRelay-10 using default IP address 192.168.1.2, not the address currently assigned to the WebRelay-10. After the update, all settings will be lost and the device will return to its default IP address of 192.168.1.2.

Configure the PC to the same subnet as the IP address 192.168.1.2, such as 192.168.1.10. For instructions on doing this see section **2.3 Establishing Communications for Setup**.

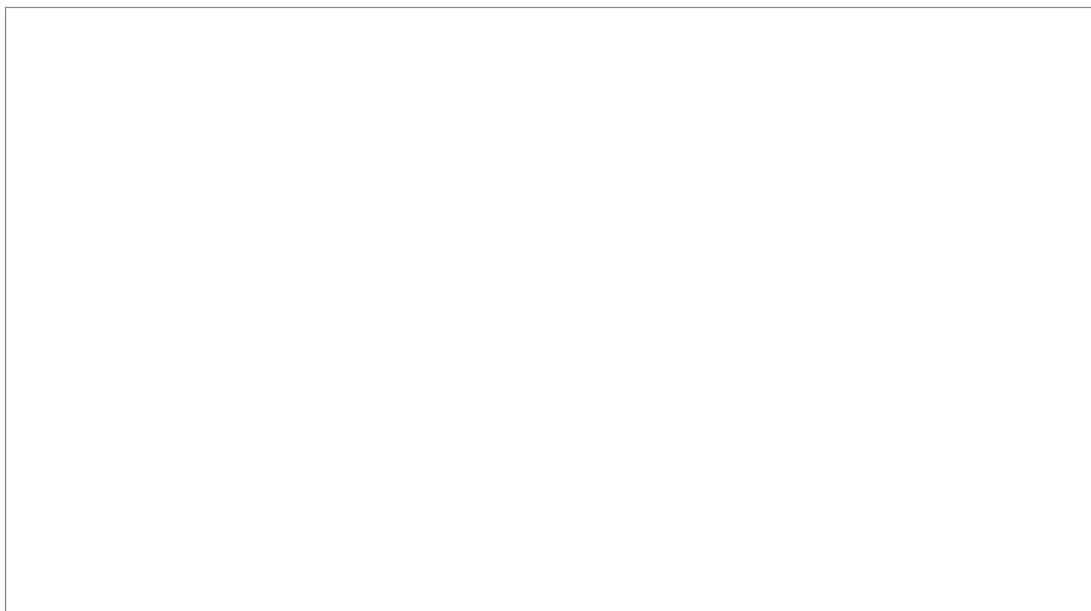

Figure Appendix B.1 - Firmware Update Utility

3. Open the bootloader.exe utility on the computer by double clicking on the downloaded file (Figure Appendix B.1).
4. Within the cbwProgrammer utility programmer, select File, then Open. Specify the firmware image

downloaded from the ControlByWeb™ web site.

Device Upgrade Procedure

Carefully follow the following steps to put the WebRelay-10 into bootloader mode and perform the upgrade:

1. Remove DC power to WebRelay-10.
2. Using a small, non-conductive tool, press and hold the reset button..
3. While holding the reset button, apply power to WebRelay-10. The Link and Act lights will flash. Continue to hold the reset button for the next step.
4. While holding the reset button, press the Upload Firmware button at the bottom of the ControlByWeb™ Programmer window. After the programming process begins, the reset button can be released
5. Programming will take approximately 20-30 seconds, the Link LED will stop flashing and remain lit. WebRelay-10 will be set to factory defaults with an IP address of 192.168.1.2.
6. Refer to section **2.3 Establishing Communication for Setup** to reconfigure the WebRelay-10. Verify the new version of firmware has been installed by viewing the default setup page with a web browser (<http://192.168.1.2/setup.html>).

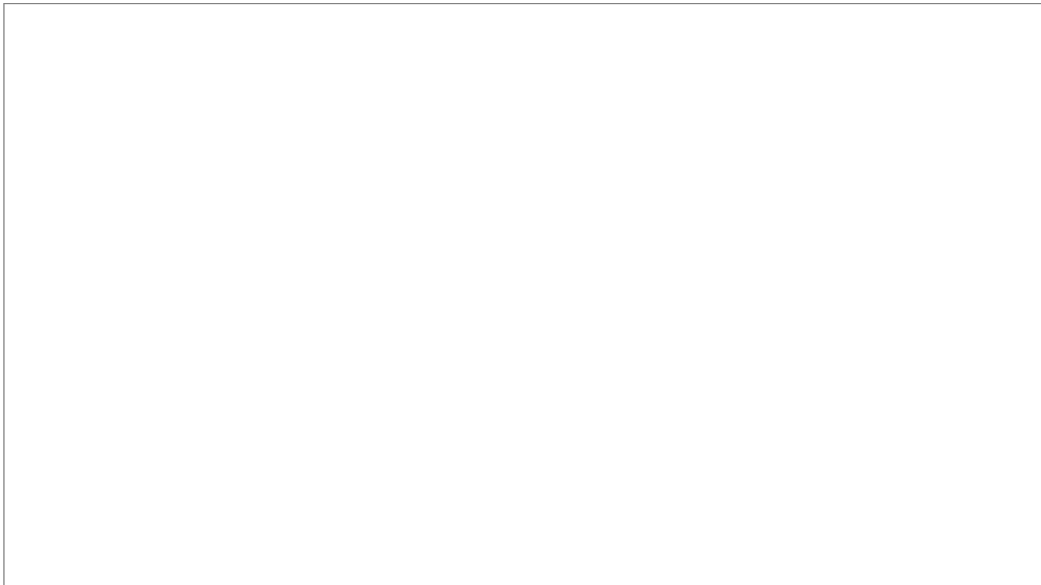

Figure Appendix B.2 - Firmware Update Complete

Appendix C: Accessing WebRelay-10™ Over the Internet

WebRelay-10 can be monitored and/or controlled from a remote location over the Internet. Once WebRelay-10 can be accessed on the local network, almost all of the settings required to provide remote access are in the router and not in WebRelay-10. This guide is not meant to be a tutorial in router setup, but rather to provide a basic overview of remote access. For specific details, the user should refer to the instruction manual for the router on the local network. Users not familiar with basic IP networking should study one or more basic IP networking tutorials before proceeding (many tutorials are available on the Internet).

IP Addresses

Every device on the Internet is identified by a unique address called an IP (Internet Protocol) address. IP addresses are somewhat similar to mailing addresses in that they identify the precise logical location of the device on the Internet. The IP address identifies the global region down to the network and then the specific device on that network. IP addresses are globally maintained and assigned by an entity called the Internet Assigned Numbers Authority (IANA). IP addresses consist of four numbers that range from 0 to 255 and are separated by a decimal. For example, 192.168.200.167 is an IP address.

Every device that is “directly” connected to the Internet uses a “public” IP address. WebRelay-10 can be assigned a public IP address for direct connection to the Internet. Typically, a public IP address would only be assigned to WebRelay-10 when it is the only device on the local network. The IP address would be obtained from an Internet Service Provider (ISP).

Due to the limited number of public IP addresses, private networks can be set up with “private” IP addresses. These addresses are used within a local network and have no global designation, they are not routed on the Internet. The following address blocks are designated for private networks (where x represents decimal numbers from 0 to 255): 192.168.x.x, 10.x.x.x, and 172.16.x.x.

A Simple Local Area Network

A small Local Area Network (LAN), can be made up of two or more computers or other devices connected to an Ethernet switch. Each device on the network is assigned a unique private IP address. For example, consider a simple network that consists of a computer, a WebRelay-10, and a WebRelay™. In this example, the computer is assigned an IP address of 192.168.1.10, WebRelay-10 has the IP address of 192.168.1.25 and a WebRelay™ has an IP address of 192.168.1.26. A person using the computer can access WebRelay-10 by entering its IP address in the URL line in the browser, <http://192.168.1.25>. Similarly, WebRelay™ can be accessed by entering its unique private IP address in the URL line in the browser, <http://192.168.1.26>.

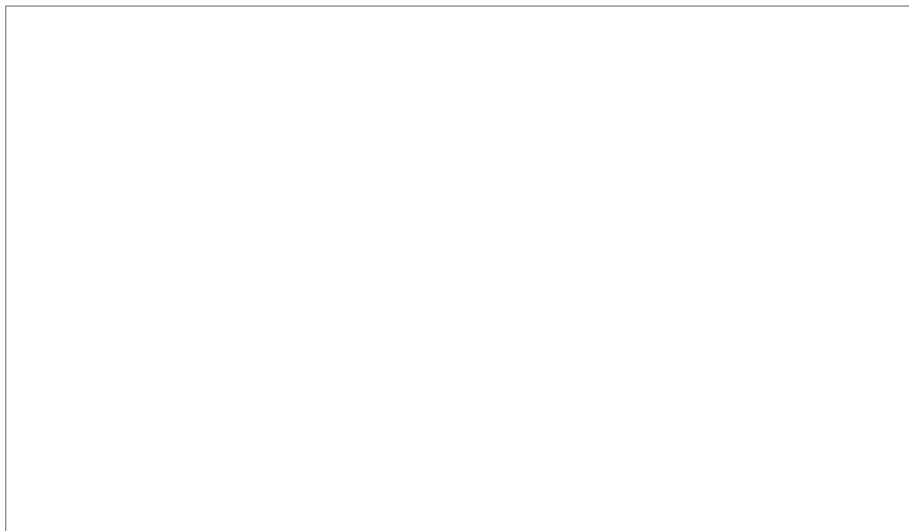

Figure Appendix C.1 - Local Area Network

A Simple LAN connected to the Internet

The LAN in the example above can be connected to the Internet by adding a router and an Internet connection. The router has two network connections. It has an Ethernet network connection to the LAN and another connection to the Internet. Often the Internet connection is called a Wide Area Network (WAN) connection. Each network connection on the router has an IP address. In our example, the IP address on the LAN side of the router has an address of 192.168.1.1. The IP address on the WAN side of the router has an IP address that has been assigned by the Internet Service Provider, such as 266.70.164.97. (This is not a valid IP address because each number cannot be larger than 255 It is used in this example for illustration purposes only.)

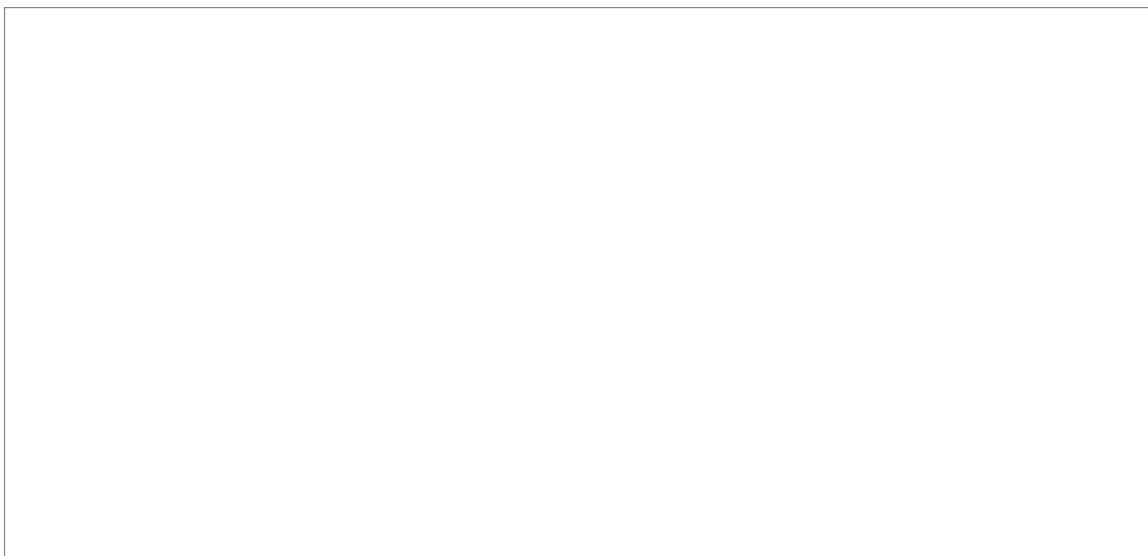

Figure Appendix C.2 - LAN Connected to the Internet

In the example, when a user on the computer needs to access a server on the Internet, the computer sends the request to the router at 192.168.1.1. The router sends the request to the ISP server on the Internet. The ISP server does not send the response directly to the computer on the LAN, but to the router at the IP address of 266.70.164.97. The router then forwards the response to the computer. This

way, all devices on the LAN share a single public IP address. This is called Network Address Translation (NAT).

Port Forwarding

The router can be configured to allow outside access to WebRelay-10 and WebRelay™. All requests from the Internet to any device on the local network must use the public IP address (266.70.164.97). With only a single IP address, TCP ports are used to identify the intended device for the incoming message.

Using the mailing address analogy, the port is similar to a post office box. The IP address specifies the location, and the port specifies the specific recipient. Port numbers can be set to any number between 1 and 65235. However, many port numbers are reserved for specific applications and should be avoided. As a general rule, numbers above 8000 are safe to use. All of the ControlByWeb™ products come from the factory with the HTTP port set to 80, which is the standard port for HTTP. In this example, WebRelay-10 HTTP port will be changed to port 8000 and WebRelay™ port will be changed to 8001. Once the ports are changed in the two ControlByWeb™ devices, the router must be set up for port forwarding.

Port forwarding associates the IP address of each local device with an assigned port. In this example, the address 192.168.1.25 for WebRelay-10 would be associated with port 8000. The address 192.168.1.26 for WebRelay™ would be associated with port 8001. WebRelay-10 would be accessed from the Internet by entering the public IP address of the router, plus the port number assigned to WebRelay-10 in the URL window of the browser, <http://266.70.164.97:8000>. All Internet requests to the router for port 8000 would be forwarded to WebRelay-10. Similarly, all request for port 8001 would be forwarded to WebRelay.

Note: When an HTTP request comes in to the router without the specific port specified (<http://266.70.164.97>), the router will handle this as a port 80 request (default HTTP port). In other words, <http://266.70.164.97> is exactly the same as <http://266.70.164.97:80>.

Router configuration can vary widely. Some routers have the capability of translating the addresses and the ports, which would require no port configuration change on the WebRelay. For example, the router would be configured so that messages sent to <http://266.70.164.97:8000> would be forwarded to <http://266.70.164.97:80>, which is the default HTTP port.

An example screen shot of a router configuration is given below. This setup allows the two ControlByWeb™ products in the above example to be accessed remotely from the Internet.

Note: This screen shot is simply an example of a typical router setup page. Routers will vary.

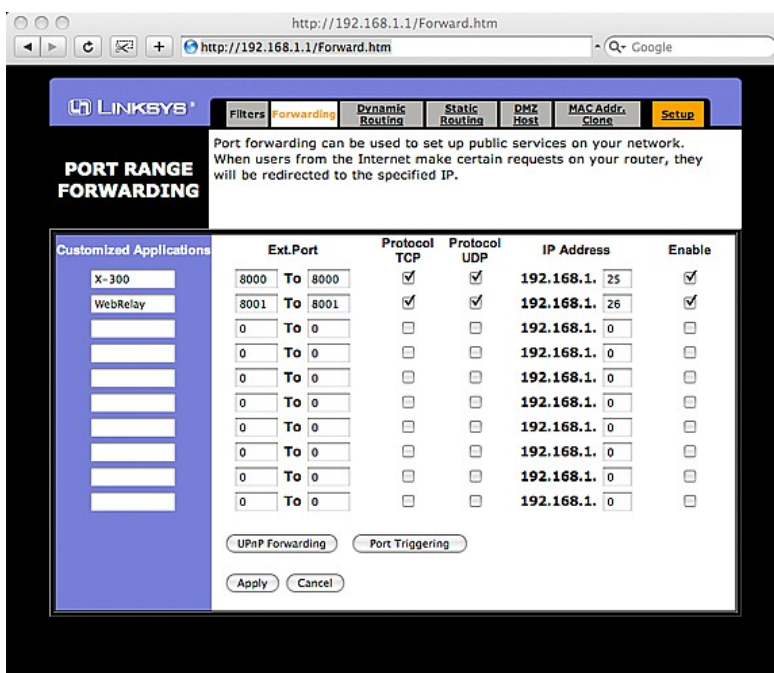

Figure Appendix C.3- Port Range Forwarding

Accessing Setup Pages

After changing ports, the setup pages are accessed on a local network as described below:

```
http://(Local IP Address):(Port Number)/setup.html
```

For example, to access WebRelay-10 at the setup page above, the following command would be used:

```
http://192.168.1.25:8000/setup.html
```

To access the ControlByWeb™ units from the Internet, enter the public IP address of the router plus the port number of the desired device in the following format:

```
http://(Public IP Address of Router):(Port Number of Device)/setup.html
```

Using the example above, the following line would be used to access the setup page of WebRelay-10:

```
http://266.70.164.97:8000/setup.html
```

Appendix D: Log Files (WebRelay-10 Plus™ only)

WebRelay-10 Plus™ logs information to two different log files; log.txt and syslog.txt. Both log files are text files and are stored in nonvolatile memory; this data will not be lost due to power failure and is also not cleared when restoring factory defaults. The log files are stored in circular buffers which write from the beginning of the allocated memory space to the end and then repeat from the beginning (over-writing the original data). The nonvolatile memory is divided into 4K byte sectors. Each time data gets erased to make room for new data, a full sector (4K bytes) is erased at one time.

Data Log File – log.txt

This log file is user-configurable under the **Logging** setup tab, see section **2.4.6 Logging Tab** for more information. and stores real-world data such as temperatures and events such as relay contact changes. It can be up to 512K bytes long and is stored using a comma separated value formatting scheme.

Relays, sensors, and inputs will only be displayed if they are selected in the **Logging** setup tab. The file is read by requesting the log.txt file from WebRelay-10. For example, using the default IP address the following command would be used to request the log file:

```
http://192.168.1.2/log.txt
```

File Format:

```
MM/DD/YYYY HH:MM:SS, Input 1, Input 2, Relay 1, Relay 2, ..., Relay 10, Sensor 1, Sensor 2 ... Sensor 8, Source: State
```

Date and Time Format:

MM – Month (1-12)
 DD – Day (1-31)
 YYYY – Year (1970 - 2106)
 HH – Hour in 24 hour time (0 -23)
 MM – Minutes (0-59)
 SS – Seconds (0-59)

Sample File:

```
Date Time,I1,I2,R1,R2,R3,R4,R5,R6,R7,R8,R9,R10,S1,S2,S3,Source
11/15/2010 11:00:46,0,1,1,1,1,0,1,0,1,0,1,1,078.0,076.4,082.7,Input02:(on)
11/15/2010 11:00:48,0,0,1,1,1,0,1,0,1,0,1,1,078.0,076.4,082.7,Input02:(off)
11/15/2010 11:01:08,0,0,0,0,0,0,1,0,1,0,1,1,078.0,076.5,082.9,Relay03:(off)
11/15/2010 11:02:04,0,0,0,0,0,1,1,0,1,0,1,1,077.7,076.4,083.4,Relay04:(on)
11/15/2010 11:05:00,0,0,0,0,0,1,1,0,1,0,1,1,077.7,076.4,083.4,XmlReq:(192.168.1.29 R)
11/15/2010 11:20:54,1,0,0,0,0,1,1,0,1,0,1,1,077.7,076.4,083.4,XmlReq:(192.168.1.29 W)
```

The file can then be saved using the 'Save As...' option under the 'File' menu of the web browser. If the TCP port has been changed (not port 80), the port will be required to read the file. For example, using the default IP address, and port 8000, the log file would be read as follows:

```
http://192.168.1.2:8000/log.txt
```

The log.txt file may be erased with the following command:

```
http://192.168.1.2/log.txt?erase=1
```

After erasing the file, it might be necessary to refresh the page.

Note: If the Control Password is enabled in the setup pages, the password will be required to access the log file.

System Log File – syslog.txt

The systole file records various system events, which can be used for diagnostics and troubleshooting purposes.

File Format:

MM/DD/YYYY HH:MM:SS, (category to which message applies): (message)

Sample File:

01/02/2010 04:08:13 DEVICE: Power Up.
01/01/2010 00:41:05 DEVICE: Reset factory defaults.

Listed below is a description of messages that a user may see:

Category	Message	Description
DEVICE	Power Up	Device has been properly powered.
	Initialize	Device is ready.
	Reset Factory Defaults	Device has been reset to factory defaults.
EMAIL	Failed DNS Lookup	Unable to lookup mail server due to an incorrect DNS setting.
	Bad Username	Email was not sent due to an incorrect user name.
	Bad Password	Email was not sent due to an incorrect password.
	Authentication Required	A user name and password are required by the mail server.
	No Response	No response from SMTP server.
CLOCK	RTC Reset	Real Time Clock has been reset.
NTP SERVER	Request Attempt	Device attempting to connect to NTP Server
	Failed DNS Lookup	Unable to lookup NTP server name due to an incorrect DNS setting.
	Success	Device successfully connected to NTP Server.
REMOTE SERVER	Failed DNS Lookup	Unable to lookup Remote Server due to an incorrect DNS setting.
	Connection Attempt Started	Connection port with Remote Server has ben opened.
	Connection Closed	Connection port with the Remote Server has been closed.
DHCP	Address Acquired	IP address request successful, and IP address assigned.
	Lease Renewal	IP address assigned to device was renewed.
MAIN_MCU	New Firmware Loaded	New firmware has been loaded to the device.

This file is read by requesting the syslog.txt file. For example, using the default IP address the following command would be used:

```
http://192.168.1.2/syslog.txt
```

Note: The setup user name and password are required to access this file.

If the TCP port has been changed (not port 80), the port will be required to read the file. For example, using the default IP address, and port 8000, the log file would be read as follows:

```
http://192.168.1.2:8000/syslog.txt
```

To erase the file, use:

```
http://192.168.1.2/syslog.txt?erase=1
```

Appendix E: External Server and Remote Services

Note: The following methods are supported by WebRelay-10; however, Xytronix Research & Design, Inc. does not provide or support custom third party applications, or external web servers.

Accessing WebRelay-10 with Custom Software or Third Party Applications

Custom applications can send commands to WebRelay-10 for monitoring and control. The application interface can be used to provide a custom user interface, access to multiple units in a single screen, and allow for automation, logging, and other application-specific features.

Using an External Web Server

Rather than accessing WebRelay-10 directly from a computer, an external web server can be used. The term “external” web server is used here to mean a separate web server (such as Apache or IIS) that is not the web server built into WebRelay-10. In this scenario, users access custom web pages that reside on the external web server and the external web server communicates with WebRelay-10.

An external web server can integrate multiple ControlByWeb products into a single control page. In other words, the user may not be aware that he/she is using multiple ControlByWeb™ devices, but rather the user sees an integrated control page for the entire system. In addition, the use of an external web server allows programmers to create custom user interfaces that take advantage of the additional resources typically available on larger web servers, including more memory and various web programming languages.

There are two approaches that an external server can use to communicate with WebRelay-10 and other ControlByWeb™ devices, Direct Server Control and Remote Services.

Direct Server Control

The first approach is for the external server to create a TCP connection whenever it needs to access WebRelay-10. In this case, the external server opens the connection, sends commands and/or reads the device, and closes the connection.

This method is ideal when the the web server and all of WebRelay-10 devices are on the same network (without routers between them). In this case, the server can communicate with WebRelay-10 devices directly and securely since data never has to leave the local network.

When the server and WebRelay-10 are on different networks, routers must be configured to allow appropriate access. If a public network is used, such as the Internet, security precautions should be considered.

Remote Services

The second approach is for WebRelay-10 to initiate a connection using the “Remote Services.” The settings under the **Advanced Network** tab in the setup pages will enable the WebRelay-10™ to open a TCP connection with an external server. Once the connection is open, the external server can send commands and/or read the device. The external server can leave the connection open (so that it never closes) or close the connection.

“Remote Services” is ideal for installations where the server and WebRelay-10 are installed on different networks. This is especially useful when each

WebRelay-10 is installed on a separate private network. For example, if the user doesn't control the network connections where WebRelay-10 is installed, “Remote Services” would initiate a TCP connection over the Internet with the control computer. Since WebRelay-10 initiates the connection, the control computer doesn't have to know the IP address of WebRelay-10. This means that WebRelay-10 can be installed using DHCP. In addition, no special router configuration is required. This makes the

network installation of WebRelay-10 very simple, and since no incoming ports need to be opened in the router, security is not compromised. See section **2.4.3 Advanced Network Tab** for more information.

WebRelay-10 can be configured to establish a connection when triggered by an event, such as a relay state changing. This is done by setting the Remote Service/SNMP checkbox in the relay and input setup tabs.

Connection String

With Remote Services enabled, a connection attempt will be made periodically according to the Connection Interval setting in the **Advanced Network** setup tab. The Connection String is a user-defined character string configured in the **Advanced Network** tab.

The connection string is also sent at the same interval once the connection is open. The external server is responsible for closing the connection when it is done.

Remote Commands

Once the connection is open, the remote server can issue HTTP GET requests to the device for XML files.

Request about.html:

```
GET /about.html HTTP/1.1\r\n\r\n
```

Turn Relay 1 ON:

```
GET /state.xml?relay1State=1 HTTP/1.1\r\n\r\n
```

Events:

When an event occurs and a connection is open, the state.xml file is be sent.

If a connection is not open and Remote Services is enabled, a connection will be established by sending the connection string. Once the connection is established state.xml will be sent.

Appendix F: SNMP Requests, Objects and Community Strings

Relay states, input states, some simple network parameters, and temperature/humidity measured by WebRelay-10 can be retrieved using Simple Network Management Protocol (SNMP). The states of the relays can be changed through SNMP requests. For most cases, using SNMP is as simple as locating the appropriate Management Information Bases (MIB) files and loading them into the SNMP manager software. WebRelay-10 can make use of the following MIB files: RFC1213-MIB and XYTRONIX_V1_0.mib.

Note: As additional ControlByWeb products are introduced, the Xytronix MIB file will remain reverse compatible, older MIB files can be overwritten.

SNMP is configured under the **Advanced Network** setup tab. See section **2.3.3 Advanced Network Tab** for more information.

WebRelay-10 supports the following Packet Data Units (PDU):

- GetRequest
- GetNextRequest
- SetRequest
- Trap

Standard Objects

WebRelay-10 supports several standard RFC1213 objects that usually come with SNMP management software. If not, an Internet search for RFC1213-MIB will turn up multiple links.

RFC1213 Object	Response
<code>system.sysDescr</code>	Device description: X-10 - Event Scheduler/10 Relay Controller
<code>system.sysObjectID</code>	Object identifier (OID): .1.3.6.1.4.1.30586.13
<code>system.sysUpTime</code>	Time in hundredths of seconds since WebRelay-10 was last powered.
<code>system.sysName</code>	Device name: WebRelay-10

Xytronix Objects

WebRelay-10 also supports some special objects that can be found in the XYTRONIX.mib. This MIB can be downloaded from our website.

Relays – Read/Write

A Get request will return the current state. A Set request of 0 or 1 will turn the relay **ON** or **OFF**. A Set request of 2 will pulse the relay for the time configured in the setup page.

Object	Response	Set Value
web10.webrelay_ten_relayOne.0	Value: 0 or 1	0 – OFF, 1 – ON, 2 – Pulse
web10.webrelay_ten_sensorTwo.0	Value: 0 or 1	0 – OFF, 1 – ON, 2 – Pulse
web10.webrelay_ten_relayThree.0	Value: 0 or 1	0 – OFF, 1 – ON, 2 – Pulse
web10.webrelay_ten_relayFour.0	Value: 0 or 1	0 – OFF, 1 – ON, 2 – Pulse
web10.webrelay_ten_relayFive.0	Value: 0 or 1	0 – OFF, 1 – ON, 2 – Pulse
web10.webrelay_ten_relaySix.0	Value: 0 or 1	0 – OFF, 1 – ON, 2 – Pulse
web10.webrelay_ten_relaySeven.0	Value: 0 or 1	0 – OFF, 1 – ON, 2 – Pulse
web10.webrelay_ten_relayEight.0	Value: 0 or 1	0 – OFF, 1 – ON, 2 – Pulse
web10.webrelay_ten_relayNine.0	Value: 0 or 1	0 – OFF, 1 – ON, 2 – Pulse
web10.webrelay_ten_relayTen.0	Value: 0 or 1	0 – OFF, 1 – ON, 2 – Pulse

WebRelay-10 Plus™ Inputs

Object	Response
web10.webrelay_ten_inputOne.0	Value: 0 or 1 (0 – OFF, 1 – ON)
web10.webrelay_ten_inputTwo.0	Value: 0 or 1

WebRelay-10 Plus™ Sensors

Object	Response
web10.webrelay_ten_sensorOne.0	Value: x.x (Decimal temperature or humidity.)
web10.webrelay_ten_sensorTwo.0	Value: x.x (Decimal temperature or humidity.)

TRAPS

WebRelay-10 can send SNMP messages when a relay or input changes state or when a particular sensor value is reached. The SNMP Trap must be configured for each sensor, input, or relay in the setup pages. The following Traps are supported:

Relay Traps

A change in state of the relay will cause the WebRelay-10 to send a Trap message.

Object	Description	Value
web10.75	Relay one state change.	0 or 1 (0 – OFF, 1 – ON)
web10.76 to 84	Relay xxxx state change.	0 or 1

Input Traps (WebRelay-10 Plus™ only)

When an input on the WebRelay-10 Plus™ changes state, a Trap message will be sent.

Object	Description	Value
web10.95	Input one state change.	0 or 1 (0 – OFF, 1 – ON)
web10.96	Input two state change.	0 or 1

Sensor Traps (WebRelay-10 Plus™ only)

Two alarm thresholds can be configured for each sensor. An SNMP Trap messages can be sent when

the temperature boundaries are crossed. See **2.3.9 Sensor Tab** for more information on configuring the sensor alarms.

Object	Description	Value
web10.65	Sensor one alarm.	x.x (Decimal temperature or humidity.)
web10.66	Sensor two alarm.	x.x (Decimal temperature or humidity.)
Web10.67	Sensor three alarm.	x.x (Decimal temperature or humidity.)
Web10.68	Sensor four alarm.	x.x (Decimal temperature or humidity.)
Web10.69	Sensor five alarm.	x.x (Decimal temperature or humidity.)
Web10.70	Sensor six alarm.	x.x (Decimal temperature or humidity.)
Web10.71	Sensor seven alarm.	x.x (Decimal temperature or humidity.)
Web10.72	Sensor eight alarm.	x.x (Decimal temperature or humidity.)

Password

WebRelay-10 uses the Control Password for both the read and write community strings. If the Control Password is disabled, any object can be read without the need for a correct community string. By default the Control Password is `webrelay`.

Appendix G: BASIC Scripts

BASIC (Beginners All-purpose Symbolic Instruction Code) is a computer programming language that has been in use for many years. The WebRelay-10 has an integrated BASIC interpreter for simple BASIC scripts. This provides a great deal of flexibility by allowing users to customize basic functions of the unit. The interpreter only supports a small subset of the BASIC commands that are available for computers. Some non-standard commands have been added, and some commands may function differently on the WebRelay-10 BASIC interpreter than on other platforms. The following is a short tutorial on the supported BASIC functions.

Contact customer support if further assistance is required.

Structure

A BASIC script is written as a .txt file, which is then uploaded to the device using the **Script** setup tab. The

maximum script size is 2K bytes. Each line within the script contains a single statement. Line numbers are not used. Statements are not case sensitive; however, variables are.

IF THEN, FOR loops, and DO loops can only be nested up to 5 times per command. For those not familiar with nesting, the following is an example of nested FOR loops:

```
FOR a = 0 to 100
  FOR b = 0 to 100
    NEXT b
  NEXT a
```

Every program must end with an END statement. Subroutines would then follow after the END statement, if required. The last line of the script should be left blank.

Line Format

Every line follows the same format. The basic format is:

statement (variable) (=, <, >, <=, >=, <>) (expression) (THEN)

The fields in parentheses are optional depending on the statement. Spaces must be used between all statements, numbers, variables, operators, expressions, etc. Multiple spaces are valid.

Comments may be inserted, but must begin with an apostrophe. All text on a line after the apostrophe is ignored.

Examples:

```
LET a=1           'this will return an error because of insufficient spacing
LET a = 1        'this is valid
LET a = 1        'this is valid
```

Only a single variable or literal is allowed on the left side of any operator. The following example is incorrect and

will return an error. The error occurs because there is more than a single value to the left of the comparison operator (a + 2 is to the left of =).

```
IF a + 2 = 3 THEN 'this will return an error
```

To fix the above line, replace 'a + 2.' One of the following options may be used:

```
IF a = 1 THEN
...Or...
LET b = a + 2
IF b = 3 THEN
```

Supported Statements

The following are the statements supported by the ControlByWeb™ BASIC interpreter.

LET

The LET statement assigns a variable a value. The format is:

LET (variable) = (expression)

IF THEN, ELSE, END IF

The IF THEN statement tests the truth of a condition. The ELSE statement defines a second function if the condition is found false. In other words, if the condition is true, then a function is performed. If it is not true, a second function may be performed. The second function may or may not be necessary depending on the application. The IF THEN (ELSE) statement must always be followed with an END IF statement. The format is:

*IF (variable) (=, <, >, <=, >=, <>) (expression) THEN
(Function 1)
ELSE
(Function 2)
END IF*

Note: In most BASIC interpreters, 'Function 1' (see above) may be placed after the THEN statement. This interpreter requires 'Function 1' to be put on the following line.

FOR TO, NEXT

The FOR TO statement loops a section of code a predefined number of times. The NEXT statement always follows the section of code to be looped. The format is:

*FOR (variable) = (expression) TO (expression)
(code to be looped)
NEXT (variable)*

DO WHILE, LOOP

The DO WHILE statement loops a section of code while a condition is found true. The LOOP statement always follows the section of code to be looped. Note that if the condition is omitted, the code will be looped without end. The format is:

*DO WHILE (variable) (=, <, >, <=, >=, <>) (expression)
(code to be looped)
LOOP*

LOG

The LOG statement causes the device to log data according to the settings specified under the **Logging** setup tab.

*Note: In order to log, logging must be enabled in the **Logging** setup tab.*

The format is: LOG

EMAIL

The EMAIL statement causes the device to send an email of the same format as that generated by other status change and alarm conditions. The event that triggered the email is given, followed by the input and relay states. The format is:

EMAIL (feature state – relayX, inputX, tempX) 'X represents the feature number such as relay9
Examples:

```

EMAIL          'Status email sent to addresses listed under Network tab.
...Or...
EMAIL relay2   'Sends state change message to emails setup in Relays tab.
...Or...
EMAIL input1  'Input state change message to emails setup in Input tab.
...Or...
EMAIL temp2   'Temp alarm message sent to recipients in the Sensors tab.

```

END

The END statement ends the main body of code.

CALL

The CALL statement is found within the main body of code, but requires the interpreter to skip to a subroutine found at the end of the program. After the subroutine is finished, the interpreter returns to the line immediately following the CALL statement. The format is:

```
CALL (name of subroutine)
```

SUB, END SUB

The SUB statement defines the beginning and name of a subroutine. The END SUB statement defines the end of the respective subroutine. Subroutine names can be up to 20 characters long and are case sensitive. The SUB and END SUB statements always must follow the END statement. The format is:

```

END

*** Subroutines Go Here ***
SUB (name of subroutine)
  (contents of subroutine)
END SUB
SUB (name of subroutine)
  (contents of subroutine)
END SUB

```

REM or '

The REM or apostrophe (') statement designates remarks made by the programmer. The interpreter will disregard any characters on the line following these statements.

PRINT

The PRINT statement relays a variable or message to the display. The PRINT statement is only available for the PC version of the BASIC interpreter. The device will not recognize the command since it does not have an operator display. The format is:

```

PRINT (variable)      'relay variable value to screen
PRINT "(message)"    'relay '(message)' to screen

```

User-Defined Variables

Two types of variables are available for use in the ControlByWeb™ BASIC interpreter, user-defined variables, and predefined variables.

Up to 10 user-defined variables are allowed to be used in scripts. Variables are represented by single, lower-case characters ranging from the letter 'a' to the letter 'j'. They are always global and stored internally as floating point numbers. Variables are defined using the LET statement.

Examples:

```
Let b = 5           'variable b will be set to 5
Let d = b + 2      'variable d will be set to 7
```

Predefined Variables

The following are useful predefined variables for the ControlByWeb™ BASIC interpreter. These are useful for accessing internal values and features states.

Note: Some models may not contain digital inputs, analog inputs and/or relays and thus would not have digital input, analog input and/or relay variables.

Timer Variables

Six timers are available for use in BASIC scripts. They are designated as t0 through t5. Timers can be set to any positive integer (or 0) by using the LET statement. As soon as a value is assigned to a timer, it will begin to count down immediately by decrementing one count every 100ms until it reaches zero.

Examples:

```
Let t3 = 1500      'set timer 3 to 150 seconds
Let t1 = 0         'disable time 1
```

Relay Variables

The relays can be turned **ON**, turned **OFF**, pulsed, toggled, or read in BASIC scripts. The LET statement is used to set the relay state. The state options available are:

- 0 – turn relay off
- 1 – turn relay on
- 2 – pulse relay
- 5 – toggle relay

The pulse time is specified in the **Relays** setup tab. Relays are designated as relay1, relay2, etc., which correspond to Relay 1, Relay 2, etc.

Examples:

```
Let relay1 = 1     'turn on relay 1
Let relay2 = 0     'turn off relay 2
Let relay1 = 2     'pulse relay 1
Let relay2 = 5     'toggle relay 2
Let a = relay2     'read the state of relay 2, state will be 0 or 1
```

Input Variables (WebRelay-10 Plus™ only)

The input states can be read in BASIC scripts. The inputs are designated as input1 and input2.

Example:

```
Let a = input1    'sets 'a' equal to value of input 1
```

Temperature/Humidity Sensor Variables (WebRelay-10 Plus™ only)

Each temperature sensor or humidity sensor can be read in BASIC scripts. The sensors are designated as temp1, temp2 ... temp8

Example:

```
If temp2 >= 80 Then 'If temperature sensor reads greater than 80
                    ' degrees, then
    Let relay2 = 1   'Turn on relay 2
End If
```

Date and Time Variables (WebRelay-10 Plus™ only)

The variables 'time' and 'date' are predefined, read only variables that store the current date and time. They can be used to schedule events and activities, such as sending emails, reading temperature, or setting relays. The date uses the mm/dd/yyyy format. Clock time is formatted as hh:mm:ss (24-hour clock).

Example:

```
If date = 01/01/2014 Then
  If time > 12:30:00 Then
    Let relay2 = 1
    Let relay3 = 0
  End If
End If
```

*Note: Current date and time can only be set in the **Date/Time** tab.*

Event Variables (WebRelay-10 Plus™ only)

Up to five actions can be configured to occur at specified days and times. This is done by setting the day and time of the event and then comparing it to the current date and time.

The event date variables are designated ed1 to ed5. They are set using the LET command and setting the desired event date variable equal to the date the event should occur in the format mm/dd/yyyy. The event date variables store the number of days that have passed since January 1, 1970.

The event time variables are designated et1 to et5. They are likewise set using the LET command and setting the corresponding event time variable equal to the event time in the format hh:mm:ss in 24-hour time. The event time variables store the number of seconds from the beginning of the day. If the event time variable is incremented more than the number of seconds in a day (86400 seconds), the variable is reset to 0 and the event date variable is incremented by one.

The following example demonstrates defining the event variables and comparing it to the current date and time. Assume current time is April 10, 2010 at 1:30 AM and the event should occur in one hour and every hour thereafter.

Example:

```
Let a = 1
Let ed1 = 04/10/2010           'sets the event date to April 10,
                               '2010.
Let et1 = 02:30:00           'sets the event time to 2:30
Do While a <> 0
  If ed1 >= date Then         'Tests event date versus current date.
    If et1 >= time Then       'Tests event time versus current time.
      Let et1 = et1 + 3600    'Increments the event time by one hour
                              '(in seconds).
      Print "Event"          'Event to occur
    End If
  End If
Loop
End
```

External Variables

There are five external variables, extvar0 through extvar4. External variables are similar to general purpose variables and can be used in the same manner. The difference between general purpose variables and external variables is that external variables can be accessed by the user through a web browser and modified while the script is running. Scripts can use external variables as a method of retrieving user input. The following example demonstrates this by creating a script that will turn Relay 1 **ON** if extvar1 equals 1 and turn Relay 1 **OFF** if extvar1 equals 0.

Example:

```
Do
  If extvar1 = 1 Then
    Let relay1 = 1
  Else
    Let relay1 = 0
  End If
Loop
End
```

Extvar1 can be set and cleared by entering the following requests into a web browser or by configuring on and off buttons to appear on the **Control Page** for extvar0:

```
http://192.168.1.2/state.xml?extvar1=1
http://192.168.1.2/state.xml?extvar1=0
```

Testing and Debugging

A copy of the BASIC interpreter for Windows is also available on our website for the use of testing and debugging. The WebRelay-10 will only acknowledge errors as it runs. This means that if a path of the script is not encountered, errors may still exist. The Windows version of the interpreter, however, will check for errors before the script is run.

The PRINT function is available for use with the Windows version of the BASIC interpreter. The interpreter on the device, however, will not recognize this command.

Note: The script will be restarted by submitting any of the setup pages or by power cycling the unit.

Appendix H: Specifications

Power Requirements

Input Voltage: 9-28 VDC

Current: See table below for typical values at 25°C.

10 Mbps Network Speed

Power Supply	No Relays Energized	5 Relays Energized	10 Relays Energized
9 VDC	114 mA	692 mA	1320 mA
12 VDC	86 mA	516 mA	959 mA
24 VDC	46 mA	264 mA	477 mA

100 Mbps Network Speed

Power Supply	No Relays Energized	5 Relays Energized	10 Relays Energized
9 VDC	200 mA	779 mA	1391 mA
12 VDC	151 mA	580 mA	1036 mA
24 VDC	80 mA	295 mA	511 mA

I/O

- 10 Relays
- 2 Inputs (WebRelay-10 Plus™ only)
- Up to 8 Temperature and/or Humidity Sensors (WebRelay-10 Plus™ only)

Relay Contacts

Load Type:	General purpose
Contact Form:	SPDT (form C)
Contact Material:	Silver Nickel
Max Voltage:	277 VAC (general purpose); 30 VDC (NC contact, resistive)
Recommended Max Current:	15A
Absolute Max Current:	40A
Contact Resistance:	<30 milliohms initial
Electrical Life:	100K cycles, typical @ full-rated load (higher w/ smaller load)
Mechanical Life:	10M cycles, typical
Relay Compliance:	UL/CUL listed relays (E197852)

Relay and Power Input Connections

Tab Terminals:	1/4" x .032"
	Use UL listed quick-connect connectors suitable for field connections. Use crimping tool as specified by the connector manufacturer.
Wire	Use wire rated for 75°C (min) for connections to the relays.

Environmental

Operating Temperature:	-40°C to 65.5°C (-40°F to 150°F)
Storage Temperature:	-40°C to 85°C (-40°F to 185°F)
Humidity:	5% to 95% non condensing
Altitude:	Up to 2,000 meters
Environmental Rating:	Pollution Degree 2
Installation:	Must be installed inside an NRTL certified industrial control panel or similar NRTL certified fire/electrical enclosure.

Accessory Connector (WebRelay-10 Plus™ only)

5-position, removable terminal strip, 3.81 mm terminal spacing
(Replacement part number, Phoenix Contact 1803604)

Inputs (WebRelay-10 Plus™ only)

Number of Inputs: 2
Input Type: Discrete Inputs (connect to dry contacts)
Maximum Input Voltage: 5 VDC
Minimum Hold Time (high or low): 20ms

Counters (WebRelay-10 Plus™ only)

Number of counters: 2
Counter Triggers: Input transitions - low to high, high to low, or both
Maximum Count: 4000000000
Maximum Count Frequency: 25Hz

Temperature Sensors (WebRelay-10 Plus™ only)

"1-Wire" Digital Thermometer (Dallas Semiconductor part DS18B20)
Temperature Range: -20°C to 40°C (-4°F to 104°F)
Accuracy: 0.5 from -10°C to +85°C
Maximum number of sensors: 8
Maximum Distance from WebRelay-10 to sensors: Combined cable length of 600 ft using Cat 5e

Additional Sensors (WebRelay-10 Plus™ only)

- Temperature/Humidity Sensor (X-DTHS-WM)
- Humidity Sensor: 0-100% RH
- Accuracy: ±1.8%

Network

10 Base-T or 100 Base-T Ethernet IPv4
Setup: Static IP address assignment or DHCP, HTTP port selectable
Network Connector: 8-pin RJ-45 socket

13 LED Indicators

Power On
Relay Coils Energized (1-10)
Network Linked
Network Activity

Real-Time Clock (WebRelay-10 Plus™ only)

Manual or NTP (Network Time Protocol) setup
NTP Sync Period: Once, Daily, Weekly, On Power-up
Automatic Daylight Savings Adjustment
Battery (capacitor) Power Backup

Capacitor Power Backup (WebRelay-10 Plus™ only)

Backup Functions: Retain Real-Time Clock, External Variables, Relay State
Backup Duration: 3 days minimum

Nonvolatile Memory

- Memory Type: Flash
- Function: All user settings are stored in nonvolatile memory. Settings will not be lost when power is disconnected.

Physical

- Operating Temperature: -40°C to 65.5°C (-40°F to 150°F)
- Size: 9.125in (232mm) wide, 2.423in (62mm) tall, 4.25in (126mm) deep
- Weight: 22 oz. (626 grams)

Monitor/Control

- Web Browser, XML, Modbus/TCP, SNMP

Logging (WebRelay-10 Plus™ only)

- Storage: Nonvolatile Flash
- Buffer Architecture: Circular Buffer
- Log File Size: 512K (max 17900 logs)
- Unlimited data storage from Web Monitoring Service

Password Settings

- Password protection on setup page: Yes
- Password protection on **Control Page**: Optional
- Password Encoding: Base 64
- Max password length: 13 character

Electromagnetic Compliance

IEC CISPR 22, CISPR 24
FCC 47CFR15 (Class B)
EN55024 ITE Immunity (2010)
EN55022 Emissions (2010)



Appendix I: Warranty

This Xytronix Research & Design, Inc. product is warranted against defects in material and workmanship for a period of five years from the date of shipment for products purchased on or after May 1, 2016 (one year for products purchased before May 1, 2016). During the warranty period, Xytronix Research & Design, Inc. will, at its option, either repair or replace products that prove to be defective. This warranty is extended to the original purchaser of the equipment only.

For warranty service or repair, customer must contact Xytronix Research & Design, Inc. technical support (support@ControlByWeb.com) and obtain a Return Authorization number (RA#). Before issuing an RA#, a support technician will work with customer to try to resolve the issue without returning the product. If technician determines that product must be returned for service an RA# will be issued. Next, the product must be properly packaged and returned to Xytronix Research & Design, Inc. with the RA# clearly marked on the package. The purchaser shall prepay all charges for shipping to Xytronix Research & Design, Inc. For warranty repairs of products less than one year old, Xytronix Research & Design, Inc. will pay the shipping charges to return the product to the purchaser as long as the product is shipped within the continental United States. If the product is shipped outside of the continental United States or the product was shipped more than one year earlier, the purchaser shall pay all shipping charges, duties, and taxes.

Limitation

The foregoing warranty shall not apply to defects or damage resulting from improper use or misuse, unauthorized repair, tampering, modification, improper connection, or operation outside the electrical/environmental specifications for the product. Further, the warranty does not cover Acts of God, such as fire, flood, hurricanes, and tornadoes. This warranty does not cover damage to property, equipment, direct, indirect, consequential, or incidental damage (including damage for loss of business profit, business interruption, loss of data, and the like) arising out of the use or misuse of this product.

UNDER NO CIRCUMSTANCES WILL THE LIABILITY OF XYTRONIX RESEARCH & DESIGN, INC. TO THE PURCHASER OR ANY OTHER PARTY EXCEED THE ORIGINAL PURCHASE PRICE OF THE PRODUCT, REGARDLESS OF THE FORM OF THE CLAIM. No other warranty is expressed or implied. Xytronix Research & Design, Inc. specifically disclaims the implied warranties of merchantability and fitness for a particular purpose. Some jurisdictions may not allow the exclusion of limitation of liability for consequential or incidental damage.

Appendix J: FCC Statement

This device complies with Part 15 of the FCC Rules. Operation is subject to the following two conditions:

- This device may not cause harmful interference.
- This device must accept any interference received, including interference that may cause undesired operation.

Warning

This equipment has been tested and found to comply with the limits for a Class B digital device, pursuant to Part 15 of the FCC Rules. These limits are designed to provide reasonable protection. This equipment generates, uses and can radiate radio frequency energy and, if not installed and used in accordance with the instructions, may cause interference to radio communications. There is no guarantee, however, that interference will not occur in a particular installation. If this equipment does cause harmful interference to radio or television reception, which can be determined by turning the equipment off and on, the user is encouraged to try to correct the interference by one or more of the following measures:

- Reorient or relocate the receiving antenna.
- Increase the separation between the equipment and receiver.
- Connect the equipment into a relay on a circuit different from where the receiver is connected.
- Consult the dealer or an experienced radio/TV technician for help.

Notice

Changes or modification not expressly approved by the party responsible for compliance could void the user's authority to operate the equipment.

Appendix K: Trademark and Copyright Information

- This document is Copyright ©2005-2015 by Xytronix Research & Design, Inc. All rights reserved.
- WebRelay-10™, WebRelay™, ControlByWeb™, and Xytronix Research & Design™ are trademarks of Xytronix Research & Design™, Inc. 2005-2015.
- All other trademarks are the property of their respective owners.
- All parts of this product and design including but not limited to firmware, hardware design, schematics, PCB layout, concept, graphics, users manual, etc., are property of Xytronix Research & Design, Inc. ©2005-2015. WebRelay-10™ may not be opened, disassembled, copied or reverse-engineered.
- No part of this manual may be reproduced or transmitted in any form or by any means, electronic or mechanical, including photocopying or scanning, for any purpose other than the personal use by the purchaser of this product. Xytronix Research & Design, Inc., assumes no responsibility for any errors that may appear in this document.
- Whereas reasonable effort has been made to make the information in this document as useful and accurate as possible, Xytronix Research & Design, Inc. assumes no responsibility for the application, usefulness, or completeness of the information contained herein. Under no circumstance will Xytronix Research & Design, Inc. be responsible or liable for any damages or losses including direct, indirect, special, incidental, or consequential damages or losses arising from either the use of any information contained within this manual or the use of any products or services referenced in this manual.
- Xytronix Research & Design, Inc. reserves the right to change any product's features, specifications, documentation, warranties, fee schedules, and conditions at any time and without notice.

Appendix L: Mechanical Information

