

User Guide
6641-22810

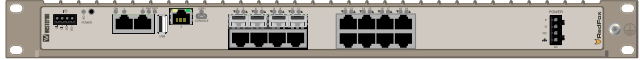

RedFox Industrial Rack S E R I E S



Industrial Routing Switch

www.westermo.com



Software tools

Related software tools are available in the folder software tools under technical support on the Westermo website.

License Information

This device contains public available software which is under the GPL license. For more information see [legal.pdf](#) included with all firmware releases.

This product includes software developed by the OpenSSL Project for use in the OpenSSL Toolkit. <http://www.openssl.org>

Legal information

The contents of this document are provided "as is". Except as required by applicable law, no warranties of any kind, either express or implied, including, but not limited to, the implied warranties of merchantability and fitness for a particular purpose, are made in relation to the accuracy and reliability or contents of this document. Westermo reserves the right to revise this document or withdraw it at any time without prior notice.

Under no circumstances shall Westermo be responsible for any loss of data or income or any special, incidental, and consequential or indirect damages howsoever caused. More information about Westermo can be found at the following Internet address:

<http://www.westermo.com>

Safety



Before installation:

Read this manual completely and gather all information on the unit. Make sure that you understand it fully. Check that your application does not exceed the safe operating specifications for this unit.

This unit should only be installed by qualified personnel.

This unit should be built-in to an apparatus cabinet, or similar, where access is restricted to service personnel only.

The power supply wiring must be sufficiently fused, and if necessary it must be possible to disconnect manually from the power supply. Ensure compliance to national installation regulations.

This unit uses convection cooling. To avoid obstructing the airflow around the unit, follow the spacing recommendations (see Cooling section).

Before powering-up, a protective earthing conductor must be connected to the protective earthing terminal and have a cross-sectional area of at least 1.5 mm².



Before mounting, using or removing this unit:

Prevent access to hazardous voltage by disconnecting the unit from power supply. Warning! Do not open connected unit. Hazardous voltage may occur within this unit when connected to power supply.



Class 1 Laser Product

Do not look directly into fibre optical fibre port or any connected fibre although this unit is designed to meet the Class 1 Laser regulations.

Care recommendations

Follow the care recommendations below to maintain full operation of unit and to fulfil the warranty obligations.

This unit must not be operating with removed covers or lids.

Do not attempt to disassemble the unit. There are no user serviceable parts inside.

Do not drop, knock or shake the unit, rough handling above the specification may cause damage to internal circuit boards.

Do not use harsh chemicals, cleaning solvents or strong detergents to clean the unit.

Do not paint the unit. Paint can clog the unit and prevent proper operation.

Do not expose the unit to any kind of liquids (rain, beverages, etc). The unit is not waterproof. Keep the unit within the specified humidity levels.

Do not use or store the unit in dusty, dirty areas, connectors as well as other mechanical part may be damaged.

If the unit is not working properly, contact the place of purchase, nearest Westermo distributor office or Westermo Tech support.

Fibre connectors are supplied with plugs to avoid contamination inside the optical port.

As soon as no optical fibre is mounted on the connector, e.g. for storage, service or transportation, the plug should be applied.

Warning:

To reduce the risk of fire, use on No. 26 AWG or larger telecommunication line cord.

Note. Fibre Optic Handling

Fibre optic equipment needs special treatment. It is very sensitive to dust and dirt. If the fibre will be disconnected from the unit the protective hood on the transmitter/receiver must be connected. The protective hood must be kept on during transportation. The fibre optic cable must also be handle the same way.

If these recommendations are not followed the warranty might be jeopardized.

Cleaning of the optical connectors

In the event of contamination, the optical connectors should only be cleaned by the use of recommended cleaning fluids and correct cleaning equipment.

Recommended cleaning fluids:

- Methyl-, ethyl-, isopropyl- or isobutyl-alcohol
- Hexane
- Naphtha

Maintenance

No maintenance is required, as long as the unit is used as intended within the specified conditions.

Agency approvals and standards compliance

Art.no	Denomination	Type	Approval/compliance
3641-4005	RFIR-219-F4G-T7G-DC	EMC	EN 50121-4, Railway applications – Electromagnetic compatibility – Emission and immunity of the signalling and telecommunications apparatus
3641-4015	RFIR-219-F4G-T7G-AC		EN 55022, Information technology equipment – Radio disturbance characteristics – Limits and methods of measurement
3641-4025	RFIR-227-F4G-T7G-DC		EN 55024, Information technology equipment – Immunity characteristics Limits and methods of measurement
3641-4035	RFIR-227-F4G-T7G-AC		EN 61000-6-1, Electromagnetic compatibility – Immunity for residential environments EN 61000-6-2, Electromagnetic compatibility – Immunity for industrial environments EN 61000-6-4, Electromagnetic compatibility – Emission for industrial environments FCC Part 15 Class A
		Marine	DNV Standard for Certification no. 2.4

FCC Part 15.105

Notice:

This equipment has been tested and found to comply with the limits for a Class A digital device, pursuant to Part 15 of the FCC Rules. These limits are designed to provide reasonable protection against harmful interference when the equipment is operated in a commercial environment. This equipment generates, uses, and can radiate radio frequency energy and, if not installed and used in accordance with the instruction manual, may cause harmful interference to radio communications. Operation of this equipment in a residential area is likely to cause harmful interference in which case the user will be required to correct the interference at his own expense.

EN 55022 Notice:

This is a class A product. In a domestic environment this product may cause radio interference in which case the user may be required to take adequate measures.

DNV Standard for Certification no. 2.4

Type	Temperature	Humidity	Vibration	EMC	Enclosure
RFIR-2xx-F4G-T7G-AC	C	B	A	A	A/IP40
RFIR-2xx-F4G-T7G-DC	D	B	A	B	A/IP40

Safety control drawing

Position	Direction/description	Input/output values
1	In/out / BI_DA+	Per port: $U = \pm 1\text{ V}$ (4V/us) $I = \pm 20\text{ mA}$ Data rate: 10/100/1000 Mbit/s
2	In/out / BI_DA-	
3	In/out / BI_DB+	
4	In/out / BI_DC+	
5	In/out / BI_DC-	
6	In/out / BI_DB-	
7	In/out / BI_DD+	
8	In/out / BI_DD-	
Shield	Functional earth	

Galvanically isolated via signal transformers and capacitively isolated to GND/Functional earth through a 2kV 1000pF capacitor.
See user manual for proven transient protection.

Position	Direction/description	Output values
1	Out / VBUS	$U_{\text{out}} = 5\text{ VDC max}$ $I_{\text{out}} = 500\text{ mA max}$
2	In/out / D-	
3	In/out / D+	
4	GND	
Shield	Functional earth	

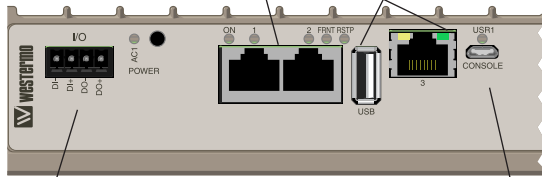

Position	Direction/description	Input/Output values
DO+	IO / Status +	$U_{\text{in}} = 60\text{ VDC max}$
DO-	IO / Status -	$I_{\text{in}} = 80\text{ mA max}$
DI+	IO / Digital in +	$U_{\text{in}} = 60\text{ VDC max}$
DI-	IO / Digital in -	$I_{\text{in}} = 2.9\text{ mA max}$

Position	Direction/description	Output values
1	In / VBUS	$U = 5\text{ VDC max}$ $I = 100\text{ mA max}$
2	In/out / D-	
3	In/out / D+	
4	Not connected	
5	Functional earth	

DC Power supply

Direction/description	Input values
In / +DC1	$U_{\text{in}} = (16 - 60)\text{ VDC}$ $I_{\text{in}} = 2.0\text{ A}@16\text{ VDC}^*$ $P_{\text{in}} = 32\text{ W}@16\text{ VDC}^*$
In / +DC2	
In / COM	
In / COM	

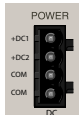

* RFIR-227-T7G-F4G-DC
 ** RFIR-227-T7G-F4G-AC

AC Power supply

Direction/description	Input values
In / P	$U_{\text{in}} = (90 - 264)\text{ VAC},$ $50 - 60\text{ Hz}$ $I_{\text{in}} = 350\text{ mA}@115\text{ VAC}^{**}$
In / N	
In / NC	
In / PE	
In / PE	

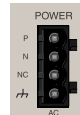

Degree of protection:	IP 40
Ambient temperature:	-40 °C to +70 °C (DC), -40 °C to +55 °C (AC)

Safety control drawing

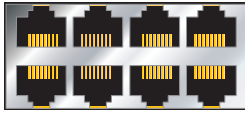

Position	Direction* / description	Input/output values
1	In/out / TD+	Per port: $U = \pm 1\text{ V}$ (4V/us) $I = \pm 20\text{ mA}$ Data rate: 10/100 Mbit/s
2	In/out / TD-	
3	In/out / RD+	
4	Not connected	
5	Not connected	
6	In/out / RD-	
7	Not connected	
8	Not connected	
Shield	Functional earth	

Galvanically isolated via signal transformers and capacitively isolated to functional earth through a 2kV 1000pF capacitor. See user manual for proven transient protection.



Position	Direction* / description	Input/output values
Rx	In / Receive port	Max 5 dBm
Tx	Out / Transmit port	

Position	Direction* / description	Input/output values
1	In/out / BI_DA+	Per port: $U = \pm 1\text{ V}$ (4V/us) $I = \pm 20\text{ mA}$ Data rate: 100/1000 Mbit/s
2	In/out / BI_DA-	
3	In/out / BI_DB+	
4	In/out / BI_DC+	
5	In/out / BI_DC-	
6	In/out / BI_DB-	
7	In/out / BI_DD+	
8	In/out / BI_DD-	
Shield	Functional earth	

Galvanically isolated via signal transformers and capacitively isolated to functional earth through a 2kV 1000pF capacitor. See user manual for proven transient protection.

* Direction relative this unit!

Declaration of Conformity



Westermo Teleindustri AB

Declaration of conformity

The manufacturer Westermo Teleindustri AB
SE-640 40 Stora Sundby, Sweden

Herewith declares that the product(s)

Type of product	Article number	Models
Industrial Ethernet Switch for 19 inch Rack mounting	3641-4025	RFIR-227-F4G-T7G-DC
	3641-4005	RFIR-219-F4G-T7G-DC
	3641-4035	RFIR-227-F4G-T7G-AC
	3641-4015	RFIR-219-F4G-T7G-AC

is in conformity with the following EC directive(s).

No	Short name
2004/108/EC	Electromagnetic Compatibility (EMC)
2011/65/EU	Restriction of the use of certain hazardous substances in electrical and electronic equipment (RoHS)

References of standards applied for this EC declaration of conformity.

No	Title	Issue
EN 50121-4	Railway applications – Electromagnetic compatibility – Emission and immunity of the signalling and telecommunications apparatus	2006
EN 55022	Information technology equipment – Radio disturbance characteristics – Limits and methods of measurement	2010
EN 55024	Information technology equipment – Immunity characteristics Limits and methods of measurement	2010
EN 61000-6-1	Electromagnetic compatibility – Immunity for residential environments	2007
EN 61000-6-2	Electromagnetic compatibility – Immunity for industrial environments	2005 + C1: 2005
EN 61000-6-4	Electromagnetic compatibility – Emission for industrial environments	2007 +A1:2011
EN 50581	Technical documentation for the assessment of electrical and electronic products with respect to the restriction of hazardous substances	2012

The last two digits of the year in which the CE marking was affixed: 14



Signature

Pierre Öberg
Technical Manager
09th September 2014

Postadress/Postal address	Tel.	Telefax	Postgiro	Bankgiro	Org.nr/ Corp. identity number	Registered office
S-640 40 Stora Sundby Sweden	016-428000 Int+46 16428000	016-428001 Int+46 16428001	52 72 79-4	5671-5550	556361-2604	Eskilstuna

Type tests and environmental conditions

Phenomena	Test	Description	Test levels
ESD	EN 61000-4-2	Enclosure contact	± 6 kV
		Enclosure air	± 8 kV
RF field AM modulated	IEC 61000-4-3	Enclosure	20 V/m 80% AM (1 kHz), 80 – 2700 MHz
Fast transient	EN 61000-4-4	Signal ports	± 2 kV
		Power ports	± 2 kV
Surge	EN 61000-4-5	Signal ports	± 2 kV line to earth, ± 1 kV line to line
		Power ports	± 2 kV line to earth, ± 2 kV line to line (AC models) ± 2 kV line to earth, ± 1 kV line to line (DC models)
RF conducted	EN 61000-4-6	Signal ports	10 V 80% AM (1 kHz), 0.15 – 80 MHz
		Power ports	10 V 80% AM (1 kHz), 0.15 – 80 MHz
Power frequency magnetic field	EN 61000-4-8	Enclosure	300 A/m 0, 16.7, 50, 60 Hz
Pulse magnetic field	EN 61000-4-9	Enclosure	300 A/m
Radiated emission	CISPR 16-2-3	Enclosure	Class A
	ANSI C63.4 (FCC part 15)	Enclosure	Class B, 30 – 6500 MHz
Conducted emission	EN 55022	AC and DC power ports Telecommunication ports Class B	Class B
	FCC part 15	AC and DC power ports	Class B
Dielectric strength	EN 60950	Signal port to other isolated ports	1.5 kVrms 50 Hz 1 min
		Power port to other isolated ports	1.5 kVrms 50 Hz 1 min
Temperature	EN 60068-2-1 EN 60068-2-2	Operating	-40 to +70°C (DC models) -40 to +55°C (AC models)
		Storage & Transport	-40 to +85°C (all models)
		Maximum surface temperature	135 °C (temperature class T4)
Humidity	EN 60068-2-27	Operating	5 to 95% relative humidity
		Storage & Transport	5 to 95% relative humidity
Altitude		Operating	2 000 m / 70 kPa
Service life		Operating	10 years
Vibration	IEC 60068-2-6	Operating	7.5 mm, 5 – 8 Hz 2 g, 8 – 500 Hz (19" rack mounting according to IEC 60297, DIN 41494)
Shock	IEC 60068-2-27	Operating	15 g, 11 ms (19" rack mounting according to IEC 60297, DIN 41494)
Enclosure	UL 94	Aluminium / Zink	Flammability class V-0 (all models)

Description

The RFIR (RedFox Industrial Rack) is a high performance layer 3 industrial Ethernet switch designed for high network traffic applications. Various port configurations are available that can be further customized with SFP transceivers. RFIR is powered by the Westermo WeOS network operating system.

RFIR is designed for 19" cabinet according to ETSI standard making it suitable for use in control room networks as well as for cabinets installed along railway trackside or maritime installations. RFIR is designed to run efficiently from an AC or DC power supply, the unit is also equipped with configurable I/O fault contact that make it ideal for easy installation and monitoring in industrial applications.

RedFox Industrial Rack models

Westermo article number	Denomination	Description
3641-4005	RFIR-219-F4G-T7G-DC	8 x 10/100 Mbit/s, Ethernet TX, RJ-45 7 x 10/100/1000 Mbit/s, Gigabit Ethernet TX, RJ-45 4 x 100/1000 Mbit/s, pluggable connections transceivers supported, Ethernet FX or TX SFP DC power supply
3641-4015	RFIR-219-F4G-T7G-AC	8 x 10/100 Mbit/s, Ethernet TX, RJ-45 7 x 10/100/1000 Mbit/s, Gigabit Ethernet TX, RJ-45 4 x 100/1000 Mbit/s, pluggable connections transceivers supported, Ethernet FX or TX SFP AC power supply
3641-4025	RFIR-227-F4G-T7G-DC	16 x 10/100 Mbit/s, Ethernet TX, RJ-45 7 x 10/100/1000 Mbit/s, Gigabit Ethernet TX, RJ-45 4 x 100/1000 Mbit/s, pluggable connections transceivers supported, Ethernet FX or TX SFP DC power supply
3641-4035	RFIR-227-F4G-T7G-AC	16 x 10/100 Mbit/s, Ethernet TX, RJ-45 7 x 10/100/1000 Mbit/s, Gigabit Ethernet TX, RJ-45 4 x 100/1000 Mbit/s, pluggable connections transceivers supported, Ethernet FX or TX SFP AC power supply

Housing

Description

The RedFox Industrial Rack (RFIR) is designed for installation in 19" rack solutions according to ETSI standard with a shallow depth of 240 mm. RFIR can also be wall mounted as an installation option.

Port number RFIR-219-F4G-T7G DC or AC

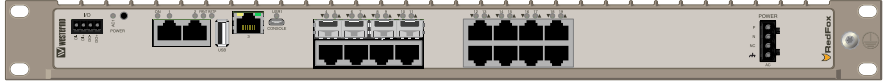

Port number RFIR-227-F4G-T7G DC or AC

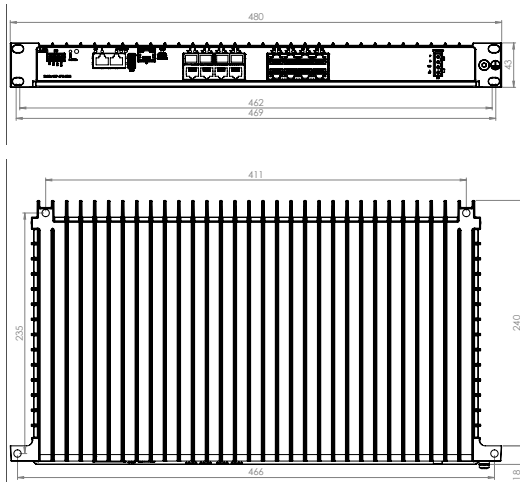

Specification

Dimension W x H x D	466 x 258 x 43 mm 18,35 x 10,16 x 1,66"
Weight	3.8 kg
Degree of protection	IP40 according to EN 60529
Cooling	Convection
Mounting	19" rack or wall-mounted

Interface specifications

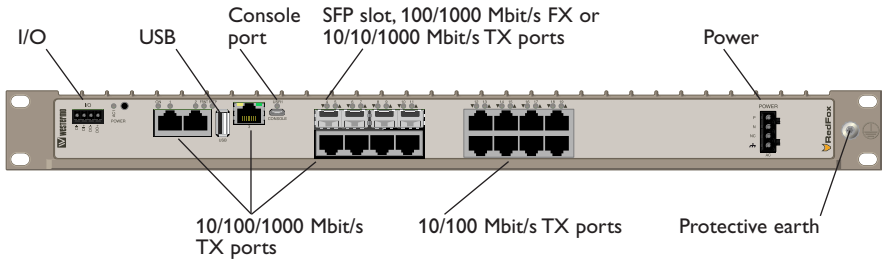

Power interface specifications

DC power

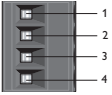
	4-position	Product marking	Direction	Description
	No. 1	+DC1	Input	Supply voltage input DC1
	No. 2	+DC2	Input	Supply voltage input DC2
	No. 3	-COM	Input	Common
	No. 4	-COM	Input	Common

AC power

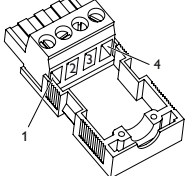
	4-position	Product marking	Direction	Description
	No. 1	P	Input	Power
	No. 2	N	Input	Neutral
	No. 3	NC	Input	No connection
	No. 4	\uparrow	Input	Functional earth

Power		
Rated voltage	AC models	115 to 230 VAC
	DC models	20 to 48 VDC
Operating voltage	AC models	90 to 264 VAC
	DC models	16 to 60 VDC
Maximum nominal current consumption	RFIR-219-F4G-T7G-DC	1120mA @ 24 VDC 450mA @ 48 VDC
	RFIR-227-F4G-T7G-DC	1250mA @ 24 VDC 550mA @ 48 VDC
	RFIR-219-F4G-T7G-AC	350mA @ 115 VAC 60 Hz 210mA @ 230 VAC 50 Hz
	RFIR-227-F4G-T7G-AC	380mA @ 115 VAC 60Hz 240mA @ 230 VAC 50Hz
Fuse rating	All models	4A(T)**
Inrush current	DC models	25mA2 @ 24 VDC 165mA2 @ 48 VDC
	AC models	75mA2 @ 115 VAC 340mA2 @ 230 VAC
Startup current*	All models	2x nominal current
Rated frequency	AC models	50/60 Hz
	DC models	DC
Polarity	AC models	Not applicable
	DC models	Reverse polarity protected
Redundant power input	AC models	No
	DC models	Yes
Isolation to		All other
Connection		Detachable screw terminal
Connector size	All models	0.2 – 2.5 mm2 (AWG 24 – 12)
Shielded cable		Not required

* External supply current capability for proper start-up

** Denote time-delay fuse

Console



Connection to console port

The console port can be used to connect to the CLI (Command Line Interface). The console connector is a micro USB cable that connects to a FTDI FT232R USB to serial converter internally. For drivers please see www.ftdichip.com and download the appropriate VCP driver.

Console	
Electrical specification	USB 2.0 device interface
Data rate	High speed 480mbit/s
Circuit type	SE LV
Maximum supply current	100 mA
Isolation to	All other except USB
Galvanic connection to	USB
Connection	USB Micro-B connector in device mode

USB



USB	
Electrical specification	USB 2.0 host interface
Data rate	High speed 480mbit/s
Circuit type	SELV
Maximum supply current	500 mA
Isolation to	All other except Console
Connection	USB receptacle connector type A
Conductive housing	Yes

Network ports

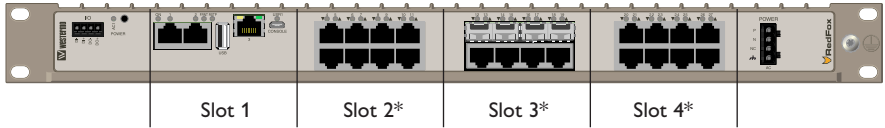

RFIR-219-F4G-T7G DC and AC	
Slot 1	
1	10/100/1000 Mbit/s, TX port
2	10/100/1000 Mbit/s, TX port
3	10/100/1000 Mbit/s, TX port
Slot 2	
4	SFP slot
5	10/100/1000 Mbit/s, TX port
6	SFP slot
7	10/100/1000 Mbit/s, TX port
8	SFP slot
9	10/100/1000 Mbit/s, TX port
10	SFP slot
11	10/100/1000 Mbit/s, TX port
Slot 3	
12	10/100 Mbit/s, TX port
13	10/100 Mbit/s, TX port
14	10/100 Mbit/s, TX port
15	10/100 Mbit/s, TX port
16	10/100 Mbit/s, TX port
17	10/100 Mbit/s, TX port
18	10/100 Mbit/s, TX port
19	10/100 Mbit/s, TX port

RFIR-227-F4G-T7G DC and AC	
Slot 1	
1	10/100/1000 Mbit/s, TX port
2	10/100/1000 Mbit/s, TX port
3	10/100/1000 Mbit/s, TX port
Slot 2	
4	10/100 Mbit/s, TX port
5	10/100 Mbit/s, TX port
6	10/100 Mbit/s, TX port
7	10/100 Mbit/s, TX port
8	10/100 Mbit/s, TX port
9	10/100 Mbit/s, TX port
10	10/100 Mbit/s, TX port
11	10/100 Mbit/s, TX port
Slot 3	
12	SFP slot
13	10/100/1000 Mbit/s, TX port
14	SFP slot
15	10/100/1000 Mbit/s, TX port
16	SFP slot
17	10/100/1000 Mbit/s, TX port
18	SFP slot
19	10/100/1000 Mbit/s, TX port
Slot 4	
20	10/100 Mbit/s, TX port
21	10/100 Mbit/s, TX port
22	10/100 Mbit/s, TX port
23	10/100 Mbit/s, TX port
24	10/100 Mbit/s, TX port
25	10/100 Mbit/s, TX port
26	10/100 Mbit/s, TX port
27	10/100 Mbit/s, TX port

* Network ports at slot 2 and slot 3 differ between the different RFIR models. Slot 4 is only available in model RFIR-227-F4G-T7G DC and AC.

10/100/1000 Mbit/s, TX ports

Ethernet TX	
Electrical specification	IEEE std 802.3. 2005 Edition
Data rate	10 Mbit/s, 100 Mbit/s, 1000 Mbit/s, manual or auto
Duplex	Full or half, manual or auto
Circuit type	TNV-1
Transmission range	Up to 150 m with CAT5e cable or better
Isolation to	All other
Connection	RJ-45 auto MDI/MDI-X
Shielded cable	Not required, except when installed in Railway applications as signalling and telecommunications apparatus and located close to rails*
Conductive housing	Yes

* **NOTE!** Railway installation close to the rails.

To minimise the risk of interference, a shielded cable is recommended when the cable is located inside 3 m boundary to the rails and connected to this port.

The cable shield should be properly connected (360°) to an earthing point within 1 m from this port. This earthing point should have a low impedance connection to the conductive enclosure of the apparatus cabinet, or similar, where the unit is built-in. This conductive enclosure should be connected to the earthing system of an installation and may be directly connected to the functional earth. Refer also to "Safety" section.



Position	Direction*	Description
1	In/Out	BI_DA+
2	In/Out	BI_DA-
3	In/Out	BI_DB+
4	In/Out	BI_DC+
5	In/Out	BI_DC-
6	In/Out	BI_DB-
7	In/Out	BI_DD+
8	In/Out	BI_DD-
Shield	In/Out	Connected to Functional earth

* Direction relative this unit.

SFP slot

Each SFP slot can hold one SFP transceiver for copper or fibre cable. Fibre transceivers distances range from 550 m (0.34 mi) to 120 km (74.6 mi). For supported transceivers, see SFP data sheet.



Position	Direction*	Description
Rx	In	Receive port
Tx	Out	Transmit port

* Direction relative this unit.

SFP ports	
Optical/Electrical specification	IEEE std 802.3 2005 Edition
Data rate	10, 100 or 1000 Mbit/s*
Duplex	Full or half, manual or auto
Transmission range	Depending on transceiver
Connection	SFP slot holding fibre transceiver or copper transceiver

* 100 Mbit/s or 1000 Mbit/s transceiver supported.

I/O connection

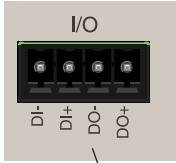

	Product marking	Direction	Description
	Digital in -	Input	Digital in -
	Digital in +	Input	Digital in +
	Status -	Output	Alarm relay (status) contact
	Status +	Output	Alarm relay (status) contact

The Status output is a potential free, opto-isolated normally closed solid-state relay. This can be configured to monitor various alarm events within the RFIR unit, see WeOS Management Guide. An external load in series with an external voltage source is required for proper functionality. For voltage/current ratings, see Interface specification section.

The Digital in is an opto-isolated digital input which can be used to monitor external events. For voltage/current ratings, see Interface Specification section:

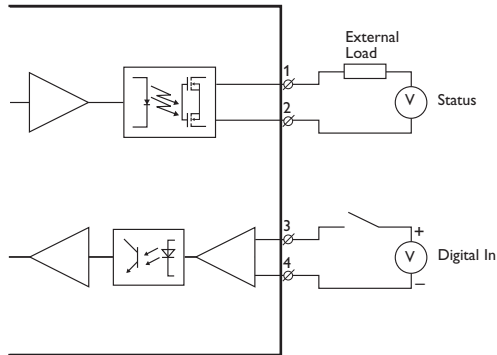

IO / Relay output	
Connect resistance	30 Ω
Isolation to	All other
Connection	Detachable screw terminal
Connector size	0.2 – 2.5 mm ² (AWG 24 – 12)
Maximum voltage/current	60VDC / 80 mA
IO / Digital input	
Voltage levels	$V_{ih} > 8V$ $V_{il} < 5V$ $I_{in} = 2.9mA @60V$
Isolation to	All other
Connection	Detachable screw terminal
Connector size	0.2 – 2.5 mm ² (AWG 24 – 12)
Maximum voltage	60 VDC

LED indicators Power/CPU

LED	Status	Description
ON	OFF	Unit has no power.
	GREEN	All OK, no alarm condition.
	RED	Alarm condition, or until unit has started up. (Alarm conditions are configurable, see "WeOS Management Guide").
	BLINK	Location indicator ("Here I am!"). Activated when connected to IPConfig Tool, or upon request from Web or CLI.
DC1	OFF	Unit has no power.
	GREEN	Power OK on DC1.
	RED	+DC1 input voltage is below operating voltage limit
DC2	OFF	Unit has no power.
	GREEN	Power OK on DC2.
	RED	+DC2 input voltage is below operating voltage limit
AC1	OFF	Unit has no power
	GREEN	Power OK on AC1
FRNT	OFF	FRNT disabled.
	GREEN	FRNT OK.
	RED	FRNT Error.
	BLINK	Unit configured as FRNT Focal Point.
RSTP	OFF	RSTP disabled.
	GREEN	RSTP enabled.
	BLINK	Unit elected as RSTP/STP root switch.
USR1	<i>Configurable, see WeOS Management Guide</i>	
TX/FX ports	OFF	No link.
	GREEN	Link established.
	GREEN FLASH	Data traffic indication.
	YELLOW	Port alarm and no link. Or if FRNT or RSTP mode, port is blocked.

SFP Transceivers

See SFP Transceivers data sheet for supported SFP transceivers.
Note: The unit supports Westermo labelled transceivers only.
See Transceiver User Guide 6100-0000 for transceiver handling instructions.

Deviations

With *copper transceiver 1100-0148* the specified operating temperature on the RFI and RFIR series is 0 to 50°C.

FRNT reconfiguration times can not be guaranteed with copper transceivers.



Mounting

This unit can either be rackmounted or wallmounted, see figures below.

Rackmounting

The unit can be mounted in all directions inside a 19" apparatus cabinet. Use M6x25 or 1/4"x1" screws.

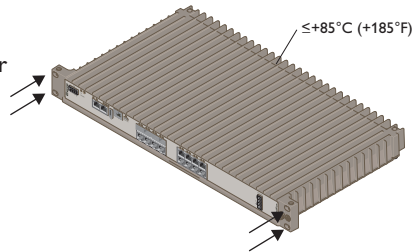

Wallmounting

The unit can also be wallmounted in all directions. Use maximum $\text{Ø}6,4$ mm or 1/4" screws.

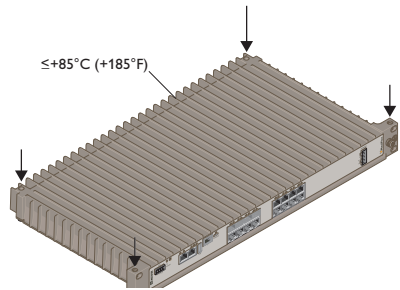

Cooling

For mounting in 19" apparatus cabinet without forced ventilation, a minimal spacing of 1U according to IEC 60297 or 45 mm (1.75") above/below is recommended. With forced ventilation, no minimal spacing is required as long as the temperature of the rear cooling plates does not exceed $+85^{\circ}\text{C}$ ($+185^{\circ}\text{F}$).

For wallmounting in an area without forced ventilation, a minimum spacing of 45 mm (1.75") above/below and 10 mm (0.4") left/right is recommended. For areas with forced ventilation, no minimal spacing is required as long as the temperature of the rear cooling plates does not exceed $+85^{\circ}\text{C}$ ($+185^{\circ}\text{F}$).

Earth connection

For correct function, the ground connection on the unit needs to be properly connected to a solid ground. See the figure below.

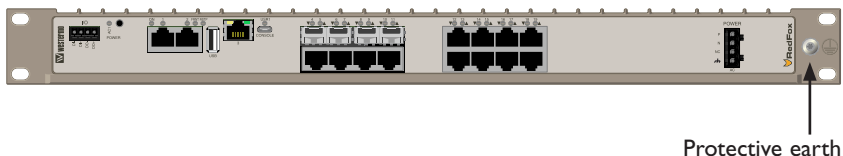

Getting Started

This product runs Westermo Operating System (WeOS) which provides several management tools that can be used for configuration of the unit.

- **WeConfig**
WeConfig is a Network configuration management tool (NCM) made for commissioning and maintenance of components in a network.
- **Web**
Configuration of the unit using the web browser.
- **CLI**
Configuration of the unit via the Command Line Interface.

If the computer is located in the same subnet as the switch you can easily use a web browser to configure the unit. Within the web you can configure most of the available functions.

For advanced network settings and more diagnostic information, please use the CLI. Detailed documentation is available in the chapter "The Command Line Management Tool" in the WeOS management guide.

Factory default	<i>IP address:</i>	192.168.2.200 (and DHCP client)
	<i>Netmask:</i>	255.255.255.0
	<i>Gateway:</i>	Disabled

Note! If you are not sure about the subnet – consult your network administrator.

Configuration

Configure the unit via Web browser

The unit can easily be configured via a Web browser.

Open the link <http://192.168.2.200> in your web browser, and you will be prompted with a Login screen, where the default settings for Username and Password are:

Username: admin

Password: westermo

Once you have logged in, you can use the extensive integrated help function describing all configuration options. Two common task when configuring a new switch is to assign appropriate IP settings, and to change the password of the admin account. The password can be up to 64 characters long, and should consist of printable ASCII characters (ASCII 33-126); 'Space' is not a valid password character.

Referring documents

All needed documentation can be downloaded from the product webpage. Related software tools are available in the folder software tools under technical support on the Westermo website.

Type	Description	Document number
Management Guide	Westermo OS management guide	6101-3201

Cable factory reset on RedFox Industrial Rack

It is possible to set the unit to factory default settings by using a standard (straight) Ethernet RJ-45 cable.

1. Power off the switch and disconnect all Ethernet cables (including copper and fibre).
2. Connect an Ethernet cable between Ethernet port 1 and Ethernet port 2. The ports need to be connected directly by an Ethernet cable, i.e., not via a hub or switch. Use a straight cable - not a cross-over cables - when connecting the ports.
3. Power on the unit.
4. Wait for the unit to start up. Control that the ON LED is flashing red. The ON LED flashing indicates that the unit is now ready to be reset to factory default. You now have the choice to go ahead with the factory reset, or to skip factory reset and boot as normal.
 - Go ahead with factory reset: Acknowledge that you wish to conduct the factory reset by unplugging the Ethernet cable. The ON LED will stop flashing. This initiates the factory reset process, and the unit will restart with factory default settings. When the switch has booted up, the ON LED will show a green light, and is now ready to use.
 - Note! Do not power off the unit while the factory reset process is in progress. Skip the factory reset: To skip the factory reset process, just wait for approximately 30 seconds (after the ON LED starts flashing RED) without unplugging the Ethernet cable. The switch will conduct a normal boot with the existing settings.



Westermo • SE-640 40 Stora Sundby, Sweden
Tel +46 16 42 80 00 Fax +46 16 42 80 01
E-mail: info@westermo.com
www.westermo.com

Sales Units

Westermo Data Communications

China

sales.cn@westermo.com
www.cn.westermo.com

France

infos@westermo.fr
www.westermo.fr

Germany

info@westermo.de
www.westermo.de

North America

info@westermo.com
www.westermo.com

Singapore

sales@westermo.com.sg
www.westermo.com

Sweden

info.sverige@westermo.se
www.westermo.se

United Kingdom

sales@westermo.co.uk
www.westermo.co.uk

Other Offices



For complete contact information, please visit our website at www.westermo.com/contact or scan the QR code