

X410™ Web-Enabled Programmable Controller

Models: X-410-I, X-410-E

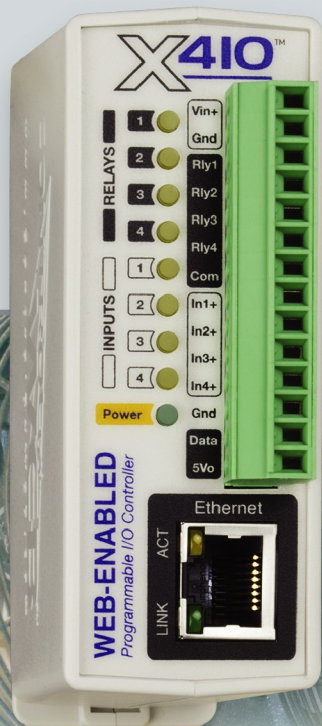

USERS MANUAL

Rev 1.2

X-410 Features

- 4 Relays
- 4 Digital Inputs
- 1-Wire Bus - Up to 16 Temp/Humidity Sensors
- Add up to 32 Remote Device
- Remotely Control up to 100 I/O
- Logic Task Builder (no scripting required)
- User Permissions - Admin, Manager, User
- Built-in Web Server (HTTP/HTTPS)
- Custom Control Page
- Monitor Supply Voltage
- Email Notifications (SSL Supported)
- BASIC Scripting
- Scheduling
- Logging

CONTROL by WEB™
www.ControlByWeb.com

a division of Xytronix Research & Design, Inc. Nibley, Utah, USA

| X-410 User Manual Revisions | |
|------------------------------------|-----------------------|
| Revision | Description |
| 1.0 | Initial release. |
| 1.1 | Miscellaneous updates |
| 1.2 | Miscellaneous updates |

Table of Contents

| | |
|---|-----------|
| Section 1: Introduction..... | 8 |
| 1.1 Features..... | 9 |
| 1.2 Applications..... | 11 |
| 1.3 Part Numbers and Accessories..... | 12 |
| 1.3.1 Optional Accessories..... | 12 |
| 1.4 Security Notes..... | 13 |
| 1.5 Connectors & Indicators..... | 14 |
| 1.6 Accessing the X-410 using a Web Browser..... | 15 |
| Section 2: Installation and Connections..... | 16 |
| 2.1 Installation Guidelines..... | 16 |
| 2.2 Making Connections..... | 17 |
| 2.3 Relay Connections (Control a device over an IP network)..... | 18 |
| 2.4 1-Wire Sensor Connections..... | 20 |
| 2.5 Digital Input Connections..... | 22 |
| 2.5.1 DC Input Connections..... | 22 |
| 2.5.2 Switch-Closure Connections..... | 23 |
| 2.5.3 Water Leak Sensor Connections..... | 24 |
| 2.5.4 AC Input Connections..... | 25 |
| 2.5.5 Network Connection..... | 26 |
| 2.6 Establishing Communications for Setup..... | 27 |
| 2.6.1 Method 1: Assign a Temporary IP Address to the Configuration Computer | 27 |
| 2.6.2 Method 2: Assign a Temporary IP address to the X-410..... | 31 |
| Microsoft Windows Instructions..... | 31 |
| Linux/Unix Instructions..... | 31 |
| Mac OS X Instructions..... | 32 |
| Section 3: Web Server and Setup Pages..... | 33 |
| 3.1 Setup Strategy..... | 33 |
| 3.2 General Settings Tab..... | 34 |
| 3.2.1 General Settings Tab > GENERAL INFORMATION..... | 34 |
| 3.2.2 General Settings Tab > NETWORK SETTINGS..... | 36 |
| 3.2.2.1Hidden Network Setting..... | 38 |
| 3.2.3 General Settings Tab > ADVANCED NETWORK SETTINGS..... | 39 |
| 3.2.4 General Settings Tab > EMAIL SETTINGS..... | 46 |
| Email Notification Description..... | 48 |
| 3.2.5 General Settings Tab > PASSWORDS..... | 49 |
| 3.2.6 General Settings Tab > DATE & TIME..... | 50 |
| Manual Time Configuration..... | 51 |
| SYNC With NTP Server..... | 51 |
| 3.2.7 General Settings Tab > BACKUP/RESTORE..... | 54 |
| 3.3 Remote Devices Tab | 55 |
| Remote Device Monitor and Control:..... | 57 |
| Notes for Remote Devices..... | 58 |
| 3.4 I/O Setup Tab..... | 59 |
| 3.4.1 I/O Setup Tab > RELAYS..... | 59 |
| Relay Options..... | 60 |

| | |
|--|------------|
| Local Relay Options..... | 60 |
| Remote Relay Options..... | 61 |
| 3.4.2 I/O Setup Tab > DIGITAL INPUTS..... | 62 |
| Digital Input Options..... | 62 |
| Counter Options..... | 64 |
| Remote Digital Input Options..... | 64 |
| 3.4.3 I/O Setup Tab > 1-Wire SENSORS..... | 65 |
| 1-Wire Options..... | 66 |
| Local 1-Wire Options..... | 66 |
| Remote 1-Wire Options..... | 66 |
| 3.4.4 I/O Setup Tab > REGISTERS..... | 67 |
| Register Options..... | 67 |
| Local Register Options..... | 68 |
| Remote Register Options..... | 68 |
| 3.4.5 I/O Setup Tab > Vin..... | 69 |
| Vin Options..... | 69 |
| Remote Vin Options..... | 69 |
| 3.4.6 I/O Setup Tab > TIMERS..... | 70 |
| 3.5 Control Logic Tab..... | 71 |
| 3.5.1 Control Logic Tab > TASK/FUNCTIONS..... | 71 |
| 3.5.1.1 Scheduled Tasks..... | 72 |
| 3.5.1.2 Conditional Tasks..... | 77 |
| 3.5.1.3 Automatic Reboot Tasks..... | 82 |
| 3.5.1.4 Override Schedules..... | 85 |
| 3.5.2 Control Logic Tab > BASIC SCRIPT..... | 86 |
| BASIC I/O Tokens..... | 87 |
| 3.6 Logging Tab..... | 88 |
| 3.6.1 Logging Tab > GENERAL LOGGING SETTINGS | 88 |
| 3.6.1.1 Logging Tab > LOG I/O..... | 89 |
| 3.6.1.2 Diagnostic Settings..... | 90 |
| 3.6.1.3 Send Log File..... | 91 |
| 3.7 Monitor & Control Tab..... | 93 |
| 3.7.1 Monitor & Control Tab > CONTROL PAGE..... | 93 |
| 3.7.2 Monitor & Control Tab > CONTROL PAGE SETUP..... | 94 |
| Control Page Widgets..... | 95 |
| Add I/O to the Control Page..... | 96 |
| Gap Widgets..... | 96 |
| Relay Widget Editor..... | 97 |
| Digital Input Widget Editor..... | 98 |
| Input Counter Widget Editor..... | 98 |
| Register Widget Editor..... | 99 |
| 3.7.3 Monitor & Control Tab > GRAPH LOG FILE..... | 101 |
| 3.7.3.1 Settings..... | 101 |
| 3.7.3.2 Settings..... | 101 |
| Section 4: Control Page..... | 102 |
| 4.1 Browser Operation..... | 102 |
| 1. Control Page..... | 102 |
| 2. Control Page via Setup Tabs..... | 102 |
| Section 5: Example Control Scenarios..... | 103 |
| 5.1 Control Logic Examples Using Tasks/Functions..... | 103 |
| 5.1.1 Temperature Alarm ON (or OFF) Only..... | 103 |

| | | |
|-------------------|---|------------|
| 5.1.2 | Temperature Alarm ON & OFF..... | 104 |
| 5.1.3 | Send an email if the temperature is less than 33°C between 9:30PM and 10PM each day..... | 105 |
| 5.1.4 | Log a counter value at midnight and reset the counter to 0 to begin the next day..... | 106 |
| 5.1.5 | Send a delayed email/text message (or delay enabling relay)..... | 107 |
| 5.1.6 | Only allow one relay to be on at a time..... | 108 |
| 5.1.7 | When Input 1 goes on, pulse Relay 1 five times and then stop..... | 109 |
| 5.1.8 | Send Email if Input stops toggling..... | 110 |
| 5.1.9 | If input 1 is on, continually turn relay on and off at a rate of 1 change per second..... | 111 |
| 5.1.10 | Turn on relay when Input 1 AND Input 2 is on. Turn off when either go off..... | 112 |
| 5.1.11 | Turn on Relay 3 when X-410 supply voltage falls below 11V..... | 113 |
| 5.1.12 | Scheduled Relay Control with Manual Override..... | 114 |
| 5.1.13 | Send an email message every 24 hours..... | 115 |
| 5.1.14 | Turn Relay 1 off after 5 seconds no matter how it got turned on..... | 116 |
| 5.1.15 | Require Input to stay on for 5 seconds before triggering..... | 117 |
| 5.1.16 | Network Monitor between two X-410 Devices (Advanced)..... | 118 |
| 5.2 | Control logic examples using BASIC Scripts..... | 120 |
| 5.2.1 | If a temperature is in the alarm state, send an email every hour..... | 120 |
| 5.2.2 | School bell controller offers lockdown/alert bell sequence via the control page..... | 121 |
| 5.2.3 | Monitor 4 doors, send an Email if a door is open more than 5-minutes..... | 122 |
| 5.2.4 | Temperature controller with time triggered email alarm..... | 123 |
| 5.2.5 | Remote control a water pump..... | 124 |
| 5.2.6 | If a digital input is on, cycle an alarm relay on and off continuously..... | 125 |
| 5.2.7 | Measure the running average frequency of a digital input..... | 126 |
| 5.2.8 | Send an email if the AC power fails..... | 127 |
| 5.2.9 | Monitor a generator. Send an email if it runs for more than 10 seconds..... | 128 |
| 5.2.10 | Automatic generator start..... | 129 |
| Section 6: | Auxiliary Operations..... | 130 |
| 6.1 | XML..... | 130 |
| 6.1.1 | state.xml..... | 130 |
| | Reading state.xml..... | 130 |
| | Controlling with state.xml..... | 131 |
| 6.1.2 | customState.xml..... | 132 |
| 6.2 | JSON..... | 133 |
| 6.3 | HTTP GET Requests (for custom applications)..... | 134 |
| 6.3.1 | Using GET for Control and Monitoring..... | 134 |
| 6.4 | SNMP Requests, Objects and Community Strings..... | 135 |
| 6.4.1 | Standard Objects..... | 135 |
| 6.4.2 | X-410 Objects..... | 135 |
| 6.4.3 | TRAPS..... | 135 |
| 6.4.4 | Notifications..... | 135 |
| 6.4.5 | Community Strings..... | 136 |
| 6.4.6 | SNMP V3 User-Based Security Model..... | 136 |
| 6.5 | External Server and Remote Services..... | 137 |
| 6.5.1 | Accessing the X-410 with custom software or third party applications..... | 137 |
| 6.5.2 | Using an External Web Server..... | 137 |
| | Direct Server Control..... | 137 |
| | Remote Services..... | 137 |
| | Connection String..... | 138 |
| 6.6 | Log Files..... | 139 |
| | Data Log File – log.txt..... | 139 |
| | System Log File – syslog.txt..... | 141 |
| 6.7 | Modbus/TCP..... | 142 |

| | | |
|--|--|------------|
| 6.7.1 | X-410 Function Code Summary..... | 142 |
| 6.7.2 | Read Coils - Modbus Function Code 01 (0x01)..... | 143 |
| | Request..... | 143 |
| | Response..... | 143 |
| | Errors..... | 143 |
| 6.7.3 | Read Discrete Inputs – Modbus Function Code 02 (0x02)..... | 144 |
| | Request..... | 144 |
| | Response..... | 144 |
| | Errors..... | 144 |
| 6.7.4 | Read Holding Registers – Modbus Function Code 03 (0x03) | 145 |
| | Request..... | 145 |
| | Response..... | 145 |
| | Errors..... | 145 |
| 6.7.5 | Write Single Coil – Modbus Function Code 05 (0x05)..... | 146 |
| | Request..... | 146 |
| | Response..... | 146 |
| | Errors..... | 146 |
| 6.7.6 | Write Multiple Coils - Modbus Function Code 15 (0x0F)..... | 147 |
| | Request..... | 147 |
| | Response..... | 147 |
| | Errors..... | 147 |
| 6.7.7 | Write Multiple Registers – Modbus Function Code 16 (0x10)..... | 148 |
| | Request..... | 148 |
| | Response..... | 148 |
| | Errors..... | 148 |
| 6.8 | Basic Scripts..... | 149 |
| 6.8.1 | Structure..... | 149 |
| 6.8.2 | Line Format..... | 149 |
| 6.8.3 | Supported Statements..... | 150 |
| | LET..... | 150 |
| | IF THEN, ELSE, END IF | 150 |
| | FOR TO, NEXT..... | 150 |
| | DO WHILE, LOOP..... | 150 |
| | LOG..... | 151 |
| | EMAIL..... | 151 |
| | END | 151 |
| | CALL | 151 |
| | SUB, END SUB..... | 151 |
| | REM or ' | 152 |
| 6.8.4 | User-Defined Variables..... | 152 |
| 6.8.5 | Predefined Variables..... | 152 |
| | Timer Variables..... | 152 |
| | Date and Time Variables..... | 152 |
| | Event Variables..... | 153 |
| 6.8.6 | I/O Variables..... | 153 |
| | Relay Variables..... | 154 |
| | Input Variables..... | 154 |
| | Registers..... | 154 |
| | Counter Variables..... | 155 |
| | Analog Variables..... | 155 |
| | Temperature/Humidity Sensor Variables..... | 155 |
| Appendix A: Restoring Factory Default Settings..... | | 157 |

| | |
|---|------------|
| Appendix B: Installing New Firmware..... | 158 |
| Appendix C: Accessing the X-410 Over the Internet..... | 160 |
| IP Addresses..... | 160 |
| A Simple Local Area Network..... | 160 |
| A Simple LAN connected to the Internet..... | 161 |
| Port Forwarding..... | 162 |
| Accessing Setup Pages..... | 163 |
| Appendix D: Specifications..... | 164 |
| Appendix E: Trademark and Copyright Information..... | 167 |
| Appendix F: Warranty..... | 168 |
| Appendix G: FCC Statement..... | 169 |
| Appendix H: Licensing..... | 170 |
| Appendix I: Mechanical Dimensions..... | 171 |

Section 1: Introduction

The X-410™ is a multifunction web-enabled module for control and monitoring. The X-410 has four internal relays, four digital inputs, four pulse counters, 16 general purpose timers, 16 general purpose registers and a 1-Wire® bus. The 1-Wire bus supports up to sixteen sensors for monitoring temperature, humidity and more. It can be controlled and/or monitored over any TCP/IP network including private networks, IP-based industrial control networks, and the Internet. Users can operate the X-410 using a web browser, the CBW Mobile app, or custom applications written for a computer, PLC, or other automation controller.

The X-410's built-in interface allows you to create custom "Tasks" for simple and advanced control logic. Create tasks based on time, input or outputs' status, or the responsiveness of remote devices. The X-410 also has a built-in BASIC interpreter for custom applications not achievable through the Task Builder system.

Other features are also included such as, email notification, event scheduling, and logging. The X-410 can control and monitor up to 32 remote devices, graph logged data, FTP logged data, email logged data, send encrypted emails, and monitor its power supply voltage.

The X-410 supports a number of Ethernet protocols including: HTTP/HTTPS, Modbus/TCP, SNMP V1,V2 & V3, NTP, SMTP(Encrypted), and FTP/FTPS. The status of the device can be retrieved in human readable formats XML and JSON.

The X-410 supports TLS V1.2 encryption as well as cloud integration(not required) for easier configuration and access. Specifically the X-410 supports HTTPS connections, can send encrypted emails, can communicate with remote devices using TLS, and send logged data to FTP servers over an encrypted connection.

In addition, the X-410 can be configured to automatically connect to ControlByWeb.cloud, ControlByWeb's cloud service. This feature is not required, but does simplify the configuration process and internet access to an X-410 installed behind a network router by eliminating manual configuration of the device and port forwarding setup on routers.

The module is powered by an external wall transformer (9-28 VDC), solar panel, or other DC power source. The model X-410-E is powered over the twisted-pair Ethernet cable.

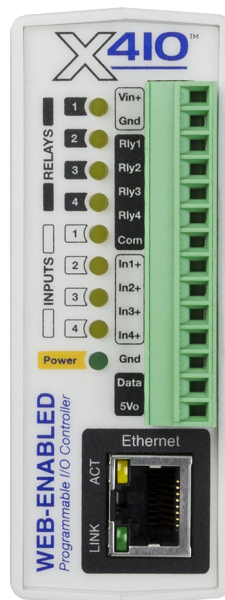

1.1 Features

- Built-in web server for configuration and remote monitoring (HTTPS supported).
- Four relays.
- Four digital inputs. Use the inputs to control relays or trigger email messages, etc.
- Four pulse counters.
- 1-Wire port for connecting up to 16 digital sensors for measuring temperature, humidity and more.
- 1-Wire temperature sensors are available in various packaging and accuracy. A list of compatible 1-Wire sensors can be found in the *Optional Accessories* table.
- Powered from a 9 to 28V DC power adapter. The power supply voltage is monitored internally and can be monitored and logged. The model X-410-E is an Ethernet powered device (PD).
- Sensor/Input status can control I/O on other ControlByWeb devices.
- Control/Logic Task Builder for custom control with no scripting necessary.
- Configurable logging of all I/O, both local and remote.
- Real-time clock with manual or NTP time sync.
- Send email alerts (up to 8 addresses) based on any sensor or input conditions.
- Send encrypted emails.
- Auxiliary protocols including *Modbus/TCP*, *SNMP V1, V2 & V3*, and *Remote Services*.
- Custom scripts using the built-in BASIC interpreter provide additional flexibility.
- Ethernet auto-negotiation automatically selects speed, duplex mode and works with straight or crossover cables.
- Simple and easy to use.
- 5-year warranty.

Relay Outputs (4)

The X-410 has four internal relays to operate indicator lights, interposer relays, and other low voltage devices. Control the relays with a web browser, timers, input changes, or programmable logic. The relay contacts are normally open with the common terminals tied together. The screw terminals are internally connected directly to the relays with no internal fuse or other over-current protection. The relay contacts are isolated from all other circuits.

Digital Inputs (4)

The X-410 has four digital inputs. The inputs have a photo-coupler circuit, however, the photo couplers are tied to the Gnd terminal of the X-410 and are not isolated. Each Input has the ability to capture the total on time since power up, the total on time since the input was last off, count the number of rising/falling edges, or act as a low frequency input. Inputs can be monitored and used to control logic.

1-Wire Sensor Bus

The X-410 has a 1-Wire port for connecting up to sixteen digital sensors for measuring temperature, humidity and more. The sensors are available in several configurations, are interchangeable and require no calibration. The sensors require three connections for communications and power (+5V, Gnd, Data). Control relays or trigger email messages based upon these values.

Remote Devices (32)

Control and monitor up to 100 I/O points, including local and remote I/O. Up to 32 other ControlByWeb products can be added to the X-410. Once a remote device has been added to the X-410 and the desired I/O on that device has been configured, the remote I/O function the same as the local I/O on the X-410.

Power Supply

The X-410 employs a modern switch-mode power supply which works from 9 to 28VDC. With this type of power supply, the current draw decreases as the voltage increases. The model X-410-E is an Ethernet powered device (PD) and receives power along with data on the twisted pair Ethernet cable. The X-410-E can also accept power on the Vin+ and Vin- terminals. The power supply voltage (Vin+) is monitored internally and can be displayed, logged, used to control local/remote relays and configured to send email notifications.

Real-time Clock

Manual or NTP capability.

Control/Logic Task Builder

Easily program up to 50 scheduled task, 50 conditional tasks, 16 automatic reboot tasks, and 20 Override Schedules.

Logging

Configurable logging of relay and input states, 1-Wire sensor data, Vin and Register values, both local and remote. System logging of device operating parameters and events, such as power reset and NTP requests.

Graphing

Logged data can be graphed directly by any HTML 5 compatible web browser.

Email Notification

Send email alerts based on any sensor or input conditions, such as temperature, time, digital inputs, power supply levels, and more. Send text messages to a cell phone through a wireless carrier's email bridge. The X-410 supports encrypted emails using either implicit or explicit TLS (STARTTLS).

BASIC Script

The X-410 has a built-in BASIC interpreter for custom applications not provided by the normal built-in Task Builder.

Web Server and Protocols

All built-in services and protocols are configurable through the built-in, password protected, TLS enabled web server (HTTP/HTTPS). Other supported protocols include Modbus/TCP, and SNMP V1,V2 & V3. The X-410 IP address configuration can be either static or set through DHCP.

1.2 Applications

The X-410 was designed to meet a broad range of industrial applications. It works well as a stand-alone device that can be controlled using a web browser, or as a convenient way to add I/O to a computer or existing system. It can easily be configured using its menus and drop-down lists, or it can run a simple BASIC script. Many of its features such as scheduling, logging, input state monitoring, and the ability to control both local and remote I/O make the X-410 a powerful, yet simple controller.

Use the X-410 to control motors, lights, coils, pumps, valves, bells, etc. Use it to monitor alarms sensors, switches, fluid level switches, battery voltage, temperature, humidity, and much more. A few example applications include:

- Bell Controller
- I/O Extender
- Industrial Thermostat
- Solar Energy Controller
- Process Controller
- Control tennis court lighting from your office
- Control a fan from your workstation
- Open a gate with your smart phone

The X-410 can be operated using a web browser through the built-in, customizable control page, by sending Modbus/TCP requests and/or SNMP requests. Custom applications can also be written to communicate with the device using the aforementioned protocols (HTTP, MODBUS, SNMP).



The X-410 can control up to 100 local and remote I/O. The local I/O count towards the 100 I/O total, some local I/O cannot be added/removed such as the relays and digital inputs. For example, you could configure the device to monitor 90 remote I/O and the 10 non-configurable local I/O. Or, in addition to the 10 non-configurable I/O you could add 16 local 1-Wire sensors, 15 local registers, and 16 local timers and have 43 remote I/O.

1.3 Part Numbers and Accessories

The X-410 is currently available in two different models:

| Part Number | Power Supply Requirements |
|-------------|------------------------------------|
| X-410-I | 9-28VDC |
| X-410-E | Power Over Ethernet and/or 9-28VDC |

1.3.1 Optional Accessories

| Accessory | Description | Part Number |
|--|---|-------------|
| Power Supply | Regulated, DIN-rail / wall mount 24V DC, 1.75Amp, 100-240V AC Input | 2868648 |
| Power Supply | Regulated, plug in 12V DC, 1.5Amp, 100-240V AC Input | PS12VW1.5-B |
| Temperature/Humidity Sensor Probe  | Digital temperature and humidity sensor probe -40°C to +80°C $\pm 0.4^\circ\text{C}$, 0-99%RH $\pm 2\%$ | X-DTHS-P |
| Thermocouple to 1-Wire Adapter  | Thermocouple to 1-Wire interface, Type K -200°C to +1250°C, $\pm 0.5^\circ\text{C}$ | X-TC1W-K |
| Temperature Sensor | Digital temperature sensor with 12 inch wire leads. Note: Leads may be extended -55°C to +125°C ($\pm 0.5^\circ\text{C}$ from -10°C to +85°C) | X-DTS-U |
| Temperature Sensor | Digital temperature sensor with 3 foot wire leads (housed in a water resistant stainless steel probe) -55°C to +125°C ($\pm 0.5^\circ\text{C}$ from -10°C to +85°C) | X-DTS-S3C |
| Temperature Sensor | Digital temperature sensor with 32 foot wire leads (housed in a water resistant stainless steel probe) -55°C to +125°C ($\pm 0.5^\circ\text{C}$ from -10°C to +85°C) | X-DTS-S32C |
| Water Leak Sensor | Water leak sensor | GRI-2605 |
| Spare Connector | 14-Pin Connector Plug | X-TERM14A |

1.4 Security Notes

The X-410 is a dedicated device and does not employ a general purpose computer operating system (i.e. Windows, Linux etc.) It does not have features such as telnet, SSH, nor uncontrolled open ports. This means it is extremely difficult, if not impossible, for someone to 'break in' to the X-410 and access other devices on your local network. The simplicity of the X-410 makes it an inherently secure device. Nevertheless, as with any device installed on a network, appropriate security precautions should be observed. Where security is concerned, access to the device should be limited to using encrypted connections to the web server server using HTTPS. Unencrypted access can be disabled in the Network setup page.

It is recommended that passwords be enabled for the *Administrators*, *Managers* and perhaps *Users*. Passwords should be at least 8 characters in length and use a combination of upper and lower case letters and numbers. For additional security, the X-410 includes an IP filter and can be used in conjunction with an external firewall to further limit access to selected IP addresses.

The firmware in the X-410 can be upgraded, but not over the internet. By design, a firmware upgrade requires physical access to the *Restore Defaults* button on the module. See Appendix B: Installing New Firmware.

1.5 Connectors & Indicators

I/O Connector

The X-410 has a 14-position removable screw terminal connector for making connections to the power source, relays, digital inputs and temperature/humidity sensors.

| Pin | Description |
|------|--|
| Vin+ | Power Supply VDC+ (9-28 VDC) DO NOT EXCEED MAXIMUM POWER SUPPLY VOLTAGE. |
| Gnd | VDC- (Ground) power supply input. |
| 1NO | Relay 1 Normally Open Contact |
| 2NO | Relay 2 Normally Open Contact |
| 3NO | Relay 3 Normally Open Contact |
| 4NO | Relay 4 Normally Open Contact |
| COM | Relay 1,2,3, and 4 Common Contact |
| In1+ | Positive side of the digital input 1. |
| In2+ | Positive side of the digital input 2. |
| In3+ | Positive side of the digital input 3. |
| In4+ | Positive side of the digital input 4. |
| Gnd | Ground connection for 5VDC output, digital inputs and the 1-Wire sensor(s) |
| Data | Data connection for digital sensor(s) on the 1-Wire bus. |
| +5VO | This output voltage is used to provide power for the digital sensor(s) on the 1-Wire bus. It can also be used as an excitation voltage for the digital inputs. |

Network Connector

The Ethernet connector is a standard, 8-position modular receptacle for RJ-45 connectors. The Ethernet port supports auto-negotiation and automatically selects the speed, duplex mode and works with straight or crossover cables.

Power Indicator

The green Power LED indicator is illuminated whenever the module is powered.

Relay Indicators

Four yellow LEDs illuminate when the corresponding relay is energized. When a relay is energized, the common and normally open contacts are closed.

Input Indicators

Four yellow LEDs illuminate when the corresponding digital input is on.

Ethernet Indicators

The LINK LED is illuminated green when the module is properly connected to an Ethernet network and is ready to communicate. Network communications will only occur if this LED is illuminated. The ACT LED flashes yellow when activity is detected on the network.

1.6 Accessing the X-410 using a Web Browser

The X-410 has a built-in web server that provides simple web pages that can be accessed directly using a standard web browser. This allows users to access the unit with NO SPECIAL SOFTWARE installed on their computer. This is ideal for applications that require a quick, simple solution that does not need to be accessible to more than a few people. This configuration is simple to setup, simple to use, and can be accessed from just about any computer or smart phone.

Note: Network routers may need to be configured to allow access from computers outside of the local network (see Appendix C: Accessing the X-410 Over the Internet.)

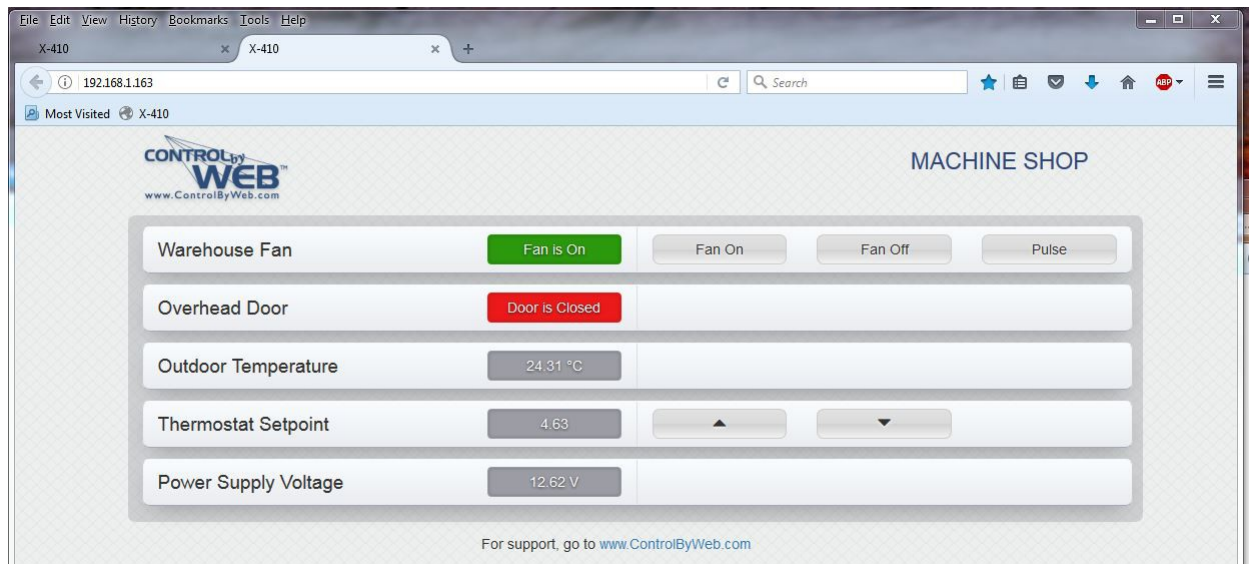

Section 2: Installation and Connections

Installation consists of mounting the X-410 and connecting it to an Ethernet network, providing power, connecting the relays, digital inputs, and 1-Wire sensors. The installation is completed by configuring the module using a web browser.

2.1 Installation Guidelines

- This unit must be installed by qualified personnel.
- This unit must not be installed in unprotected outdoor locations.
- This unit must not be used for medical, life saving purposes, or for any purpose where its failure could cause serious injury or the loss of life.
- This unit must not be used in any way where its function or failure could cause significant loss or property damage.
- Do not use to directly control motors or other actuators not equipped with limit switches or other safeguards to protect from equipment or wiring failures.
- The X-410 should be located in a clean, dry location where it is protected from the elements. Ventilation is recommended for installations where ambient air temperatures are expected to be high. See Appendix I: Mechanical Dimensions for additional mechanical details.
- If the X-410 is used in a manner not specified by Xytronix, the protection provided by the equipment may be impaired.

Wall Mounting

Mount the X-410 to a wall by using two #8 screws. Attach the screws to the wall vertically spaced exactly 2.5 inches apart. The head of the screw should be about 1/10 inch away from the wall.

DIN-Rail Mounting

The X-410 can be mounted to a standard (35mm by 7.55mm) DIN-Rail. Attach the X-410 to the DIN-Rail by hooking the top hook on the back of the enclosure to the DIN-Rail and then snap the bottom hook into place. To remove the X-410 from the DIN-Rail, use a flat-head screwdriver. Insert the screw driver into the notch in the release tab and pry against the enclosure to release the bottom hook.



2.2 Making Connections

CAUTION: Make sure the power is shut off before making connections

CAUTION: This unit should be installed by a qualified technician.

CAUTION: Miswiring or misconfiguration could cause permanent damage to the X-410, the equipment to which it is connected, or both.

A removable terminal connector is provided for making the power connections. To help protect the X-410 from mechanical stress remove the terminal connector before making the connections.

1. Make sure power is turned off.
2. Remove the terminal connector from the X-410 and make wiring connections to the terminals. This technique avoids stressing the internal components while torquing the screws.
3. Reconnect the terminal connector.
4. Apply power.

It is recommended that any load (device to be controlled) not be connected until after the X-410 has been configured and tested. By doing this, wiring and configuration mistakes will not cause the load device to turn on unexpectedly. Make certain the wires are properly inserted into to the terminals and that the screws are tight.

See Appendix D: Specifications for wire size, temperature rating and torque requirements for making connections to the terminal blocks.

Power Supply Connections

The X-410 requires power for its internal logic circuits. Connect a 9-28 VDC power supply to the +Vin and Vin- (Gnd) terminals. A regulated power supply is recommended, such as a wall-mount AC-DC adapter. Verify that the adapter is rated for the operating current of the X-410 (See *Appendix D: Specifications* for the current requirements.) Multiple X-410 units may be connected to a single power supply by connecting the power supply input terminals in parallel. The power supply must have an ample current rating to power all units connected.

The model X-410-E is normally powered from a Power Sourcing Equipment (PSE) device which passes DC power along with data on the twisted pair Ethernet cabling. This allows a single cable to provide both the data connection and DC power. With the X-410-E no connections are needed to the Vin+ and Vin- terminals. The Vin+ and Vin- (Gnd) terminals however, can be used as a backup power source. The X-410-E has an internal “diode or” circuit between the Vin+ terminal and the internal Powered Device (PD) circuits. If a power supply is connected to the Vin+ terminal, the X-410-E will draw power from the PSE if the input voltage is less than 12.0V, and from the Vin+ terminal if the input voltage is greater than 12.0V. If the PSE power fails, the X-410-E will draw all power from the Vin+ terminal.

2.3 Relay Connections (Control a device over an IP network)

The relay contacts are internally connected directly to the terminal connector. A Normally Open contact is provided for each relay. All relays share the same Common contact. The relay contacts may be wired in series with the power source for the load (device to be controlled) as long as the load does not exceed the maximum current and voltage rating of the relay contacts. When connecting multiple relays, make certain the common for all loads can be connected together without causing damage or a short circuit.

Note: For loads greater than 1 Amp, an external interposer relay should be used. The illustration below shows how a 15-Amp motor can be controlled using an external relay. In the example, the X-410 controls the external relay and the external relay controls the load.

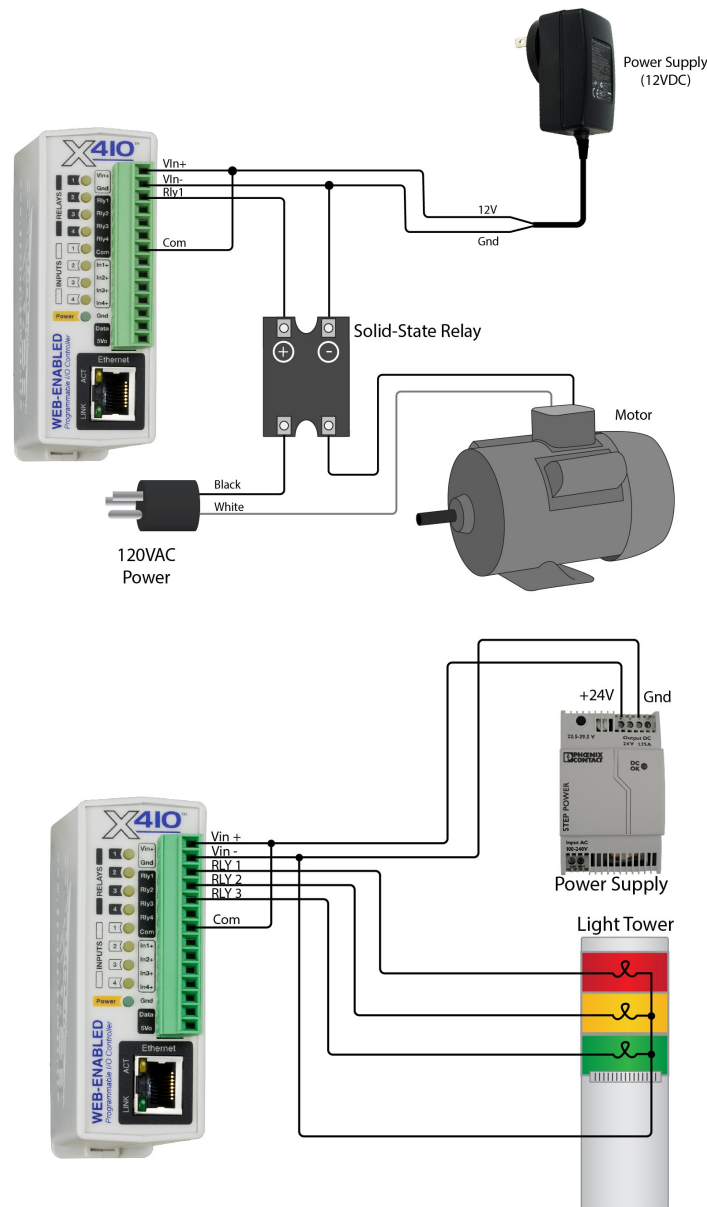

When mechanical relays switch inductive loads such as motors, transformers, relays, etc., the current will arc across the internal relay contacts each time the contacts open. Over time, this causes wear on the relay contacts which can shorten their life span. When switching an inductive load, it is recommended that relay contact protection devices are used.

Note that the X-410 does not provide relay contact protection in order to provide the greatest versatility and because appropriate protection differs for various loads. Below is an example of relay contact protection for a DC circuit and an AC circuit. For component values required to provide sufficient contact protection for your application, refer to appropriate references.

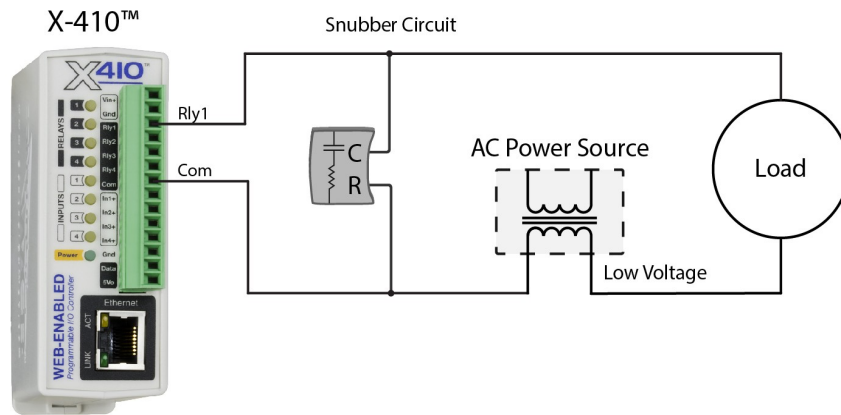
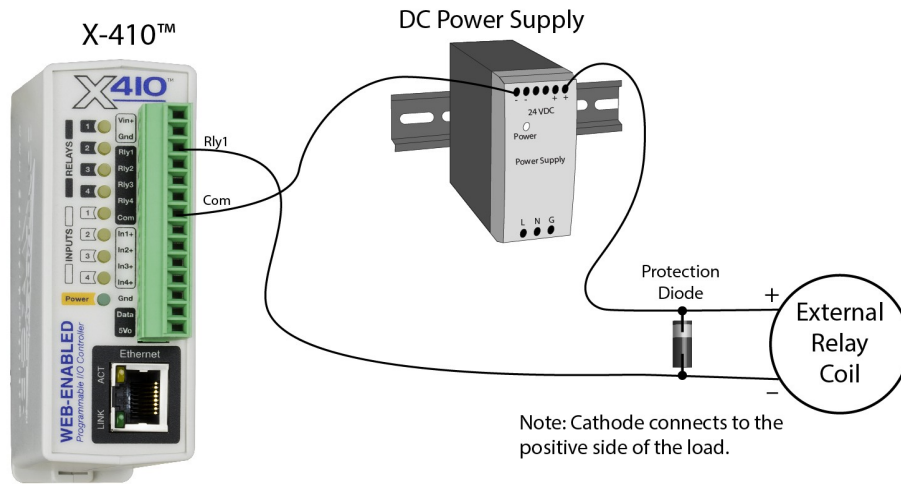

2.4 1-Wire Sensor Connections

The X-410 has a 1-Wire port which supports up to 16 digital sensors for measuring temperature, humidity and more.

The sensors share the same three connections for communications and power (+5V, Ground, Data). Every sensor on the bus is assigned a unique serial number when it is manufactured. That number is used to address the sensor during communication.

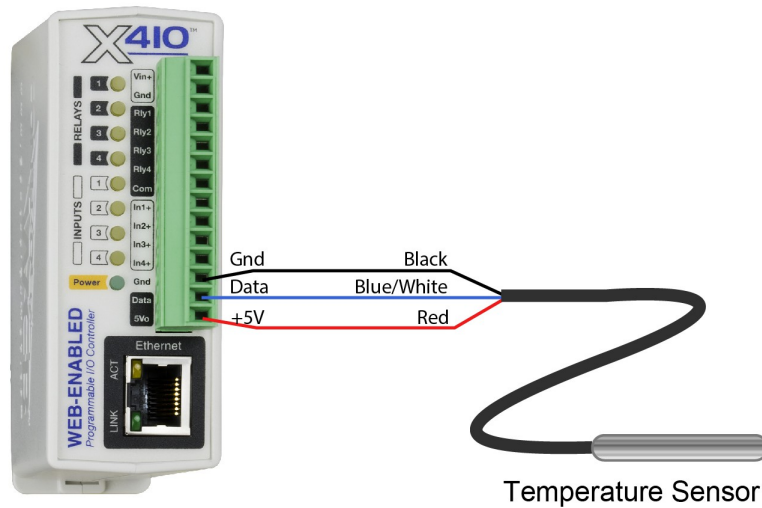

The digital temperature sensors are interchangeable and require no calibration. See *Optional Accessories* for a list of compatible 1-Wire sensors. The X-DTS-U and X-DTS-S3C temperature probes shown below have a measurement range of -67°F to +257°F (-55°C to +125°C) and an accuracy of +/- 0.5°C (-10°C to +85°C). The X-DTS-S3C has a stainless steel probe and can be used in unprotected outdoor locations however, the probe is not suitable for immersion or use in pressure vessels. For immersion and other demanding applications use a thermowell to protect the sensor. The X-DTS-U sensor is used in protected locations. The temperature sensors have three wires as shown below.

| Sensor Wire Color | Connection |
|---------------------|------------|
| Red | +5V |
| Black | Gnd |
| Blue, White, Yellow | Data |

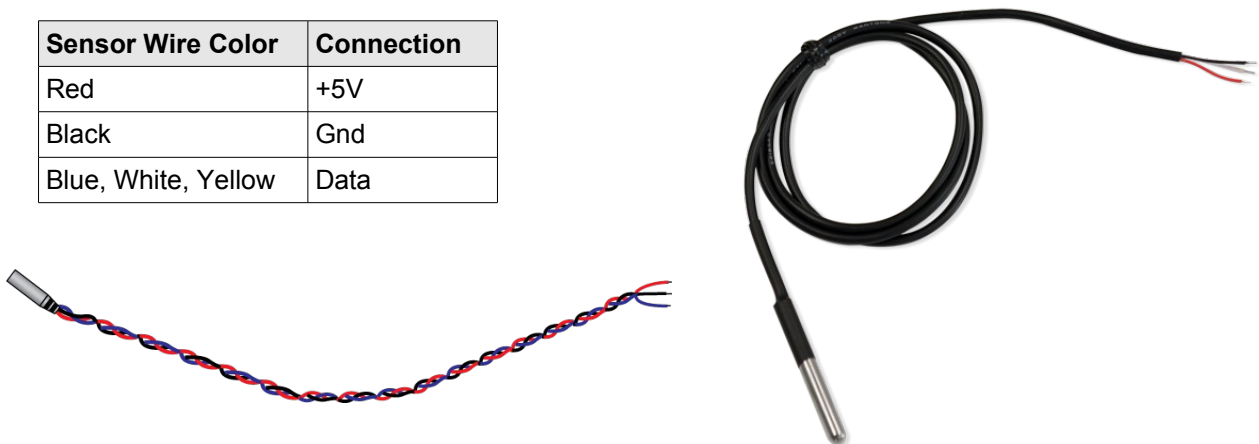

Multiple sensors can be connected in two ways: directly connected (star topology) or “daisy chained” (linear topology). Many factors can determine the maximum length of the cable, including the sensor network topology, the type of cable used, the number of sensors and ambient electromagnetic noise. Combined cable lengths to all sensors of 600 ft using Cat 5e cable have been successful. However, due to the uniqueness of installation environments, results may vary. Please test in the desired environment before making a permanent installation.

The following are general recommendations that will maximize sensor runs and minimize problems. Cat 5 and Cat 5e network cables have proven to be an effective and low-cost solution for long runs. Other cable types can be used, but cable capacitance generally limits the length. The illustration shows the recommended connection using a Cat 5 network cable. Connect all unused conductors to ground.

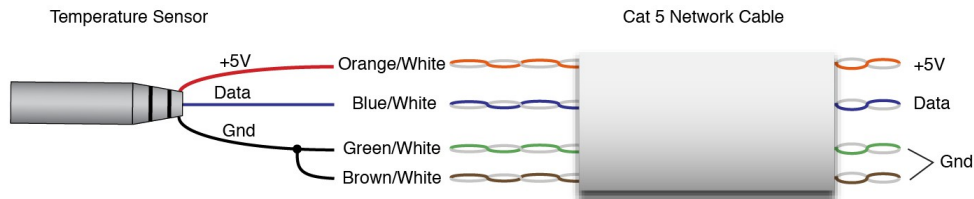

Recommended connections using Cat5 cable

A linear (daisy chain) topology will minimize signal reflections, providing a more reliable connection and will allow a longer cable length than a star topology.

The 1-Wire bus is "single-ended" and has no intrinsic noise protection. It is susceptible to interference if the cable is routed near power lines, fluorescent fixtures, motors or other noise sources. Keep the cable wiring short and avoid routing it near other electrical equipment.

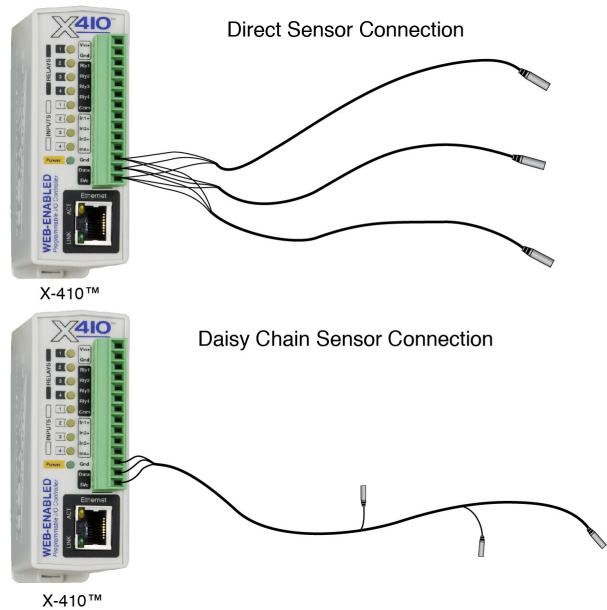

2.5 Digital Input Connections

The digital inputs can be used to control the internal relays, control remote relays (over the network), or simply to monitor the state of a discrete device. To use these inputs, connect a DC control voltage directly to the input and ground, and set up the function of the input using the configuration pages. A current limiting resistor is provided internally, so no external resistors are required as long as the maximum input voltage is not exceeded. If an AC signal, or a signal greater than the rated input voltage needs to be detected by the X-410, use a signal conditioner to convert the signal to a DC signal within the input range. With the X-410, the digital inputs are not isolated and share a common ground with the power connection.

2.5.1 DC Input Connections

Each digital input is connected internally through a current-limiting resistor directly to a photo-coupler circuit. The photo couplers are tied to the Gnd terminal of the X-410 and are not isolated. No external resistor is necessary as long as the input signal is within the proper range (*See Appendix D: Specifications*). A DC voltage can be reduced with an external resistor of the appropriate value and power rating to reduce the input current.

The digital input has an internal 3K ohm resistor. The forward voltage drop of the photo-coupler is approximately 1.2V and works well with an input current of 9mA. Use the following formula to determine the resistor value needed for other voltage ranges:

$$R = ((V_{in} - 1.2) / 0.009) - 3000$$

Where:

- R = External resistor value required
- V_{in} = Desired input voltage
- 1.2V = forward voltage drop of the LED in the photo coupler
- .009A = workable LED current
- 3000 ohm = Internal resistor

For example:

To connect a 48VDC signal voltage to the X-410:

$$R = ((48 - 1.2) / 0.009) - 3000 = 2200 \text{ ohms}$$

Check the power dissipated by the resistor:

$$P = I \times I \times R, \text{ The resistor must be at least } .009 \times .009 \times 2200 = 0.18 \text{ Watts, so use a } 1/2 \text{ Watt resistor.}$$

2.5.2 Switch-Closure Connections

The X-410 can sense the state of a switch-closure sensor. Sensors with switch-closure outputs include push buttons, magnetic door alarm switches, micro-switches, or any device which has a relay, switch-closure or open-collector output. The X-410 can be configured for the alarm to be active when the switch is either open or closed.

The illustration below shows an example of using the X-410 to monitor the status of a gate or door over an IP network. The status of the device is detected with a switch. These types of sensors are called “dry contacts” in that the sensor output is a bare switch with no power source. In this example the voltage source for the switch is provided via the +5V output.

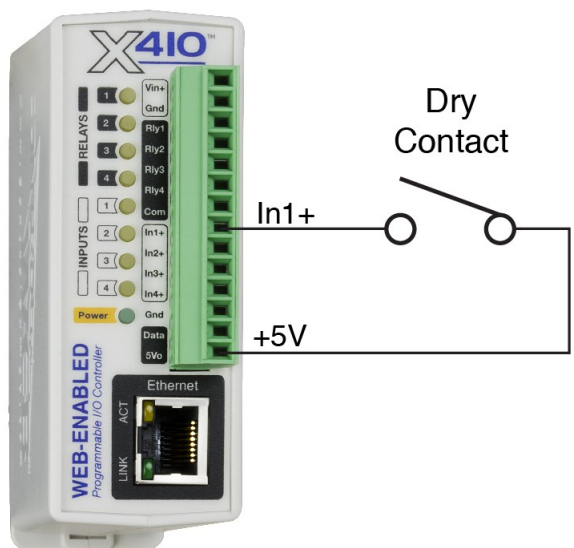

2.5.3 Water Leak Sensor Connections

A GRI-2605 water leak detector can be directly connected to the X-410. The sensor detects the presence of water or other conductive liquids. The sensor has 4-wires which are connected as shown below. The GRI-2605 has an internal relay whose contacts (green & white wires) are closed when the sensor is dry. When the sensor is dry the digital input will be "On". When water is detected, the relay contacts open and the digital input will be "Off". With the connections shown, the sensor is a supervised alarm circuit such that if a wire is disconnected or the sensor fails, an alarm will be generated. The X-410 can be programmed to activate its relay, activate a relay at a remote location, and send an e-mail warning when a water leak is detected. After installation, test the sensor with a damp sponge or wet towel.

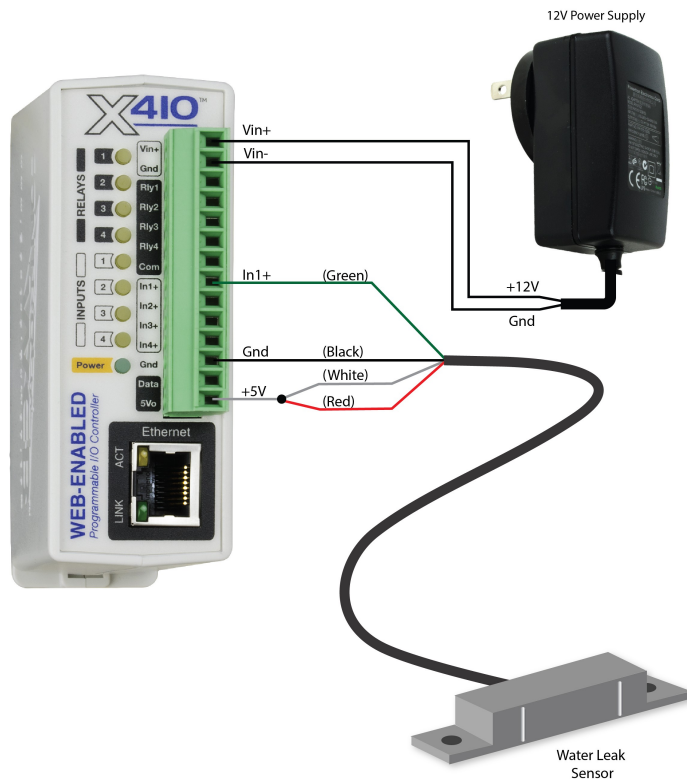

2.5.4 AC Input Connections

If an AC signal voltage needs to be detected, use a signal conditioner to convert the AC signal to a DC voltage within the input range. An AC signal conditioner can be made using a diode (or bridge rectifier) and a capacitor. Prepackaged signal converters are available as accessories at industrial automation distributors.

A simple voltage converter module (RedLion VCM10000 or VCM20000) is shown below. These are available in two input voltage ranges that cover the range from 4-270VAC/DC. These devices have a MOSFET output (solid state DC contact closure) which is compatible with the X-410 input. The converter module accepts AC (50/60 Hz) or DC voltages with an input pulse rate up to 30 Hz. The converter provides isolation between the input and output using an opto-isolator. You must provide a voltage source for the converter circuit as shown in the example below:

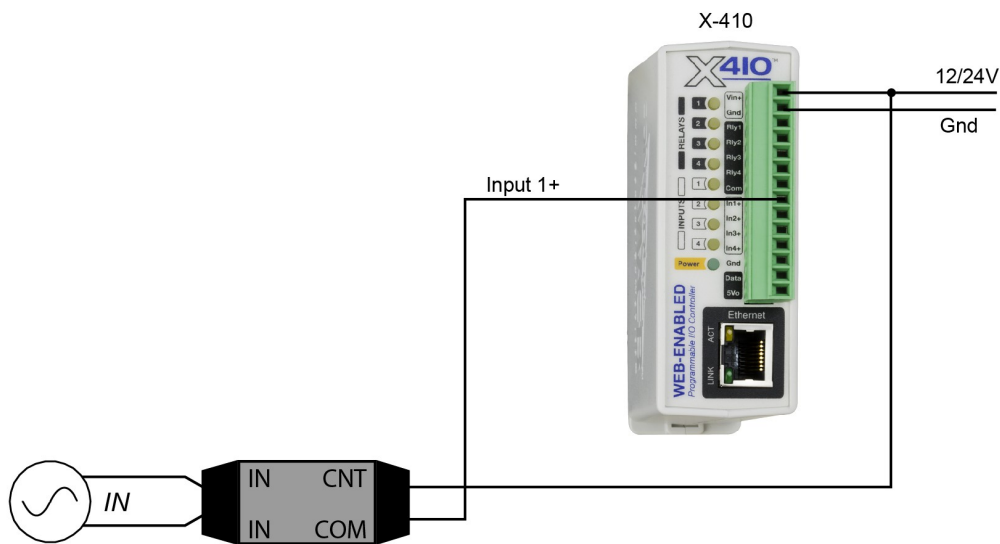

2.5.5 Network Connection

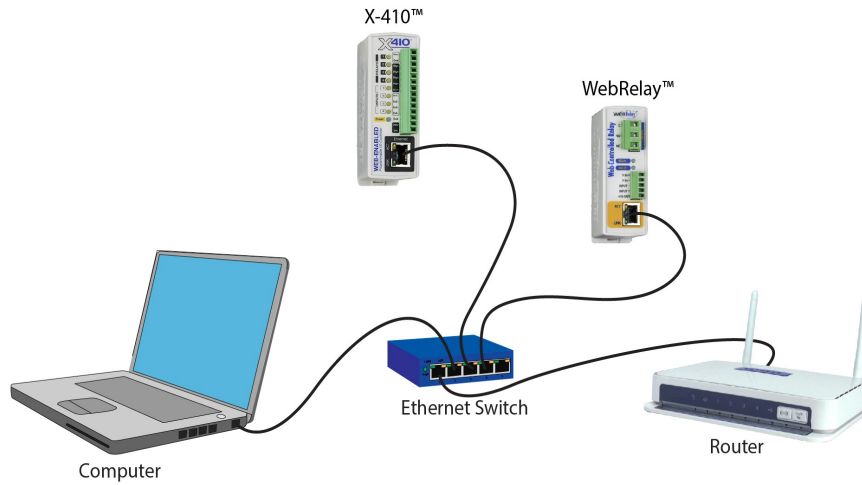

Connect the Ethernet port to a standard 10/100/1000 Base-T Ethernet connection. The X-410 typically connects to an Ethernet switch, or router. For configuration, X-410 may be connected directly to the Ethernet port on a computer or through a switch or router. The X-410 supports auto negotiation and will work with either crossover or straight-thru cables. The X-410 can be used on a wireless network by connecting through an Ethernet bridge or a wireless router.

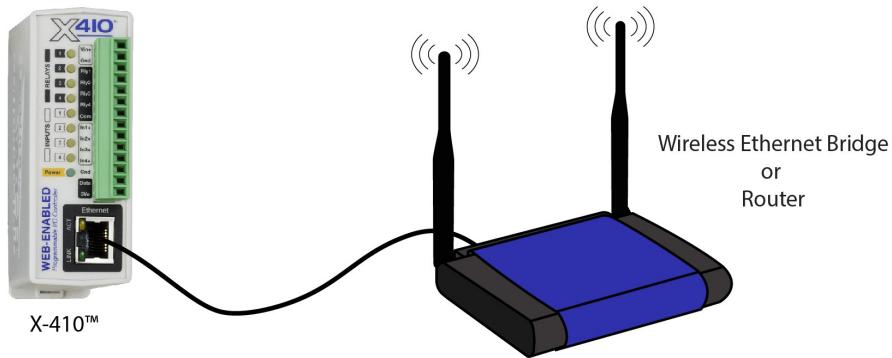

Note: The wireless Ethernet bridge or router must be properly configured for the wireless network. Refer to the installation instructions for the wireless device.

2.6 Establishing Communications for Setup

In order to configure the X-410 with the web browser interface, the X-410 must be connected to an Ethernet network. This can be done by one of two methods:

Method 1– Temporarily change the IP address of a connected computer to be compatible (same subnet) with the default IP address used by the X-410.

-or-

Method 2 – Assign a temporary IP address to the X-410 to work on an existing network.

Note: If multiple ControlByWeb™ products are used on the same network, install one at a time and set the IP address of each unit before connecting the next unit to the network. This avoids having multiple devices being installed on the network with the same factory default IP address at the same time. If this approach is used, be sure to clear the arp cache after disconnecting each unit (run 'arp -d' from an administrative command prompt).

2.6.1 Method 1: Assign a Temporary IP Address to the Configuration Computer

By default, the X-410 comes from the factory with an IP address of 192.168.1.2. Communication with the X-410 may be established by assigning an IP address to the configuration computer so that it is on the same network as the X-410 (for example, the configuration computer could be assigned to 192.168.1.50)

The following example is for those running the Windows-8 operating system:

1. Apply Power, wait 15 seconds for the X-410 to become operational, and then connect the Ethernet cable.
2. Open the Windows 8 start screen.
3. Type “Control Panel” and press enter (the search box opens automatically when you begin typing).

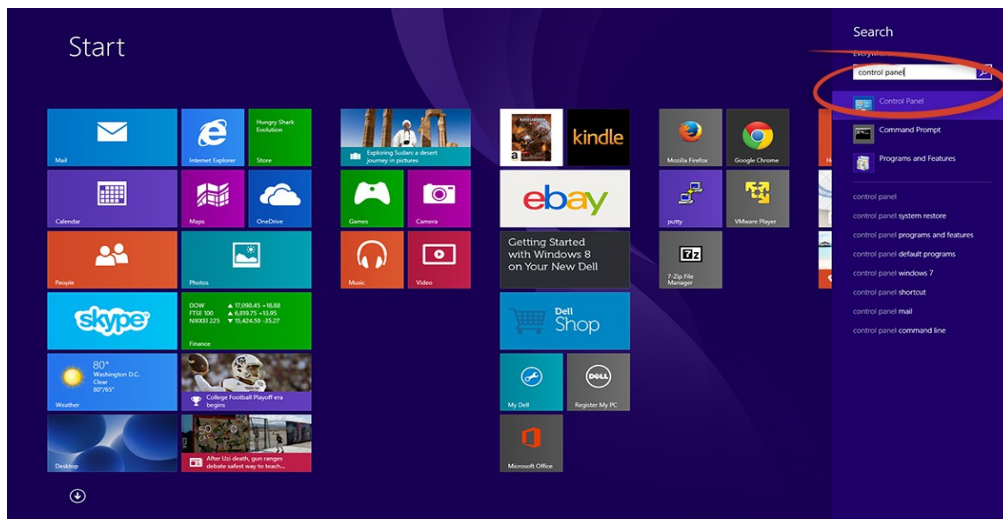

4. Select *View network status and tasks*.

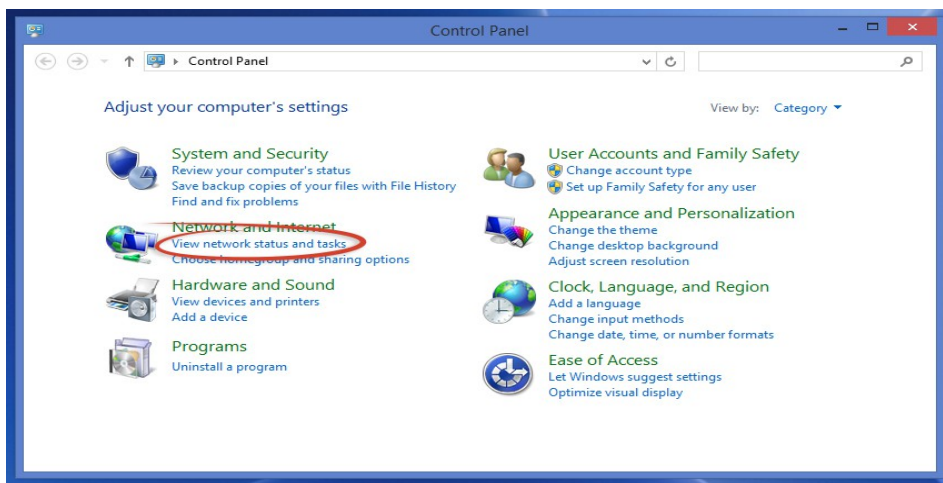

5. Select *Change adapter settings*

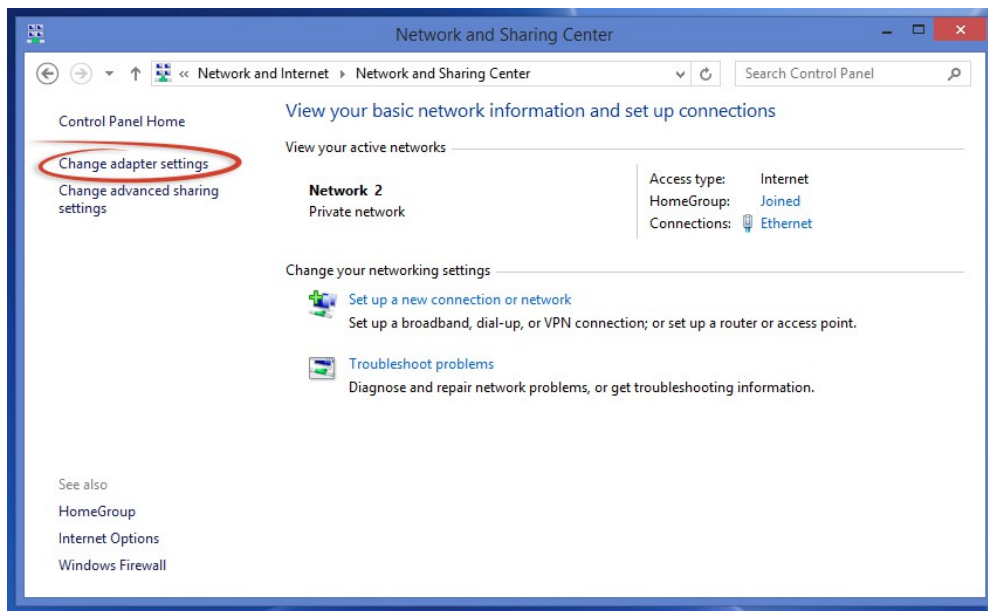

6. Your machine may have more than one Internet connection shown. Right-click on the adapter for your connection to the Internet. A drop-down box will appear, choose *Properties* to view/edit the settings for this internet connection.

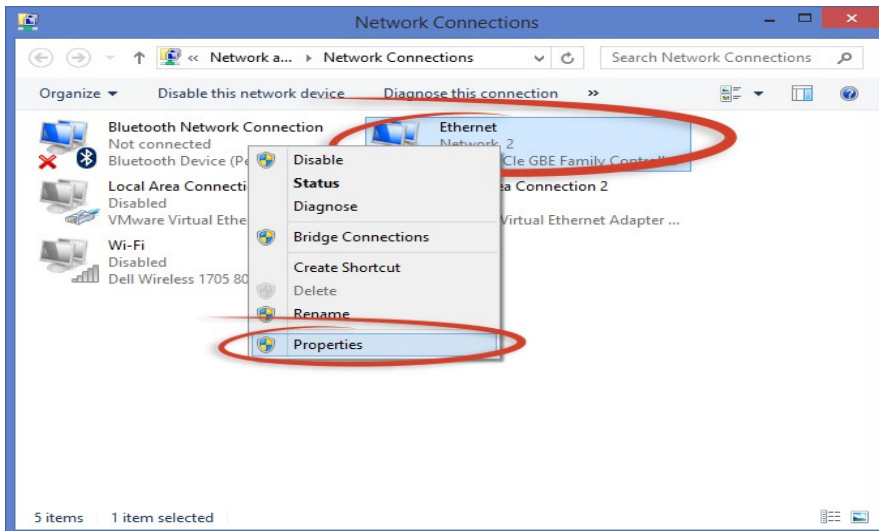

7. Select *Internet Protocol Version 4 (TCP/IPV4)* and then click the *Properties* button.

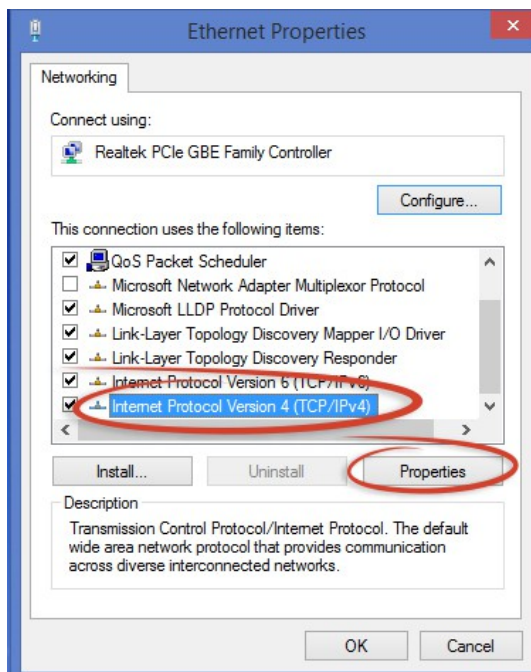

8. If "Use the following IP address" is already selected, the computer has been setup with a static IP address. Record these values so that the current IP address of the computer can be restored once the IP address of the X-410 has been successfully changed.

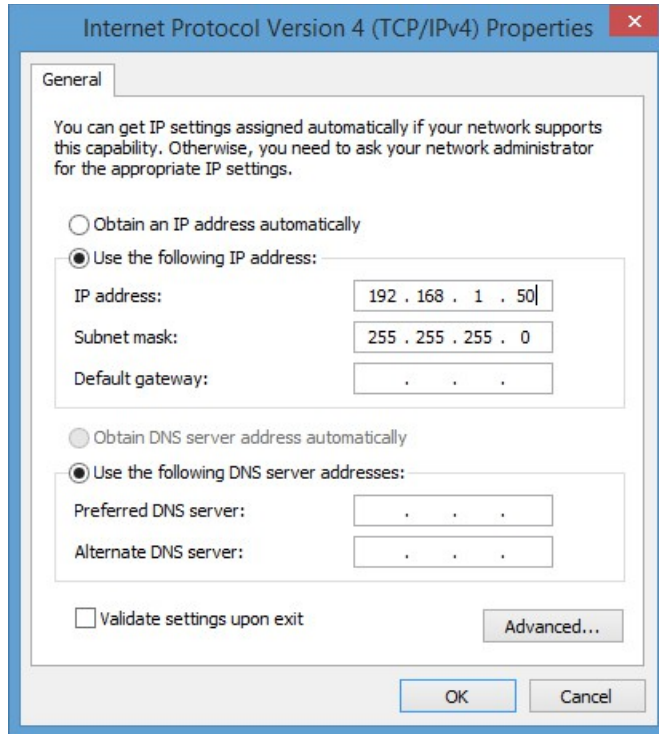

Select the radio button labeled "Use the following IP address" and type in the IP address:

192.168.1.50

Type in the subnet mask:

255.255.255.0

No need to change the default gateway field. Click *OK* to accept the new settings.

9. Open the setup pages by entering the following URL in the address bar of a web browser:

`http://{ipaddress}/setup.html`

(For example: `http://192.168.1.2/setup.html`)

If the setup pages are not accessible, verify that the X-410 is powered on and that the LINK light is illuminated. Check all network connections and settings.

Another way to check communications is to ping the X-410 from the command prompt by typing:

`ping [ipaddress] (e.g. ping 192.168.1.2)`

2.6.2 Method 2: Assign a Temporary IP address to the X-410

This option (arping) is used to TEMPORARILY assign an IP address to the X-410 without the need to change the IP address of the configuration computer. The X-410 will use this IP address as long as power is maintained. Once power is lost, the X-410 will use the IP address assigned in the setup page and not the temporary address assigned here. Make sure that the X-410 and the configuration computer are connected to the same network. Since ARP is non-routable, this will not work through routers or gateways.

Microsoft Windows Instructions

1. Open a Command Prompt (select START, then RUN, then type "cmd").

Note: For Vista, 7, 8, and 8.1, the Command Prompt should be run as administrator (select Start, then type "cmd" and right click on "cmd" and select "Run as administrator").

2. Type:

```
arp -s {new IP address} {serial number of the X-410 }
```

Note: IP address format is xxx.xxx.xxx.xxx. The serial number can be found on a label on the module board. The format is ss-ss-ss-ss-ss-ss.

For example, to set the X-410 (with serial number 00-0C-C8-01-00-01) to 10.10.10.40 the following command would be used:

```
arp -s 10.10.10.40 00-0c-c8-01-00-01
```

3. Next, type:

```
ping -l 102 {new IP address}
```

For example, if the new IP address is 10.10.10.40, the following command would be used:

```
ping -l 102 10.10.10.40
```

4. Proceed with the X-410 setup in *Section 3*.

Once setup is complete, it may be necessary to clear the 'arp' cache to configure additional devices. This is necessary because each unit has the same default IP address, but a different unit serial number (MAC address). Clearing the arp table can be done by typing `arp -d` in the command prompt window.

Linux/Unix Instructions

1. Open a terminal and change to root user (su -, then enter root password).

2. Type:

```
arp -s {new IP address} {serial number of the X-410 }
```

Note: IP address format is xxx.xxx.xxx.xxx. The serial number can be found on a label on the module board. The format is ss:ss:ss:ss:ss:ss.

For example, to set the X-410 (with serial number 00-0C-C8-01-00-01) to 10.10.10.40 the following command would be used:

```
arp -s 10.10.10.40 00:0c:c8:01:00:01
```

3. Next, type:

```
ping -s 102 {new IP address}
```

For example, if the new IP address is 10.10.10.40, the following command would be used:

```
ping -s 102 10.10.10.40
```

4. Proceed with the X-410 setup in *Section 3*.

Once setup is complete, it may be necessary to clear the 'arp' cache to configure additional devices. This is necessary because each unit has the same default IP address, but a different unit serial number (MAC address). Clearing the arp table can be done by typing `sudo arp -d -a` in the command prompt window.

Mac OS X Instructions

1. Open a terminal.

Note: The terminal is in the "Utilities" directory, which is in the "Applications" directory.

2. Type:

```
sudo arp -s {new IP address} {serial number of the X-410 }
```

Administrator password may be required.

Note: IP address format is xxx.xxx.xxx.xxx. The serial number can be found on the label on the module board. The format is ss:ss:ss:ss:ss.

3. For example, to set the X-410 (with serial number 00-0C-C8-01-00-01) to 10.10.10.40 the following command would be used:

```
sudo arp -s 10.10.10.40 00:0c:c8:01:00:01
```

4. Next, type:

```
ping -s 102 {new IP address}
```

For example, if the new IP address is 10.10.10.40, the following command would be used:

```
ping -s 102 10.10.10.40
```

5. Proceed with the X-410 setup in *Section 3*.

Once setup is complete, it may be necessary to clear the 'arp' cache to configure additional devices. This is necessary because each unit has the same default IP address, but a different unit serial number (MAC address). Clearing the arp table can be done by typing `sudo arp -d -a` in the command prompt window.

Section 3: Web Server and Setup Pages

The internal web server presents two classes of web pages; *Setup* pages and *Control* pages. *Setup* pages are used by an installer to provision and configure the X-410. The *Control* page allows the relays to be controlled and displays temperature and digital input status information.

To access the *setup* pages, enter the following URL in the address bar of a web browser:

```
http://{ipaddress}/setup.html
```

For example, using the default IP address, enter:

```
http://192.168.1.2/setup.html
```

To access the *control* page, enter the following URL in the address bar of a web browser:

```
http://192.168.1.2
```

To access any web pages over an encrypted connection replace http with https. For example:

```
https://192.168.1.2/setup.html
```

```
https://192.168.1.2
```

Before accessing any setup page, the browser will request a username and password. The X-410 supports various levels of user authentication with different permissions to the setup pages. For a description of *Administrators*, *Managers* and *Users* see *Section* General Settings Tab > PASSWORDS. The *Administrator* username is `admin` and the default password is `webrelay` (password is case sensitive).

The setup pages are divided into six sections. Sections with a ▼ symbol can be expanded to reveal other related settings. When using the setup pages, you must click the *Submit* button at the bottom of a page if you have made changes to a setting on the page.

3.1 Setup Strategy

To configure the X-410, first update the Network tab settings to make the X-410 accessible on your network and configure the Gateway and DNS Server IP Addresses. (The power must be cycled for these settings to take effect.) Setup any email addresses that will be needed for alarms and messages.

Next, name and define the resources under the I/O Setup menu (relays, digital inputs, 1-Wire sensors, registers and timers.) For example, change the name of “Relay-1” to something descriptive such as: “Exhaust Fan”. Once the resources are named, define any control logic (tasks) or Basic scripts under the Control/Logic menu. Finally, setup and configure the Control Page under Monitor & Control to show the information and control buttons needed for your specific application.

Finish by viewing and testing the Control Page, monitor your relay and sensor display and experiment with any buttons or controls. Test for proper operation of email messages and alarms.

3.2 General Settings Tab

The General Settings tab is a collection of menus for configuring the X-410 and its services. The IP network settings, email server settings and device configuration backup and restore features are grouped under this menu.

3.2.1 General Settings Tab > GENERAL INFORMATION

This is the initial page that is displayed when setup.html is entered into the address bar of the browser. It displays the part number, firmware revision, and serial number of the unit. The optional latitude and longitude settings are used for calculating sunrise and sunset times for Scheduled Tasks. A global setting selects the temperature units.

The screenshot shows the 'GENERAL INFORMATION' section of the 'GENERAL SETTINGS' page. It contains the following fields and values:

- Part Number: X-410-I
- Firmware Revision: 0.09
- Serial Number: 00:0C:C8:00:00:00
- Vin Voltage: 13.29 V
- Internal 5V Voltage: 4.95 V
- Latitude: 41.6796
- Longitude: -111.8737
- Temperature Units: Fahrenheit (selected), Celsius, Kelvin

At the bottom right, there are 'Submit' and 'Cancel' buttons.

Part Number

This displays the full model number of the module.

Firmware Revision

This is the current product revision of the unit's firmware.

Serial Number

This is the serial number of this unit. The serial number is also the MAC address of the unit.

Vin Voltage

This is the voltage on the +Vin power input terminal. If the module is powered from a battery, this value will show the battery voltage. With the X-410-E the power is provided over the Ethernet cable and the Vin+ monitor will show POE unless a voltage of at least 9VDC is supplied on Vin+.

Internal 5V Voltage

This diagnostic displays the voltage of the internal 5V power rail. It should be 5.0V \pm .25V. If it is low, check for overload conditions on the 1-Wire bus.

Latitude & Longitude

The optional latitude and longitude settings are used for calculating sunrise and sunset times for *Scheduled Tasks*.

Temperature Units

This global setting sets the temperature units of *Fahrenheit*, *Celsius*, or *Kelvin* for all temperature sensors, both local and remote.

3.2.2 General Settings Tab > NETWORK SETTINGS

The network parameters are set on this page. Configure the network settings to make the X-410 accessible on your network. **The X-410 must be power-cycled (power disconnected, then reconnected) before new network settings take effect.**

The screenshot shows the 'NETWORK SETTINGS' page within the 'GENERAL SETTINGS' section. The page title is 'NETWORK SETTINGS' with a gear icon. Below the title, a note states: 'The following network settings will require reboot to take affect.' The settings are as follows:

| | |
|-----------------------|---|
| Use DHCP: | <input type="radio"/> Yes <input checked="" type="radio"/> No |
| IP Address: | <input type="text" value="192.168.1.2"/> |
| Subnet Mask: | <input type="text" value="255.255.255.0"/> |
| Gateway: | <input type="text" value="192.168.1.1"/> |
| Preferred DNS Server: | <input type="text" value="192.168.1.1"/> |
| Alternate DNS Server: | <input type="text" value="192.168.1.1"/> |
| HTTP Port Enabled: | <input checked="" type="radio"/> Yes <input type="radio"/> No |
| HTTP Port: | <input type="text" value="80"/> |
| HTTPS Port: | <input type="text" value="443"/> |
| MTU: | <input type="text" value="1476"/> |

At the bottom of the form, there are two buttons: 'Upload/View SSL Certificate' and 'Upload/View SSL Key'. At the very bottom, there are 'Submit' and 'Cancel' buttons.

Use DHCP

This option allows DHCP to be enabled or disabled. If this option is set to *Yes*, the X-410 will request an IP address from the DHCP server each time it is powered on. The default setting is *No* (this is recommended for most installations). If DHCP is set to *Yes*, the Network page must be submitted and the X-410 must be rebooted before an IP address will be assigned. Once the X-410 is assigned an IP address by the DHCP server, the new IP address can be found through the list of clients kept by the DHCP server (for most instances, the DHCP server is in the local gateway or router).

Brief Notes About DHCP: All devices on an IP network require an IP address. This is a unique address that identifies each device on the network. DHCP (Dynamic Host Control Protocol) is a mechanism that automatically assigns an IP address to a computer (or other device) when it is connected to a network. This eliminates the need to manually enter the IP address. When a computer is connected to the network, another device on the network called a DHCP server detects the presence of the computer or device and dynamically assigns an IP address. On many small networks, the DHCP server is built into the router.

DHCP works well for "client" devices such as computers, but is not ideal for servers. This is because servers usually don't initiate communications with other devices, but rather they wait for a request

from "clients." To make this request, the client must know the IP address of the server. If a server gets its IP address dynamically, the IP address may not always be the same so client devices may not be able to find the server. For this reason, servers usually use an IP address that is fixed and does not change. The X-410 is a server and manual IP address assignment is usually recommended.

IP Address

Enter the IP address for the X-410 in this field. The IP address is specific to the network where the X-410 will be installed, and must be obtained from the network administrator. For more information on IP addresses and remotely accessing the X-410 over the Internet, see *Appendix C: Accessing the X-410 Over the Internet*. The default setting for this field is 192.168.1.2.

Subnet Mask

The subnet mask defines the size of the local network. This can be obtained from the network administrator. For additional information about sub-netting and IP networking, many tutorials are available on the Internet. The default setting for this field is 255.255.255.0.

Gateway

This specifies the IP address of the gateway router. This can be obtained from the network administrator. The default setting for this field is 192.168.1.1.

Preferred DNS Server:

The IP address of the Primary DNS server is specified here. When DNS services are required, this is the address that will be used. The default setting for this field is 192.168.1.1.

This field is only required when the following options are used:

| | |
|---|---|
| Remote Services | When server is specified by name and not IP address. |
| Sync time clock with remote NTP server | When server name is specified by name and not IP address. |
| Email Server | When server name is specified by name and not IP address. |
| SNMP Manager | When the server for receiving traps and notifications is specified by name and not an IP address. |
| Remote Devices | When remote device (such as for use as a remote relay) is specified by name and not IP address. |

Alternate DNS Server

This field is used to specify the IP address of a Secondary DNS server. This is used when the X-410 requires DNS services and the preferred DNS server is not available. The default setting for this field is 192.168.1.1.

HTTP Port Enabled

This option enables or disables access to the web server without encryption. For high security applications the HTTP port should be disabled to limit access to only encrypted connections on the HTTPS port.

HTTP Port

The TCP port used for unencrypted HTTP communications with the X-410 is specified here. The default setting for this field is 80, which is the standard HTTP port. It is recommended that the port be left unchanged unless the user has an understanding of TCP/IP and ports. For more information on TCP ports and IP addressing see *Appendix C: Accessing the X-410 Over the Internet*.

HTTPS Port

The TCP port used for encrypted HTTPS communications. It is recommended not to change this port. When requesting a web page using <https://192.168.1.2/setup.html>, the web browser will automatically use port 443. If this port is changed to 9000 for example, the https port will have to be specified in the request <https://192.168.1.2:9000/setup.html>.

MTU

MTU is the Maximum Transmission Unit network parameter. This defines the max size, in bytes, of the TCP packets sent out from the device. The valid range is 256 to 1476 bytes. This normally can be left alone, but there are some circumstances where it might be beneficial to change it. One of these circumstances is when the device is to be used over a VPN (virtual private network). VPN's add extra information to TCP packets, if the new packets are too big to physically travel across the network (greater than about 1500 bytes) then the packets will be split up. This causes problems for some firewalls and those firewalls will discard the packets. To fix this, the MTU can be adjusted until the TCP packets do not get split up.

Upload/View SSL Certificate

By default, the X-410 comes with a previously generated SSL Certificate that is used for encrypted HTTP communications. The default SSL Certificate can be replaced by clicking on this link, choosing the new Certificate file (PEM format), and uploading the file. SSL Certificates are preserved through resetting defaults and updating firmware.

Upload/View SSL Key File

By default, the X-410 comes with a previously generated SSL Key that is used for encrypted HTTP communications. The default SSL Key can be replaced by clicking on this link, choosing the new Key file (PEM format), and uploading the file. The SSL Certificates are preserved if the firmware is updated or the module is reset to its default settings.

3.2.2.1 Hidden Network Setting

Remote Reboot

To cause the device to reboot, the following command can be entered into the address bar of the browser http://192.168.1.2/network.srv?spc0_rbt=1. The username and password will be requested before the reboot will occur so only administrators of the device can cause the reboot. This feature is useful for rebooting the device after changing the network settings if the device is located remotely. Changing the network settings and then rebooting the device can cause the device to become inaccessible if the network settings aren't correct. Make sure the network settings are correct before doing a remote reboot.

3.2.3 General Settings Tab > **ADVANCED NETWORK SETTINGS**

MODBUS

MODBUS/TCP Service can be enabled or disabled. Modbus is a messaging structure protocol used in industrial manufacturing control and automation. It is an open protocol and offers interoperability with software and devices from other manufacturers. This is enabled by selecting *Yes* in this field. The default setting for this field is *No*. (See *Section Modbus/TCP* for more information on using the X-410 on a Modbus network.)

Note: Modbus communications are disabled whenever the User password is enabled because Modbus/TCP does not provide a mechanism for password protection.

The X-410 functions as a Modbus slave. Host devices, such as PLCs, open a connection with the X-410 on port 502 and then send requests to read or set relay states, read input states, or sensor values. When the X-410 receives a command, it performs the desired function and returns a response.

Modbus Port

This specifies the port used for Modbus/TCP communications with the X-410. By default this is set to port 502 which is the standard Modbus port. It can be set within the range of 1 to 65535.

Endianness

32-bit data is treated as two individual 16-bit words using IEEE 754 floating point format. Floating point format is used for the sensors, pulse counters and for setting the output pulse duration. If *Big* is selected, the X-410 will use big-endian architecture, and the most significant 16-bit word (big end) is sent first. If *Little* is selected, then the X-410 will use little-endian architecture, and the least significant 16-bit word (little end) is sent first. The default setting is *Little* (little-endian). For example, in little-endian format, a 32-bit floating point number represented by '1234 ABCD' is sent as 'ABCD 1234'.

Modbus Address Table

The X-410 has a default Modbus address table with addresses for the relays, digital inputs, Vin and other fixed resources. As dynamic resources such as 1-Wire sensors, Registers, and remote I/O are

added, additional Modbus addresses are automatically created. Use this tool to view the current Modbus address assignments. The addresses are assigned when the I/O is added and cannot be customized except by deleting the I/O and changing the order in which they are added.

To interpret the Modbus Address Table, find the I/O resource in the left-most column. Then follow the line across to the column of interest. All I/O resources have a corresponding holding register pair for reading the values. This holding register address is listed in the *IO* column of the table and is interpreted as a IEEE-754 floating point value. The number in the cell is the modbus address for the given data type (or starting address in the case of floating point numbers). On the X-410, all holding registers are read and written as pairs. This is because Modbus registers are 16-bits wide and the data types for reading the registers are floating point and require 32-bits. The number listed in the table is the starting address and the corresponding register immediately follows it.

This example table shows the Modbus addresses of the X-410's resources and several configured 1-Wire sensors.

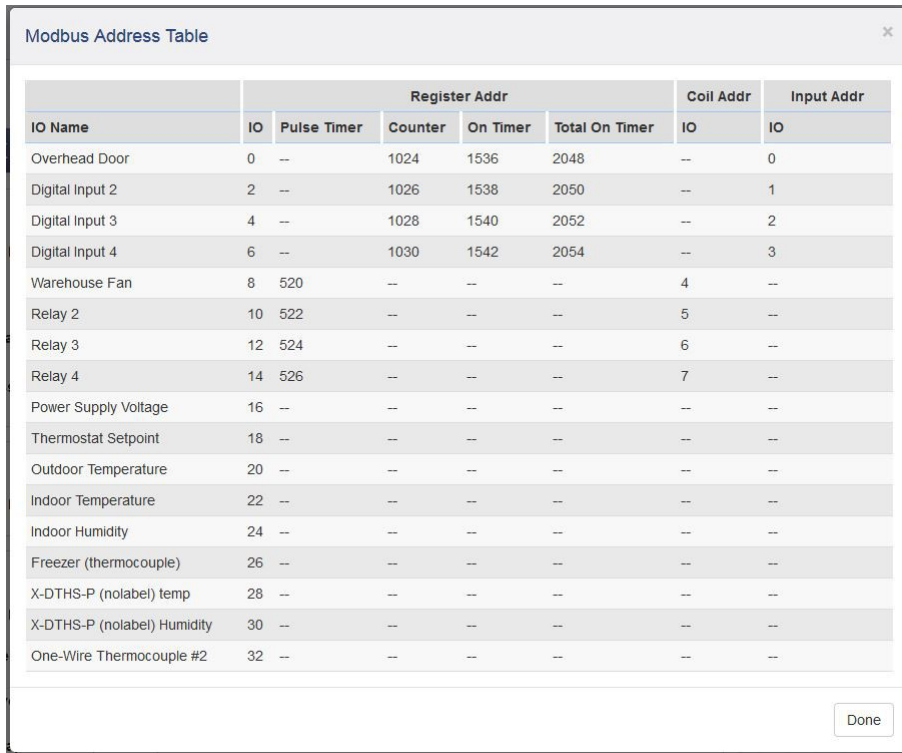

| IO Name | Register Addr | | | | | Coil Addr | Input Addr |
|-----------------------------|---------------|-------------|---------|----------|----------------|-----------|------------|
| | IO | Pulse Timer | Counter | On Timer | Total On Timer | | |
| Overhead Door | 0 | -- | 1024 | 1536 | 2048 | -- | 0 |
| Digital Input 2 | 2 | -- | 1026 | 1538 | 2050 | -- | 1 |
| Digital Input 3 | 4 | -- | 1028 | 1540 | 2052 | -- | 2 |
| Digital Input 4 | 6 | -- | 1030 | 1542 | 2054 | -- | 3 |
| Warehouse Fan | 8 | 520 | -- | -- | -- | 4 | -- |
| Relay 2 | 10 | 522 | -- | -- | -- | 5 | -- |
| Relay 3 | 12 | 524 | -- | -- | -- | 6 | -- |
| Relay 4 | 14 | 526 | -- | -- | -- | 7 | -- |
| Power Supply Voltage | 16 | -- | -- | -- | -- | -- | -- |
| Thermostat Setpoint | 18 | -- | -- | -- | -- | -- | -- |
| Outdoor Temperature | 20 | -- | -- | -- | -- | -- | -- |
| Indoor Temperature | 22 | -- | -- | -- | -- | -- | -- |
| Indoor Humidity | 24 | -- | -- | -- | -- | -- | -- |
| Freezer (thermocouple) | 26 | -- | -- | -- | -- | -- | -- |
| X-DTHS-P (nolabel) temp | 28 | -- | -- | -- | -- | -- | -- |
| X-DTHS-P (nolabel) Humidity | 30 | -- | -- | -- | -- | -- | -- |
| One-Wire Thermocouple #2 | 32 | -- | -- | -- | -- | -- | -- |

For example, to pulse Relay 3, write a 32-bit floating-point value in the endianness defined starting at register 524 and ending at register 525. Most Modbus programs do this by setting the start address to 524 and writing a quantity of two registers.

Remote Services

Remote Services allows internet access to an X-410 which is installed behind a network router, without the need to setup port forwarding in the router. It also allows for a streamlined installation without the need to directly access the device and configure it's network settings.

Remote Services can be enabled or disabled. If **Yes** is selected, Remote Services will be enabled as soon as the Submit button is pressed and the X-410 will immediately attempt to make a connection with the remote server (power-cycle not required). Once a connection is established, the connection will remain until it is disconnected by the remote server. By default, Remote Services is configured to connect to the ControlByWeb.cloud service. The default setting for this field is *No*.

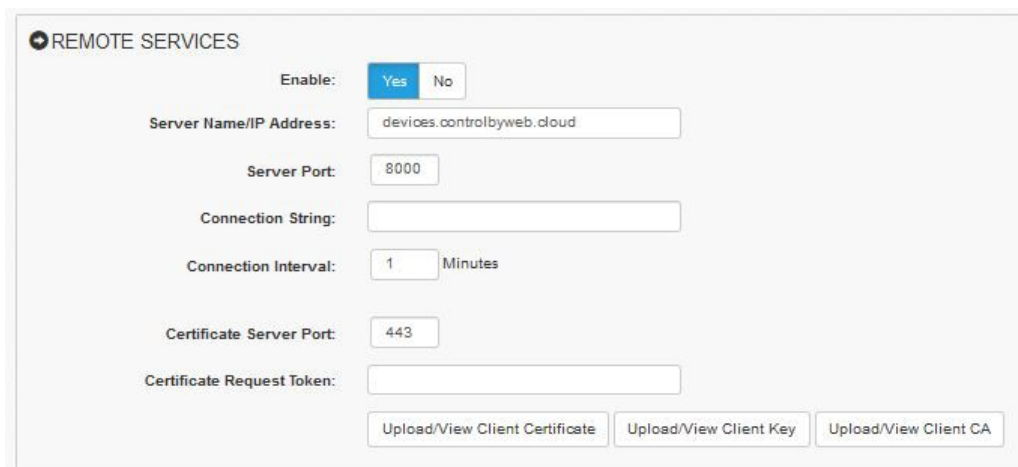

The screenshot shows a configuration panel titled "REMOTE SERVICES". It includes several fields and buttons:

- Enable:** A toggle switch set to "Yes".
- Server Name/IP Address:** A text input field containing "devices.controlbyweb.cloud".
- Server Port:** A text input field containing "8000".
- Connection String:** An empty text input field.
- Connection Interval:** A text input field containing "1" followed by "Minutes".
- Certificate Server Port:** A text input field containing "443".
- Certificate Request Token:** An empty text input field.
- Three buttons at the bottom: "Upload/View Client Certificate", "Upload/View Client Key", and "Upload/View Client CA".

Server Name/IP Address

Specify the name or IP address of the Remote Services server here. If the IP address is specified, enter it in this format `aaa.bbb.ccc.ddd`. For numbers that are less than 100, preceding zeros should not be included (for example, enter 80 rather than 080). This field can be up to 40 characters long, the default setting is: *devices.controlbyweb.cloud*

Server Port

Enter the TCP port used for the Remote Services server. This can be set within the range of 1-65535. The default setting for this field is 8000.

Connection String

This text is sent to the Remote Services server when the connection is established. This string should include any information required by the server for connection. For example, it may include an ID number, customer number, password, etc. The format is entirely dependent upon the server requirements. This field can be up to 80 characters long. By default this field is left blank, as the ControlByWeb cloud service does not use it.

Connection Interval

This field specifies the periodic interval in which X-410 attempts to connect to the remote server, or if X-410 is already connected, it is the interval in which X-410 sends the connection string followed by the current state of the device. This field can be set within the range of 1 to 60 minutes. The default setting for this field is 1 minute.

Certificate Server Port

The certificate server is a server that has been configured to deliver the Client Certificate, Key, and CA when requested by the X-410. These certificates and key are required for the X-410 to connect

to the remote service.

Certificate Request Token

When the X-410 has a valid Certificate Request Token entered, it will automatically attempt to request and download its Client Certificate, Key, and CA. Once successful, the token will be erased and the X-410 will stop its requests. (See *Remote Services* at the end of this section for more information.) It will then be able to authenticate and connect to the cloud service securely.

Upload/View Client Certificate

Uploads a client certificate that will be used for authenticating the X-410 to the cloud service.

Upload/View Client Key

Uploads a client key that will be used for encrypting the X-410 communications with the cloud service.

Upload/View Client CA

Uploads a CA that has been used to generate the client certificate and key. The X-410 will use this certificate to verify that the server it has connected to is the server that it expects to connect to.

Remote Services Notes: Remote Services initiates an outgoing connection to a server at a remote location. This can be used in an environment where a web server on the Internet provides a custom web page to X-410 and other ControlByWeb products. Users access the X-410 through the remote services web server rather than communicating directly with it. This method is sometimes referred to as “web services” and allows programmers to create powerful, custom web pages to multiple devices using the web programming languages of their choice.

The X-410 initiates the connection to the external web server (rather than the web server initiating communications to X-410). This has two main benefits. First, the web server does not need to know the IP address of X-410. This means that X-410 can get its IP address dynamically from a DHCP server, simplifying the installation. Second, since the connection from X-410 is outgoing, rather than incoming, the local router on the network where X-410 resides does not need to be configured to forward ports. This simplifies the installation. Since the router configuration is not modified, the risk of compromising security on the local network is eliminated. For more information about the Remote Services see *Section Using an External Web Server*.

SNMP AGENT

The X-410 Supports SNMP V1, V2c & V3. The SNMP agent is the server running on the X-410 responsible for receiving SNMP requests and returning SNMP responses. SNMP Managers are remote servers that the X-410 can send SNMP Trap and Notification messages to. The Agent is always enabled when SNMP is enabled. The SNMP Managers can be enabled/disabled separately. When using SNMP V3, the X-410 supports the User-based Security Model (USM).

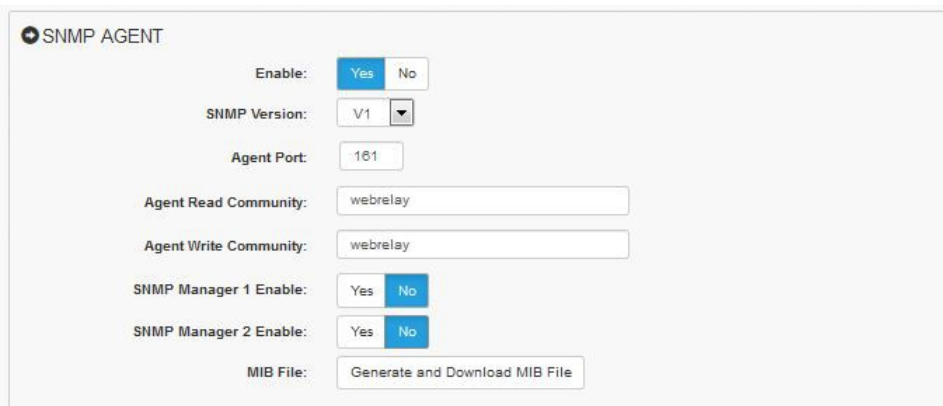

The screenshot shows the 'SNMP AGENT' configuration page. It features several settings: 'Enable' is set to 'Yes'; 'SNMP Version' is set to 'V1'; 'Agent Port' is set to '161'; 'Agent Read Community' and 'Agent Write Community' are both set to 'webrelay'; 'SNMP Manager 1 Enable' and 'SNMP Manager 2 Enable' are both set to 'No'; and the 'MIB File' section has a button labeled 'Generate and Download MIB File'.

SNMP Enabled

SNMP (Simple Network Management Protocol) can be enabled or disabled. The default setting for this option is *No*. (See *SNMP* at the end of this section for more information.)

SNMP Version

The X-410 supports versions 1, 2c, and 3. This option allows choosing what version of SNMP will be used, and will determine what SNMP options are presented. The X-410 will only respond to SNMP requests that use the selected SNMP version.

Agent Settings:

Agent Port

When SNMP is used, this field is used to specify the SNMP port that X-410 SNMP Agent listens on. The default setting for this field is 161.

Agent Read Community

The read community string is used for SNMP V1 and V2c requests. It is required to read I/O on the device using SNMP V1 or V2c.

Agent Write Community

The write community string is used for SNMP V1 and V2c requests. It is required to write I/O on the device using SNMP V1 or V2c.

Notification Retries

When sending Notifications, this field defines how many attempts the X-410 will make to send the notification to the SNMP Managers. Notification differ from Traps in that a response is expected back from the SNMP Manager.

Notification Timeout

When sending Notifications, this field defines how many seconds the X-410 waits for a response to a previously sent notification before attempting to send the Notification again.

Manager Settings:***Manager Enable***

A SNMP Manager is the server intended to receive traps and notifications from the X-410. The X-410 supports sending traps and notifications to two different SNMP managers. The default setting is *No*.

Manager Hostname/IP

This field is used to specify the hostname or IP address of the SNMP manager. The default setting for this field is 192.168.1.15.

Manager Port

This field is used to specify the SNMP Trap or notification port of the SNMP manager. The default setting for this field is 162.

Manager 1 Community

This field is used to defined the Trap/Notification community string used by the SNMP Manager for SNMP V1 and V2c. The SNMP manager will not accept the Trap/Notification without a correct community string.

The X-410 MIB File:***MIB File***

This button generates the Management Information Base (MIB) used for managing the entities in a communication network associated with the SNMP protocol. The file will be automatically generated and downloaded.

SNMP V3 Security Settings:

The Following settings appear when the SNMP version is set to Version 3. These settings configure the authentication and privacy protocols used by SNMP V3 User-based Security Model (USM). The Agent, and Both SNMP Managers each have their own set of USM settings. When SNMP V3 is selected, the community string settings disappear and are not used. They are replaced by the following settings.

Username

This field is defines the security username.

Auth Protocol

This field defines the authentication protocol used: None, MD5, SHA, SHA224, SHA256.

Auth Password

This field defines the authentication password.

Priv Protocol

This field defines the privacy protocol used: None, DES, AES128, AES192, AES256.

Priv Password

This field defines the privacy password used.

SNMP Notes: Simple Network Management Protocol (SNMP) is used to manage and administer network devices. X-410 supports SNMP V1, V2c, and V3 and can be configured here. Using SNMP, the I/O states of X-410 can be read as well as some basic information about the device. See *Section SNMP*

Requests, Objects and Community Strings for information about how to request information from X-410 using an SNMP manager.

IP Filtering

IP filtering can be enabled or disabled. IP filtering is used to restrict incoming network connections to only specific IP addresses. If a connection comes in to the X-410 that is not in the range of allowable IP addresses, the connection is terminated. The IP filter only applies to incoming connections and not to outbound connections such as those to DNS servers. The X-410 allows for two different ranges to be defined. If one of the ranges is not needed, the IP address in each of the three fields for a given filter must be 0.0.0.0. IP filter settings only take effect after the X-410 is power-cycled.

The screenshot shows a web-based configuration interface for IP filtering. At the top, there is a section titled "IP FILTERING" with a dropdown arrow. Below this, there is an "Enable:" section with two radio buttons: "Yes" (selected) and "No". Underneath, there are two filter configurations. "Filter 1" has a "Subnet Mask" of 255.255.255.0 and a "Range" from 192.168.1.1 to 192.168.1.254. "Filter 2" has a "Subnet Mask" of 0.0.0.0 and a "Range" from 0.0.0.0 to 0.0.0.0. At the bottom right, there are "Submit" and "Reset" buttons.

Filter Subnet Mask

This is the subnet mask that is applied first. If the IP address does not fit within this subnet, the connection will be terminated. This subnet mask is applied to the Filter 1 Range's first IP address (the start address).

Filter Range

The range of IP addresses within the defined subnet mask that are allowed to communicate with the X-410. The first field is the start address, the second field is the end address.

3.2.4 General Settings Tab > EMAIL SETTINGS

The Email parameters are set on this page.

The screenshot shows the 'EMAIL SETTINGS' configuration page. At the top, there is a 'GENERAL SETTINGS' header with a wrench icon, and a sub-header 'EMAIL SETTINGS' with an envelope icon. The form contains the following fields and controls:

- SMTP Server:** A text input field.
- Connection Security:** A dropdown menu currently set to 'None'.
- Server Port:** A text input field containing the value '25'.
- Username (If required):** A text input field.
- Password (If required):** A text input field with a 'Hide / Show Password' checkbox below it.
- Return Email:** A text input field.
- Email 1:** A text input field.
- Email 2:** A text input field.
- Email 3:** A text input field.
- Email 4:** A text input field.
- Email 5:** A text input field.
- Email 6:** A text input field.
- Email 7:** A text input field.
- Email 8:** A text input field.
- Email Message:** Two radio buttons labeled 'Full' and 'Short', with 'Full' selected.
- Send Test Email:** A button.
- Submit:** A blue button.
- Reset:** A button.

SMTP Server

The name of the SMTP (Simple Mail Transfer Protocol) mail server (i.e., mail.example.com) or the IP address of the mail server (i.e., 192.10.10.10) should be entered in this field. There is no default setting for this field.

Note: If the server name is entered and not the IP address, the address of a DNS server will be required in the DNS field.

Connection Security

Select the security method used for sending the email. There are two methods used to securely transmit email messages. STARTTLS and TLS/SSL. When STARTTLS is chosen, the X-410 initially makes an unsecured connection to the SMTP server and then negotiates a TLS encrypted connection. When TLS/SSL is chosen, the connection to the server will be securely negotiated with the SMTP server from the beginning. Both methods are secure. STARTTLS generally requires the use of port 587 and TLS/SSL generally requires the use of port 465. No security method (*none*) is also an option, and still supported by some SMTP servers. This method generally uses port 25.

Email Server Port

This field is used to specify the SMTP Mail Server Port. The default setting is 25, which is the standard SMTP port. This port will generally be different if a connection security method is chosen.

User Name (If Required)

If the SMTP mail server requires authentication, the user name must be entered here. There is no default setting for this field.

Password (If Required)

If the SMTP mail server requires authentication, the password must be entered here. There is no default setting for this field.

Return Email

The X-410 will not receive email messages, but when the X-410 sends email messages, it must include a return email address. This field is used to specify the return email address. Note that although the X-410 will send email messages with any email address specified in this field, some email filters (spam filters) will not allow messages through that include an invalid email address. There is no default setting for this field.

Email 1 to Email 8

Enter the email addresses of up to eight recipients. Email messages will not be sent to all of these addresses, but only those selected when configuring email notifications. When creating Tasks, different recipients can be selected to receive different email notifications.

Email Message

Choose either "Full" or "Short" email formats. *Full* sends an email with all visible fields on the control page. *Short* sends an email only showing what triggered the email.

Send Test Email

This button sends a test email to the first email address in the email list using the currently configured network and email settings. After the settings are automatically submitted, a progress window will pop-up and display the result of the test email:

- Success
- Failed DNS Lookup
- No Response from DNS server. Check DNS addresses, Power Cycle Device, etc.
- Failed
- Bad Username/Password
- Missing recipient email address(es)
- Server Address/Hostname does not exist or is misspelled
- Server Address/Hostname is blank
- No Response from SMTP server. Check server address and security/port combination

Email Notification Description

The X-410 can be configured to send messages to up to eight email addresses when certain events occur. Events that can trigger email messages include relay/input state changes, Vin changes, temperature/humidity changes, and commands sent from a BASIC script.

When an email message is sent, it looks similar to this:

```
X-410

Trigger: Relay 1 ON

Relay 1: ON
Relay 2: OFF
Relay 3: OFF
Relay 4: OFF
Input 1: OFF
Input 2: OFF
Input 3: OFF
Input 4: OFF
Vin: 12.00 V
Sensor 1: 76.2° F
Sensor 2: 73.7° F
Sensor 3: 32.0° F
Sensor 4: 84.5° F
Count 1: 5.00
Count 2: 0.00
Time: 09/27/2017 15:30:00
```

Note: Relays, Inputs, Count, and Sensor names as well as ON and OFF status text may be customized by the installer in the setup pages. The same field names are used on the Control Page.

Subject Line

The top line (that reads “X-410”), appears in the subject line of the email message. This is the same text that appears as the header on the *Control Page*. It is configured in the *Main Header Text* field under the *Monitor & Control Tab > CONTROL PAGE SETUP* tab.

Trigger

The first line displayed in the body of the message shows the event that triggered the message. The text “Trigger” will always appear and cannot be changed. The remaining text includes the trigger name, and what caused the trigger. The text that describes the trigger and its current state are configured in the setup pages as described below.

Current Status of the Digital Inputs, Relays, Vin, and Sensors

The remainder of the email message will display the same information shown on the *Control Page*. Fields not displayed in the *Control Page* will not be included in the email message. Displayed fields may be configured in the *Monitor & Control Tab > CONTROL PAGE SETUP* page. Alternatively, the email message can be set from Full to Short on the *Email* tab of the setup pages. Setting the Email Message to Short will only include the trigger and the I/O that caused it to show in the email body.

3.2.5 General Settings Tab > **PASSWORDS**

The X-410 requires passwords to access specific resources. The passwords can be changed on this page. Passwords must be 8 to 18 characters, both alphabetic and numeric characters are recommended. A hide/show check-box selects if the password will be shown. When a password is changed, it must be entered twice for verification. If the password is not entered identically in both fields, the password will not be changed.

Administrator

Administrators have access to all setup, task and control pages. This access privilege is normally used by a system integrator or installer to setup the I/O, control logic and user interface. The *Administrator* username is `admin` (all lower case). The default password is `webrelay` (all lower case).

Manager

Managers have access to tasks and control pages. This access privilege can be used for example, to allow a door access schedule to be changed for a holiday. A *Manager* cannot change the network settings, I/O, or control logic. The *Manager* username is `manager` (all lower case). The default *Manager* password is `webrelay` (all lower case).

The password access for *Managers* can be enabled or disabled. When a manager logs into the setup pages, they will receive a subset of the menu options allowing them to edit Scheduled Tasks and view the control pages.

User

Users have access privilege to the control page only. This access privilege is for users and operators to monitor sensors or control outputs that are on the control page. The password access for *Users* can be enabled or disabled. When this field is set to `Yes`, a password will be required to view the *Control Page*. The default setting for this field is `No`. The *User's* username is `user` (all lower case). The default *User* password is `webrelay` (all lower case).

Note: Since Modbus has no provision for passing passwords, Modbus will be disabled if the Control Page password is enabled.

Device PSK

The Device PSK is a pre-shared key to used by other devices when communicating with this device securely. When adding a device as a remote device, that device's pre-shared key is asked for during the configuration. This is where that PSK is defined.

The PSK is a 32-byte hexadecimal key with valid characters being a-f and 0-9. Anything can be used as the devices PSK as long as it is 32 bytes long and contain only valid characters. The Generate PSK button can be used to request that the X-410 generate a secure, random PSK. This is the preferred way to generate the PSK. Once generated, a new PSK needs to be generated unless the old one has been compromised. A new PSK is generated when the device is reset to factory defaults.

3.2.6 General Settings Tab > DATE & TIME

The X-410 uses the time of day for scheduled events, such as turning the relays on or off at scheduled times and for logging (a time stamp is included with each logged event). The time is stored and displayed in 24-hour time format. The X-410 has a capacitor-backed, real-time-clock circuit that will sustain the time for several days in the event of a power failure.

Current

This is the current date and time maintained in the X-410. The time is stored and displayed in 24-hour format.

Set Time:

This drop-down list offers two options for setting the time: *Manually* or *Sync with NTP server*.

The options that follow this field will change based upon how this option is set:

| | |
|-----------------------------|--|
| Manually | Requires the user to enter the time and date. |
| Sync with NTP server | Allows the user to set the clock automatically by using an NTP (Network Time Protocol) server. |

Manual Time Configuration

Date

The current date is entered by selecting the month, day and year, using the drop-down boxes.

Time (24 Hour Format)

Enter the time as HH:MM:SS. (HH represents hours in 24-hour format [00-23], MM represents minutes [00-59], SS represents seconds [00-59].)

UTC Offset

Time servers return the current time in Universal Time (GMT). It is common for many servers and data loggers to use GMT as their official time, even when they are not located within the GMT time zone. The default value for this field is -7 (Mountain Standard Time). For convenience, the time can be converted to local standard time by entering the offset here. This manual cannot include the UTC Offset for all parts of the world, but the offset for GMT time and the four major US Time zones are listed here.

- GMT Time: 0
- Eastern Standard Time: -5:00
- Central Standard Time: -6:00
- Mountain Standard Time: -7:00
- Pacific Standard Time: -8:00

SYNC With NTP Server

NTP Host Name

This field is used to specify the name or IP address of the NTP server. If a name is specified, a working DNS server address must be entered into the Network settings. If the IP address is specified, it should be entered in the following format aaa.bbb.ccc.ddd where each of the letters represents a number between 0 and 255. This field can be up to 40 characters. There is no default value for this field.

Many NTP Internet servers are available. In addition, many desktop computers will function as an NTP server (both Mac and PC). If a desktop computer is used, firewall settings may need to be adjusted to allow for NTP communications on UDP port 123.

Public NTP servers can be found at www.pool.ntp.org. Some of these are listed below.

US Servers (<http://www.pool.ntp.org/zone/us>):

- 0.us.pool.ntp.org
- 1.us.pool.ntp.org
- 2.us.pool.ntp.org
- 3.us.pool.ntp.org

North America (<http://www.pool.ntp.org/zone/north-america>):

- 0.north-america.pool.ntp.org
- 1.north-america.pool.ntp.org
- 2.north-america.pool.ntp.org
- 3.north-america.pool.ntp.org

Europe (<http://www.pool.ntp.org/zone/europe>):

- 0.europe.pool.ntp.org

1.europe.pool.ntp.org
2.europe.pool.ntp.org
3.europe.pool.ntp.org

Australia (<http://www.pool.ntp.org/zone/au>):

0.au.pool.ntp.org
1.au.pool.ntp.org
2.au.pool.ntp.org
3.au.pool.ntp.org

South America (<http://www.pool.ntp.org/zone/south-america>):

0.south-america.pool.ntp.org
1.south-america.pool.ntp.org
2.south-america.pool.ntp.org
3.south-america.pool.ntp.org

Africa (<http://www.pool.ntp.org/zone/africa>):

1.africa.pool.ntp.org
1.pool.ntp.org
3.pool.ntp.org

NTP Sync Interval

This option allows the user to specify how often the time on the X-410 will be synchronized with the time server. When the Submit button on this page is pressed, the X-410 will immediately synchronize with the time server. If Daily, Weekly, or Monthly options are selected, X-410 will thereafter re-synchronize with the time server at the period interval specified starting at 12:00 AM (00:00).

To prevent multiple X-410s from overwhelming the NTP server at power on, the exact time the NTP Request occurs is 12:00 AM (00:00) plus the minute equivalent of the last two digits in the models serial number. For example, if the last two digits in the model's serial number were -09, the NTP Request will occur 9 minutes after 12:00 AM. The default value of this setting is Once (the unit will immediately sync with the NTP server, but will not automatically sync again).

Sync on Power Up

When this option is set to Yes, the X-410 will be synchronized with the time server each time it is powered.

Note: If the X-410 will lose power on a frequent basis, it may be beneficial to set this option to No. Some servers are configured to dis-allow access from client devices that excessively request their services. The default value of this setting is No.

Daylight Savings

Enable

Daylight Savings can be enabled or disabled. The default setting is Yes.

In many parts of the United States and in some other countries, the time is shifted forward by one hour during the summer months. This is an effort to conserve energy by making the daylight last longer into the evening hours. If this option is set to Yes, the time on the X-410 will automatically be shifted forward by one hour between the hours of 12:00 AM – 5:00 PM on the Daylight Savings Start date set below, and it will shift back to standard time between the hours of 12:00 AM – 5:00 PM on the Daylight Savings End date set below. The time change is made at a random time within the

previously mentioned, five-hour time frame, in order to prevent multiple devices from simultaneously requesting a time and overwhelming the NTP server.

Note: Enabling the daylight savings time adjustment, scheduled events will be adjusted for the new time. Logged data includes a time stamp based upon the current time in the device followed by DST when the device is in daylight savings and STD when it is not. To avoid confusion, many servers and data loggers are set to remain on GMT time and do not shift for daylight savings.

Daylight Savings Start Date

This is the date that daylight savings will start. Note that on this date, between the hours of 12:00 AM – 5:00 PM, the current time will be shifted forward by one hour (i.e. the time will jump from 12:02 AM [00:02] to 1:02 AM [01:02]). By default this is set to the 2nd Sunday in March which is the date used in the United States.

Daylight Savings End Date

This is the date that daylight savings will end. On this date, between the hours of 12:00 AM – 5:00 PM, the current time will be shifted backward by one hour (i.e. time will jump from 12:02 AM [00:02] to 11:02 PM [23:02] the day before). By default this is set to the 1st Sunday in November which is the date used in the U.S.

3.2.7 General Settings Tab > BACKUP/RESTORE

Use these tools to backup the settings (excluding scripts and SSL Certificates) on this device, or to copy settings from one device to another. This is useful for “cloning” or copying devices, or to maintain a backup copy of the settings.

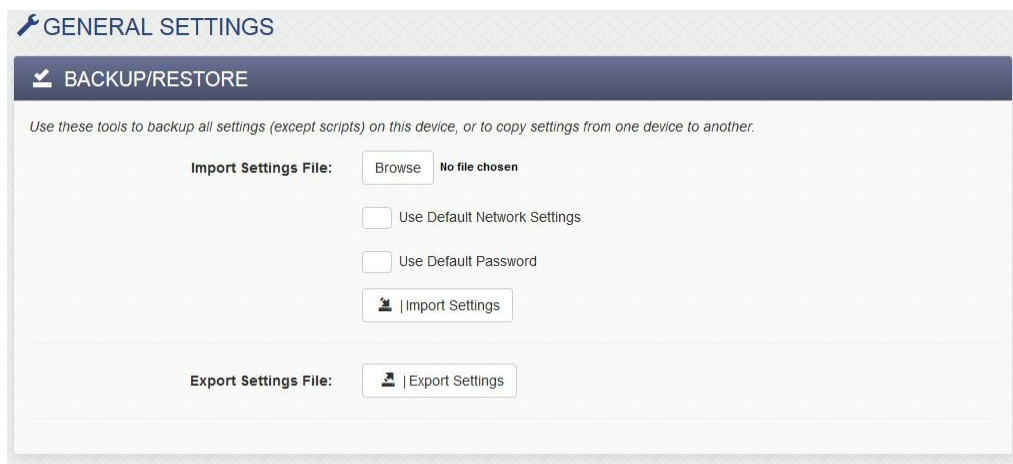

Import Settings File

To import settings from an external file, first click the *Browse* button and select the desired *settings.txt* file on your computer. If *Use Default Network Settings* is checked, any network settings in the file are ignored and the network settings are forced to the default state. If *Use Default Password* is checked, the Administrator password in the file is ignored and the Administrator password is forced to the default state. Click the *Import Settings* button to import (load) the settings from the selected file.

Export Settings File

Click the *Export Settings* button to export all of the current settings to a “settings.txt” file. If desired, the file can be opened and examined with a text editor. Note that BASIC scripts and SSL Certificates are not included in this settings file and should be saved separately.

3.3 Remote Devices Tab

The X-410 can monitor and control up to 100 I/O points on up to 32 other ControlByWeb devices. This feature can be used to implement a distributed control system. With distributed control, intelligent control devices such as the X-410 are placed in close proximity to the sensors, relays, motors and valves that are to be monitored and controlled. The control devices are connected together into a control system with Ethernet communication. No central control cabinet is needed with long wire runs to the sensors, relays, motors and valves in your facility. With Ethernet communication the control system can accommodate applications with long distances between the devices being monitored and controlled. Each device on the bus implements a portion of the control application.

To access I/O on remote devices, first add the remote device to this device list, then add and configure the I/O under the *I/O Setup* tab. Remote devices appear in the table on the remote devices tab and can be created, edited or deleted as needed.

REMOTE DEVICES

REMOTE DEVICE LIST

This module can monitor and control I/O from other ControlByWeb devices. To access I/O on remote devices, first add the device to this list, then add and configure the I/O under the I/O Setup tab.

| Name | Address | Model # | Serial # | Mode | Status | Edit |
|----------|------------------|---------|---------------|------------------------|--------|--------|
| Device 1 | 192.168.1.3:80 | X-410 | 000CC8030303 | Standard (Poll Device) | 3ms | Edit X |
| Device 2 | 192.168.1.180:80 | X-410 | 000CC803E14D | Standard (Poll Device) | 3ms | Edit X |
| Device 3 | 192.168.1.188:80 | X-410 | 000CC801A001 | Standard (Poll Device) | 3ms | Edit X |
| Device 4 | 192.168.1.163:80 | X-410 | 000CC8FFEEEDD | Standard (Poll Device) | 3ms | Edit X |

Find Devices Add Remote Device +

To add a remote device, click *Add Remote Device*. Depending on the *Model* selected in the pull down ▼ list, the available settings will change to accommodate the capability's of the remote device. For example, only certain devices can support encrypted communications.

Device Name

This text field allows setting a descriptive device name that will be referenced throughout the setup pages. Up to 24 characters may be entered in this field. The default text is “Device 1”. Set the name to a descriptive value such as “Warehouse Lights”.

Model

Click the ▼ symbol and choose from the list of supported remote devices. When changing the device type of a previously configured device, only I/O compatible device types will be enabled.

Serial Number

The MAC address of the remote device is entered here. The serial number is only required for 400 series devices. The default value is 000CC8000000

IP Address/Hostname

The IP address or hostname of the remote device. Up to 61 characters may be entered in this field.

Port

The TCP port number of the remote device. This must match the TCP port (HTTP port) set in the remote device. The valid range is 1 to 65535. The default port number is 80. If *TLS PSK Encryption* is selected (see below), the default port number is 443.

Security Configuration

Select either *Unencrypted* or *TLS PSK Encryption*. When both devices are on the same local network unencrypted communication is usually acceptable. When devices communicate across the Internet, encrypted communication is recommended. Performance with encrypted communication will be slightly slower.

Device Control Password

This setting is shown if the security configuration is set to *Unencrypted*. Enter the password required to access the I/O on the remote device. This password will be the same as the ‘User’ password on the remote device.

Device PSK

This setting is shown if the security configuration is set to *TLS PSK Encryption*. This is the pre-shared key required to access the I/O on the remote device using encryption. The pre-shared key can be found on the Passwords tab on the remote device.

Device Admin Password

Enter the admin password to be used to access the remote device I/O setup page. This setting is only shown if the remote device supports this feature. This feature will only work if the remote device is connected to the Ethernet and both the Serial Number and IP address are set (above). The X-410 will automatically add itself to the remote device’s device list.

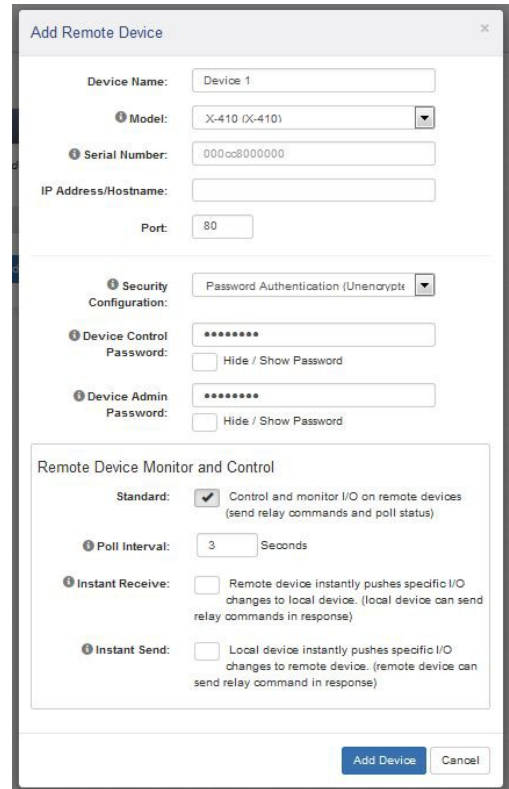

Remote Device Monitor and Control:

X-400 series devices can be remotely controlled with *Instant Send* or *Instant Receive* communication architectures. If the remote device selected from the pull down list does not support *Instant Send* or *Instant Receive*, these settings will not be shown and only the polling interval can be configured.

Standard

If the check-box is enabled, the remote device is controlled and monitored by sending relay commands when needed and periodically polling its status.

Poll Interval

If polled communication is selected (see above), the local (this) device will request the state of the remote device at this polling interval.

Instant Receive

If the check-box is enabled, the remote device instantly pushes specific I/O changes to the local (this) device. The local device can send relay commands in the response. The remote device will push I/O state to the local device periodically and/or when triggers are set up on the remote device to do this.

Instant Send

If the check-box enabled, the local (this) device instantly pushes specific I/O changes to the remote device. The remote device can send relay commands in response. The local device will push the state of all local I/O to the remote device periodically and/or when triggers are set up with an Action (see Control/Logic Tab > TASK/FUNCTIONS).

Poll Interval

If *Instant Send* is selected (see above), the local (this) device will request the state of the remote device at this polling interval.

Notes for Remote Devices

Communication with remote ControlByweb™ devices is done using both event driven and polled communication models. Relay and output I/O changes sent to the remote device are event driven. Digital inputs and input I/O of the remote device are sampled at a periodic rate set by the polling interval. The latency of the system is determined by the polling interval. ControlByWeb X-400 series devices however, allow event driven communication in both directions where I/O changes are “pushed” to other devices. This has the advantage of avoiding the latencies of the polling interval, and since the information is “pushed”, the communication can occur through a router or firewall without the need to configure port forwarding.

Communication with non X-400 series devices is done with *Polled* communications only.

Polled

The state of the remote device is periodically polled by requesting state.xml. The remote device responds with its current state.xml. Changing remote relays is event driven (immediate.) Choose this setting for non ControlByWeb 400-series devices and for monitoring the outputs of the remote device where the state is slowly changing (temperature, humidity etc.)

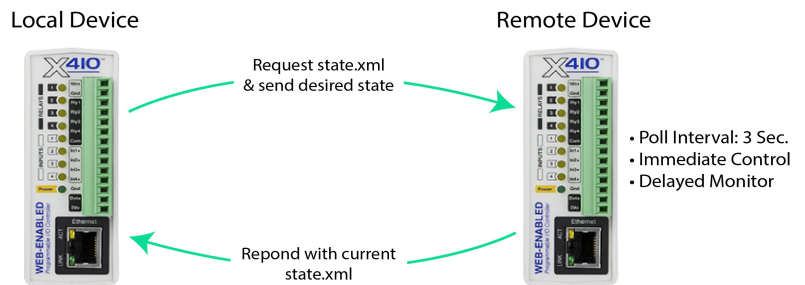

Communication with ControlByWeb X-400 series devices can be done with the *Publisher/Subscriber* communication model as well.

Publisher

The remote device is event driven and pushes (publishes) its state changes to the local device. The local device can send control messages in the response. The update of remote relay states is delayed. Choose this setting for applications where the local device must immediately know the I/O state changes of the remote device.

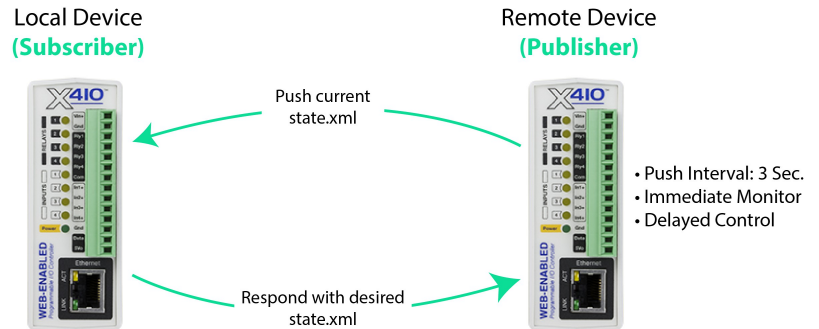

Subscriber

The local device is event driven and pushes (publishes) its state changes to the remote device. The remote device can send relay commands in response. Choose this setting for applications where the remote device must immediately know the state of changes to the local device inputs.

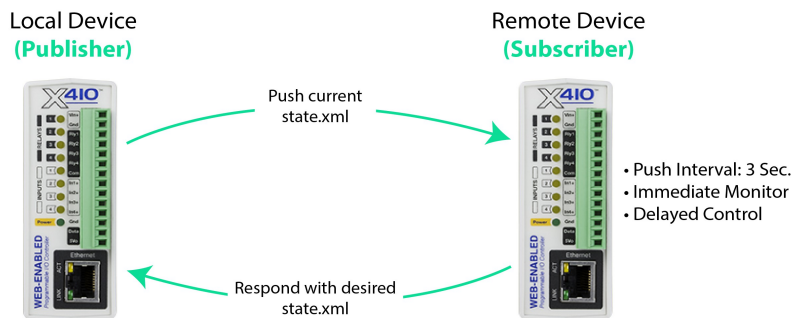

3.4 I/O Setup Tab

The X-410 supports a total of up to 100 Input/Output (I/O) resources. These can be a mix of relays, digital inputs, 1-Wire sensors, registers, counters, timers and Vin. These can also include I/O found on up to 32 remote devices. Fixed I/O such as the relays and digital inputs of the X-410 are automatically predefined in the I/O resource list.

As I/O resources are added, they appear in rows in the respective setup sections and can be created, edited or deleted as needed. If an I/O resource is deleted, any dependent *Scheduled Task*, *Conditional Task*, *Reboot Task* or Control Page widget which reference the I/O resource being deleted is automatically deleted. If logging is enabled for the I/O resource being deleted, the I/O resource is automatically removed from the logging list and the log file is reset (a warning is given that the log file will be deleted.) The log file is deleted since the log file format is dependent on the I/O being logged. If a remote device is deleted, any dependent I/O resources, control tasks, Control Page widgets and logging are also automatically deleted.

3.4.1 I/O Setup Tab > RELAYS

This page allows configuration of both local and remote relays if remote device have been configured. There are two tables, one for local relays and one for remote.

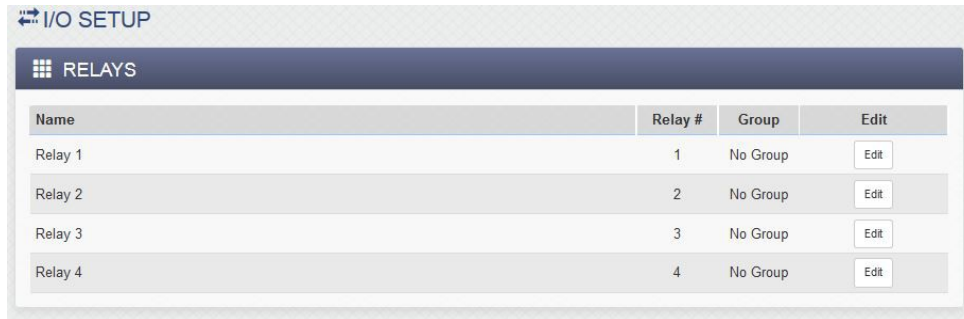

| Name | Relay # | Group | Edit |
|---------|---------|----------|------|
| Relay 1 | 1 | No Group | Edit |
| Relay 2 | 2 | No Group | Edit |
| Relay 3 | 3 | No Group | Edit |
| Relay 4 | 4 | No Group | Edit |

Click the respective *Edit* button to configure each relay. Local relays have some settings that remote relays don't have and vice versa.

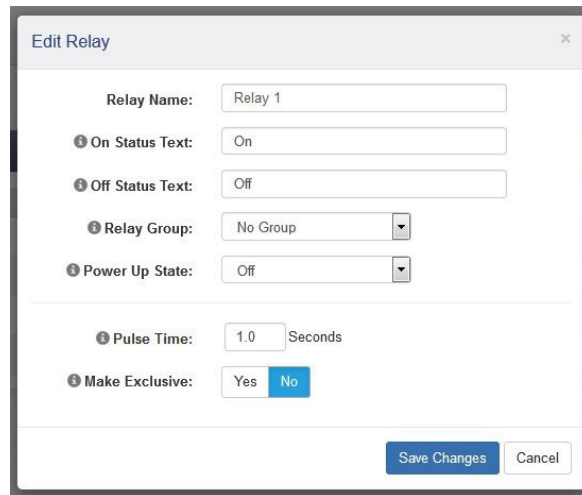

Edit Relay

Relay Name:

On Status Text:

Off Status Text:

Relay Group:

Power Up State:

Pulse Time: Seconds

Make Exclusive:

Relay Options

Relay Name

This text field describes the function of the selected relay. The label text appears to the left of the corresponding relay status on the *Control Page* and in the email message when email alerts are enabled. When later defining the control logic, logging and other settings, this label appears in the pull-down lists of relay resources. Up to 27 characters may be entered in this field. The default text is "Relay #". Set the name to a descriptive value such as "Warehouse Fan".

On Status Text

The text in this field specifies the text that will be displayed in the *Control Page* and in email messages when the relay is On. Up to 16 characters may be entered in this field. The default text is "On". Set the status text to a descriptive value such as "Fan On".

Off Status Text

The text in this field specifies the text that will be displayed in the *Control Page* and in email messages when the relay is Off. Up to 16 characters may be entered in this field. The default text is "Off". Set the status text to a descriptive value such as "Fan Off".

Local Relay Options

Relay Group

The X-410 can group some or all of the relays into "groups". Combining relays into groups provides a simple method of controlling multiple relays at once. For example, a conditional task can have an action to turn on relay group 1 that would cause all the relays assigned to relay group 1 to turn on at the same time when triggered. Each relay can still be controlled independently while assigned to a relay group. In applications where a large number of relays are used, this scheme allows one task to control all of the relays with one Action.

Power Up State:

This drop-down menu specifies the state of the relay when the X-410 is powered up:

| | |
|------------------------|--|
| Off | The relay will be off upon power up. This is the default setting. |
| On | The relay will be on when power is applied to the X-410. |
| Last State | Upon power up, the relay will return to its last state when the X-410 was powered off. |
| Scheduled State | When the device is powered up, its state will be determined by any scheduled tasks configured to change the relay state. For example, if a scheduled task turns the relay on at Noon and another scheduled task turns the relay off at 1:00 p.m everyday, then if the device loses power and comes back on between Noon and 4:00 p.m., the relay will be on. If it comes back on any other time, it will be off. |

Pulse Time

When the X-410 receives a pulse command for the relay (through the web page or through a command), the relay will pulse for the time specified in this field. Note that when a pulse command is sent through the command interface, the command can include a pulse time which will override this value (for that pulse only). The time is specified in seconds and can range from 0.1 seconds to 86400 seconds in 0.1 second increments. The default time is 1.0 seconds.

Note that if additional pulse commands are issued to the relay before the pulse time has expired, the

relay will remain “on” and the pulse timer will be set to the full pulse time once again, extending the total “on” time.

Make Exclusive

If set to *Yes*, whenever this relay is turned on, all other local relays will be forced off. Making a relay exclusive can work as a fail-safe if there are two relays that should never be enabled at the same time. This feature is used, for example, to prevent the left/right motor controls of a pan-tilt camera from being activated at the same time. Or similarly, to prevent more than one relay of the open/close/stop controls of an overhead door from being activated at the same time.

Remote Relay Options

Device

For remote relays, this settings specifies the device that the remote relay is found on.

Device’s Relay #

For remote relays, this settings specifies the relay number on the remote device.

3.4.2 I/O Setup Tab > DIGITAL INPUTS

This page has settings for each of the X-410's four local digital inputs as well as any remote digital inputs that have been added. The digital input resources can be named and have binary (true/false) values. Digital inputs appear in tables on the digital inputs tab and can be created, edited or deleted as needed.

Each of the digital inputs can be configured for use with a 24-bit digital counter which counts the number of pulses on the respective digital input. The counters can count up to 200Hz and can be used with paddle wheel flow-meters, traffic sensors and other sensors which output pulses. The counters can be named and work similar to *Registers* where the counter value is accessible to Conditional Tasks, BASIC scripts and control page widgets. The counters associated with digital inputs 1 and 2 are stored in battery-backed memory and will retain their count through a power loss; however, the counters will not continue to increment while the X-410 power is off.

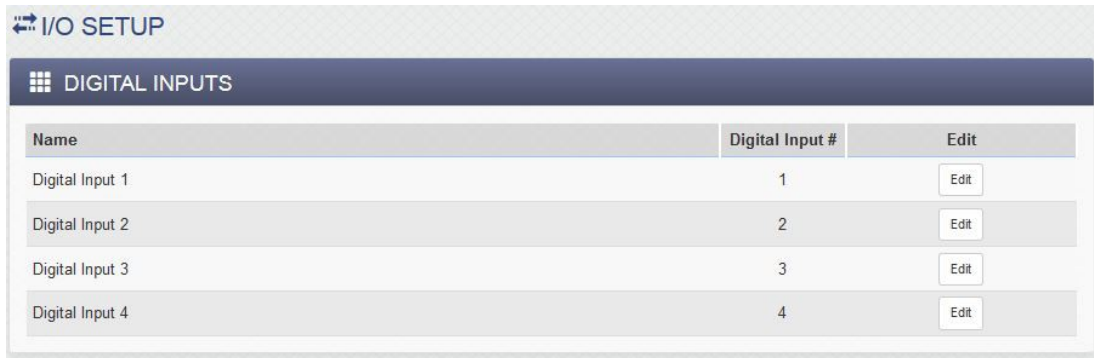

Click the respective *Edit* button to configure each digital input.

Digital Input Options

Digital Input Name

This text field describes the function of the selected digital input. The label text appears to the left of the corresponding digital input status on the *Control Page* and in the email message when email alerts are enabled. When later defining the control logic, logging and other settings, this label appears in the digital input pull-down list. Up to 27 characters may be entered in this field. The default text is "Digital Input #". Set the name to a descriptive value such as "Warehouse Door".

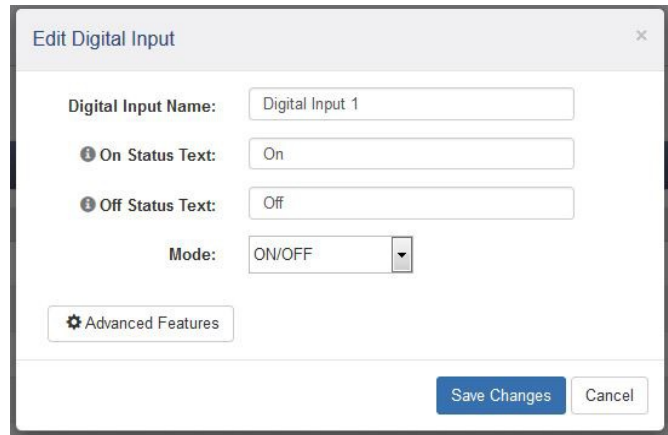

On Status Text

The text in this field specifies the text that will be displayed in the *Control Page* and in email messages when the digital input is On. The digital input is considered "on" when sufficient voltage is applied to the input. Up to 16 characters may be entered in this field. The default text is "On". Set the status text to a descriptive value such as "Door Open".

Off Status Text

The text in this field specifies the text that will be displayed in the *Control Page* and in email messages when the digital input is Off. Up to 16 characters may be entered in this field. The default

text is “Off”. Set the status text to a descriptive value such as “Door Closed”.

Mode:

The digital input can be configured for several operating modes:

| | |
|------------------|---|
| On/Off | A single I/O resource with the name “name” is created, where name is the digital input name defined above. The resource has binary (true/false) values. |
| Counter | The digital input is configured as a digital counter which counts the number of pulses on the respective digital input. Two I/O resources are created: name and name.counter. The counter value can be scaled into engineering units and is accessible to conditional tasks, BASIC scripts, Modbus and control page widgets. The counters associated with digital inputs 1 and 2 are stored in battery-backed memory and will retain their count through a power loss; however, the counters will not continue to increment while the X-410's power is off. |
| Frequency | The frequency of the respective digital input is measured by counting the number of pulses that occur during a period of one second. The value is updated once each second. A single I/O resource is created in the form name.frequency. The frequency value can be scaled into engineering units and is accessible to Conditional Tasks, BASIC scripts, Modbus and Control Page widgets. |

Units

Text entered here will be displayed on the right of the value when shown on the Control Page. This text does not affect the underlying value. Set the units to GPM, ea., mph etc.

Decimal Places

The number of digits displayed to the right of the decimal point. This does not affect the accuracy of the underlying value.

Slope (Multiplier)

The counter and frequency values can be scaled into engineering units. The X-410 reads the raw value from the counter and calculates a new value in engineering units. This scaled value is calculated using the following $y=mX+b$ formula..

$$\text{Scaled Value} = \text{Slope} * \text{Count} + \text{Offset}$$

The calculated scaled value is used for logs, email messages, control pages, XML pages, and is returned when Modbus values are read.

The “slope” in the formula above is provided by the user and is entered in this field. When both the slope and offset are set to their default values ($m=1$ and $y=0$) the scaled value equals the actual count.

Offset

The “offset” in the formula above is provided by the user and is entered in this field. The default value for this field is 0.

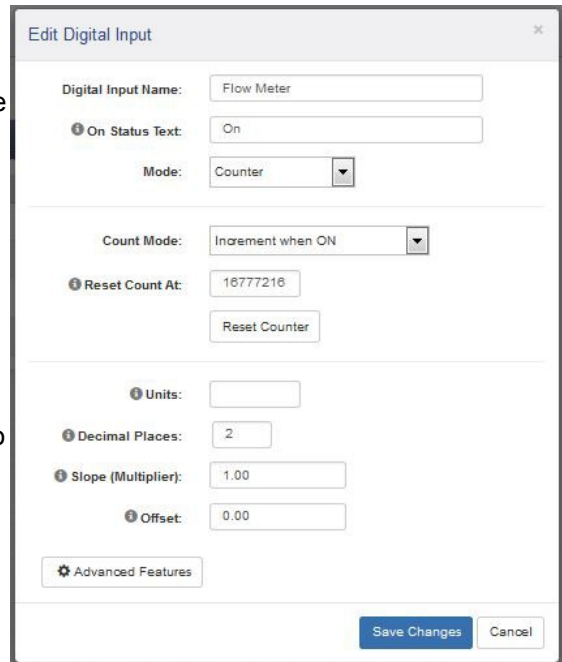

Counter Options

Digital Input Count Mode

| | |
|-------------------------------------|---|
| Increment when ON | Count on the rising edge of the pulse |
| Increment when OFF | Count on the falling edge of the pulse |
| Increment when input changes | Count on both rising and falling edges of the pulse |

Reset Count At

The counters automatically “roll over” to zero when the count reaches the value of this setting (modulo n). This setting is an integer for the raw count, before any slope multiplier or offset is applied. When *name.counter* is accessed by Conditional Tasks, BASIC scripts and Control Page widgets, the slope multiplier and offset are applied, and the value is a single precision floating point value.

Reset Counter

This button manually resets the counter to zero

Advanced Features

The digital inputs can be configured for several additional operating modes:

Hold Time (de-bounce): The input must remain *On* for this amount of time before the logic considers this input to be *On*. For switches and other noisy sensors, this eliminates problems with falsely detecting multiple *On* states before the input becomes stable. The default setting is 20ms and can be set from 0-250ms. The digital input is processed by this setting before it is applied to the on/off, counter and frequency logic. This setting directly limits the maximum input frequency that can be measured.

Measure On-Time: When this feature is enabled, the time that the input is on is measured. This value will be cleared when the input changes from “off” to “on”. When the input changes from “on” to “off” the value will be frozen and can be accessed as long as the input remains “off”. The *On-Time* only starts counting once the debounce time has expired and continues after the input goes off until the debounce timer expires again. An I/O resource is created in the form: *name.onTime*

Measure Total On-Time: When this feature is selected, the accumulated time that the input is on is measured. When the input is off, the timer stops. When the input goes on again, the timer resumes. This feature is useful for example, to measure the total run time of a machine to determine when maintenance is needed. The *Total On-Time* only starts counting once the debounce time has expired and continues after the input goes off until the debounce timer expires again. An I/O resource is created in the form: *name.totalOnTime*

Remote Digital Input Options

Device

For remote digital inputs, this settings specifies the device that the remote digital input is found on.

Device's Relay

For remote digital inputs, this settings specifies the digital input number on the remote device.

Note: For remote counters, frequency, etc., the values are read from the remote device and not calculated locally.

3.4.3 I/O Setup Tab > 1-Wire SENSORS

This tab is used to configure local and remote temperature, humidity, and/or other 1-Wire sensors. Up to 16 1-Wire sensors can be connected to the X-410. The X-410 will automatically detect the type of sensor connected. Once added to the X-410, 1-Wire sensors appear in the table on the 1-Wire Sensors tab and can be created, edited or deleted as needed.

Every 1-Wire sensor comes from the factory with a unique, non-changeable address. Once the sensor is connected to the X-410, the X-410 must associate a sensor name with the sensor address. You must define a sensor name and associate an address for each 1-Wire sensor. For remote 1-Wire sensors, only the device and sensor number (not address) are needed (the 1-Wire address should be configured locally on the remote device).

For example, a list of named, associated 1-Wire sensors is shown:



To add a new local 1-Wire sensor, click *Add 1-Wire Sensor* in the local 1-Wire Sensors table.

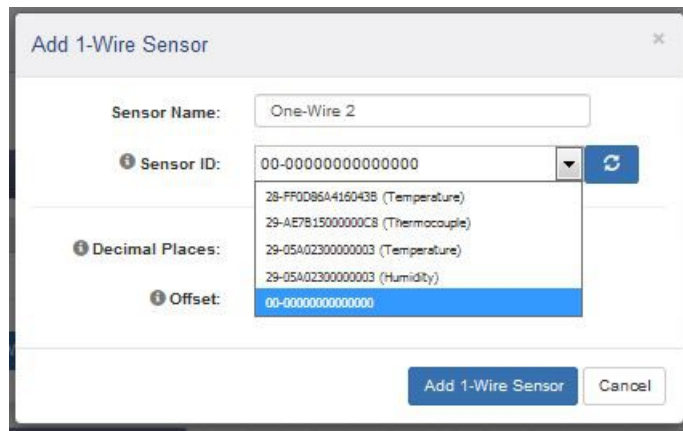

Enter a descriptive name for the sensor in the *Sensor Name* box such as “Outdoor Temperature”. The text in this field appears to the left of the corresponding temperature/humidity reading on the Control Page. This text also appears in the email status message when email notifications are enabled. When later defining the control logic, logging and other settings, this label appears in the pull-down lists of sensor resources. This field can be up to 27 characters in length.

Click ▼ to see a list of the connected 1-Wire sensors. The addresses of the non-associated sensors on the bus are shown in the drop-down list together with the sensor type of each sensor. Click the  button to make a fresh scan of the bus for sensors. For each sensor being added, select the appropriate address from the sensor address drop-down list. As 1-Wire sensors are added to the X-410, the addresses are removed from the pull-down ▼ list of available addresses. The X-DTHS-P temperature/humidity probe is a composite device and has a single 1-Wire address. The drop-down list will show both a temperature and a humidity ID with the same sensor address. Select appropriate ID (temperature or humidity) and the sensor address that matches the sensor address printed on the housing of the X-DTHS-P.

Alternatively, connect the sensors to the bus one at a time. The procedure is to start with one sensor and add it with the appropriate sensor name by selecting the sensor address within the drop-down list. Press *Submit*, connect a second sensor, and press the Refresh List button. Associate the second sensor to the appropriate sensor name. Continue this procedure until all sensors are set up.

The *General Settings* page has a setting to select the display for *Fahrenheit*, *Centigrade* or *Kelvin* units. 1-Wire addresses that have already been associated will not show in the list of available 1-Wire sensors.

1-Wire Options

Decimal Places

The number of digits to the right of the decimal point. This setting does not affect the accuracy of the underlying value. It is applied whenever the 1-Wire value is displayed in the Log files, Control Pages, Emails, Etc.

Local 1-Wire Options

Offset

If desired, an offset can be added to the 1-Wire sensor's measurement. By default, the offset is 0.0

$$\text{FinalValue} = \text{Sensor's Measured Value} + \text{Offset}$$

Remote 1-Wire Options

Device

For remote 1-Wire sensors, this settings specifies the device to which the remote 1-Wire sensor is connected.

Device's Sensor #

For remote 1-Wire Sensors, this settings specifies the 1-Wire number on the remote device. (Not the address of the 1-Wire sensor.)

Sensor Type

The X-410 can determine the type of 1-Wire sensor if it is connected directly to the device. For remote 1-Wire sensors the sensor type must be configured for the X-410 to know which type of sensor it is.

3.4.4 I/O Setup Tab > REGISTERS

Registers are working variables that can be changed externally through the *Control Page*, *XML requests*, or the BASIC script. Registers can allow a BASIC script to react to user input. These variables are considered to be floating point numbers, just like other variables in the BASIC script. Registers can also hold boolean information where “1”=true and “0”=false. This tab has settings for each of the configured Registers. By default, one register (*register1*) is pre-defined and is battery backed such that its value is retained across power loss. Registers appear in tables on the Registers tab and can be created, edited or deleted as needed. Up to 16 Local Registers can be created. The X-410 can also access remote registers found on other devices.

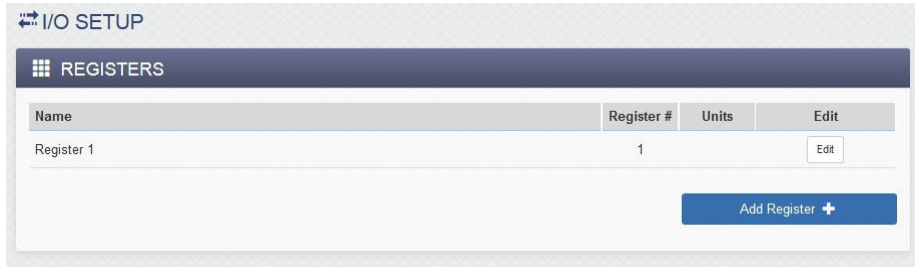

Register Options

Register Name

Text entered here will be displayed in the left column of the Control Page. Up to 27 characters may be entered here. The default text is “Register 1”. This is also the resource name used in a BASIC script. When later defining the control logic, logging and other settings, this label appears in the pull-down lists of Register resources.

Decimal Places

The number of digits displayed to the right of the decimal point. This does not affect the accuracy of the underlying value.

Units

Text entered here will be displayed on the right of the value when shown on the control page. This text does not affect the underlying value. Set the units to °F, ft, mph etc.

Minimum Value

If this register can be changed externally through the *Control Page*, *XML requests*, or the BASIC script it is may be useful to restrict the range of the register value. For example, a thermostat set-point register can be restricted to a minimum value.

Maximum Value

If this register can be changed externally through the *Control Page*, *XML requests*, or the BASIC script it is may be useful to restrict the range of the register value. For example, a thermostat set-point register can be restricted to a maximum value.

Initial Value

At power up, the register is set to this value if the Power Up State is set to Initial Value. The default is 0.0.

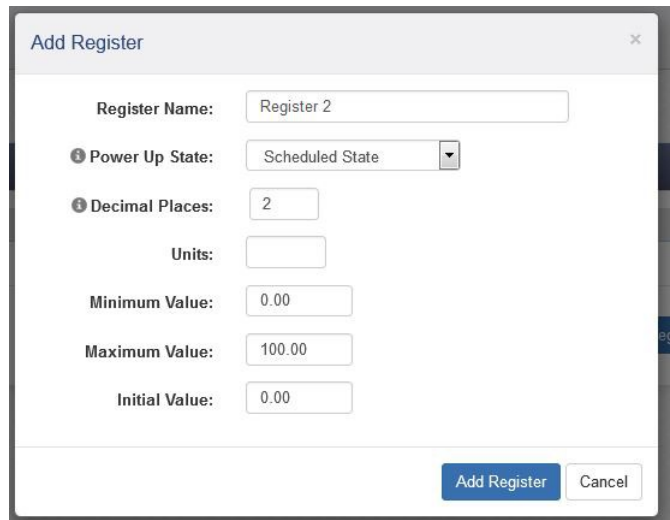

Local Register Options

Power Up State

At power-up the register is set to either an *Initial Value* (set below) or the *Scheduled State*. The Scheduled State will cause the register value to be defined by any scheduled tasks as if the power was always on.

Remote Register Options

Device

The device where the remote register is found.

Device's Sensor #

The register number on the remote device.

3.4.5 I/O Setup Tab > Vin

Vin reflects the voltage of the power source applied to the device and is measured internally. This page configures the name for the Vin voltage.

Note: With the X-410-E the power is provided over the Ethernet cable and the Vin+ monitor will show 0-volts. The X-410 can also monitor the power supply voltage of remote devices.

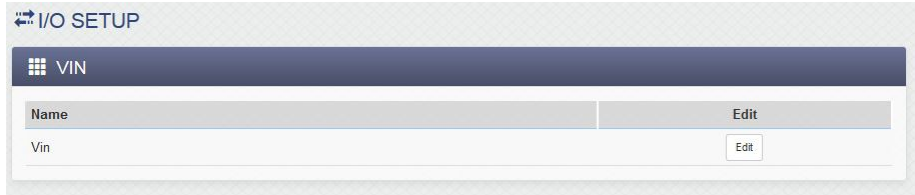

To edit the Vin name click *Edit*.

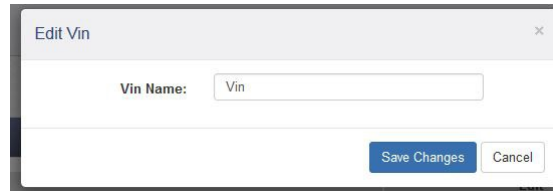

Vin Options

Vin Name

This text field is used to describe the power supply voltage value. By default it is set to “Vin.” The text appears to the left of the Vin status on the *Control Page*. This text will also appear in email messages when email alerts are enabled. This field may be up to 27 characters long. Set the name to a descriptive value such as “Power Supply” or “Battery Voltage”.

Remote Vin Options

Device

The device where the remote Vin is found.

3.4.6 I/O Setup Tab > TIMERS

Timers are I/O resources for measuring the time between events or generating controlled delays. The timers are essentially 24-bit, down counters with a one-second resolution. Timers appear in a table on the Timers tab and can be created, edited or deleted as needed. Up to 16 Timers can be created. The timer's value is accessible to Schedule and Conditional Tasks, BASIC scripts, Modbus and Control Page widgets. There are no remote timers.

A timer is started when an *Action* sets it to a non-zero value. The timer counts downwards and stops when it reaches zero. When the timer reaches zero, it generates a “timer expires” event. The *Timer Expires* event appears in the pull-down list ▼ of available *Triggers* for Scheduled and Conditional Tasks.

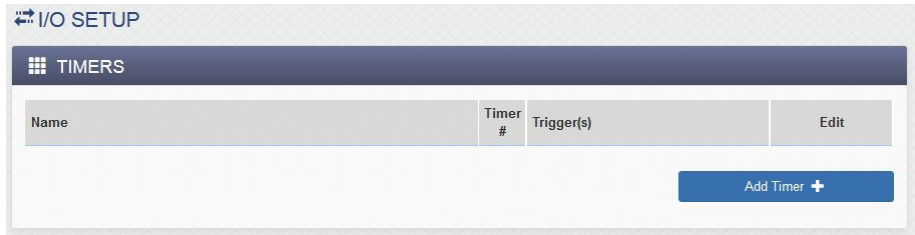

To add a timer click *Add Timer*.

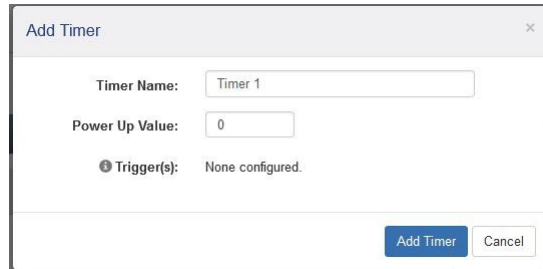

Timer Name

This text field is used to describe the timer. By default it is set to “Timer #”. The text appears to the left of the timer status on the *Control Page*. When later defining the control logic, logging and other settings, this label appears in the pull-down lists of Timer resources. This field may be up to 27 characters long. Set the name to a descriptive value such as “Warmup Delay”.

Power Up Value

At power-up the timer is set to this value. If the power-up value is something other than 0, then the timer will begin to count down.

Trigger(s)

Scheduled and Conditional Tasks can start or stop a Timer. Once a timer is added and named in this tab, it will appear in the pull-down list ▼ of available *Actions* for Scheduled and Conditional Tasks. The Action can be specified to either reset the counter (clear) or to set it to a fixed value (start). Actions which affect the timer are shown in the Trigger(s) field as shown in the example to the right for reference.

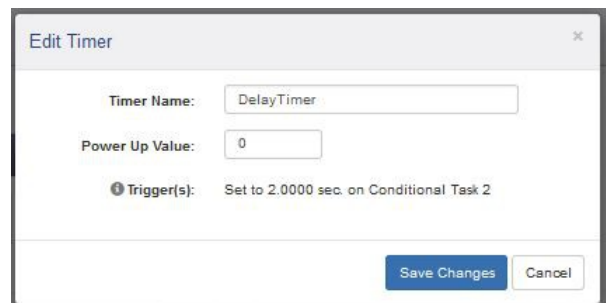

3.5 Control/Logic Tab

The sub-menus under the Control/Logic tab define the control and monitoring logic of the X-410. Conditional, Scheduled and Reboot tasks together with BASIC scripts are defined under this tab group.

3.5.1 Control/Logic Tab > TASK/FUNCTIONS

“Tasks” are logic functions that do specific things, such as turn a relay on or off under certain conditions or at certain times. Tasks are assigned a name, configured for the desired function, and saved. They appear in tables on the Tasks/Functions tab and can be created, edited or deleted as needed. Up to 50 Scheduled Tasks, 50 Conditional Tasks, and 16 Automatic Reboot Tasks can be created. Tasks can run one time, periodically or continually depending on its settings.

Tasks are defined using settings and pull-down menus to define the logic function without the need to learn boolean or other programming syntax. For more complex logic functions or logic functions not supported by this tab see *Section* Control Logic Tab > BASIC SCRIPT.

Scheduled tasks run at specific times or specific times and days of the week.

Conditional (boolean) tasks run only if specified logic conditions are met (i.e., If an input or sensor is “on” then perform an action).

Automatic Reboot tasks ping a device on the network, and if unresponsive, pulse a relay and/or send an email.

The Tasks/Functions tab has a status display which shows the current time of day and whether the *Normal* or *Override* schedule is running. An Override Schedule can temporarily cause certain Scheduled tasks to stop operating, such as for a holiday, and resume Normal schedule tasks after the Override Schedule expires. Up to 20 Override Schedules can be defined.

From this single page you can observe all of the tasks, their start times, run modes, triggers and actions.

For debug and testing, open the *Control Page* in another browser window (or another browser) and together with this page you can monitor what tasks are running and what they are doing in response to user input.

See Control Logic Examples Using Tasks/Functions for examples of using *Tasks* for control logic.

The screenshot displays the 'CONTROL/LOGIC SETUP' interface. At the top right, it shows the date and time: 'SAT, 06 FEB 2010 01:55:36' and the status 'CURRENTLY RUNNING NORMAL SCHEDULE'. The main content is divided into four sections:

- TASKS/FUNCTIONS**: A header section with a sub-section for 'SCHEDULED' tasks. It includes a table with columns: Name, Start Date/Time, Repeat, Actions, Next Occurance, Run Mode, and Edit. There is an 'Add Scheduled Task +' button.
- CONDITIONAL**: A sub-section for conditional tasks with a table with columns: Name, Trigger, Actions, and Edit. It includes an 'Add Conditional Task +' button.
- AUTOMATIC REBOOT**: A sub-section for automatic reboot tasks with a table with columns: Name, Ping, Action(s), Status, and Edit. One task is listed: 'Server Watchdog' with a ping of '192.168.1.165' and action 'Pulse Relay 2 Off 10 sec.'. Its status is 'Waiting for 1st Ping : 11 sec.'. It includes an 'Add Auto Reboot Task +' button.
- OVERRIDE SCHEDULES**: A sub-section for override schedules with a table with columns: Name, Start Date/Time, End Date/Time, Repeat, and Edit. One schedule is listed: 'Office Closed' with a start of '1st Sunday in January at 00:00' and a repeat of '2 Days After' for '1 Year'. It includes an 'Add Override Schedule +' button.

3.5.1.1 Scheduled Tasks

Scheduled tasks run at a specific time and on specific days of the week (e.g. turn a light on at 08:00, Monday through Friday). *Scheduled tasks* can be configured to be conditional with specified resources. Each *Scheduled task* can initiate up to three *Actions*. Actions are control outputs that “do” something, such as turn a relay on or off, send an email, send a SNMP trap or make a data log.

Scheduled Tasks appear in a table on the Control/Logic Setup tab and can be created, edited or deleted as needed. Up to 50 Scheduled Tasks can be created.



To add a Scheduled task, click *Add Scheduled Task*.

Task Name:

This text field is used to describe the task. By default it is set to “Scheduled Task 1”. This field may be up to 24 characters long. Set the name to a descriptive value such as “Unlock Front Door”.

Run Mode:

The *Run Mode* defines when the scheduled task is active.

| | |
|--------------------------|--|
| Always | Always active |
| Normal Schedule | Active, unless overridden by an override schedule. |
| Override Schedule | Active only during an override schedule. |
| Off | Never active (disabled). |

Start Date:

Using the drop-down boxes, select the month, day and year when the scheduled task is set to begin.

Start Time:

- **Set:** Select the time of day when the scheduled task will begin.
- **Sunrise:** Enter the offset (HH:MM) from sunrise. Choose *Before* or *After* sunrise.
- **Sunset:** Enter the offset (HH:MM) from sunset. Choose *Before* or *After* sunset.

Note: The sunrise and sunset times are automatically calculated based on the latitude and longitude settings made in the General Settings Tab > GENERAL INFORMATION tab.

Scheduled Task Condition (Optional):

Scheduled tasks can optionally be controlled (enabled) based on an I/O state. In order for I/O to appear in the condition pull-down menu ▼, the I/O must be first added and named in the I/O setup tab. The scheduled task only runs if the conditional I/O state evaluates as “true”.

If **None** is selected, no conditional logic will be evaluated.

If a **Relay** resource is selected, the following conditions are available:

| | |
|------------|---|
| ON | The scheduled task runs if the relay is On |
| OFF | The scheduled task runs if the relay is Off |

If a **Digital Input** resource is selected, the following conditions are available:

| | |
|------------|---|
| ON | The scheduled task runs if the input is On |
| OFF | The scheduled task runs if the input is Off |

If a **Digital Input Counter** resource is selected, the following conditions are available:

| | |
|-----------------------|--|
| Value = X.X | If the Counter value is equal to the setting, the compare is true. |
| Value >X.X | If the Counter value is greater than the setting, the compare is true. |
| Value < X.X | If the Counter value is less than the setting, the compare is true. |

If a **1-Wire Sensor** resource is selected, the following conditions are available:

| | |
|----------------------|---|
| Value ≥ X.X | If the sensor value is greater than or equal to the setting, the compare is true. |
| Value <X.X | If the sensor value is less than the setting, the compare is true. |

| | |
|-----------------|----------------------------|
| Deadband | Hysteresis for the compare |
|-----------------|----------------------------|

If a **Register** resource is selected, the following conditions are available:

| | |
|-----------------------|---|
| Value = X.X | If the Register value is equal to the setting, the compare is true. |
| Value >X.X | If the Register value is greater than the setting, the compare is true. |
| Value < X.X | If the Register value is less than the setting, the compare is true. |
| Deadband | Hysteresis for the compare |

If a **Vin** resource is selected, the following conditions are available:

| | |
|----------------------|--|
| Value ≥ X.X | If the Vin value is greater than or equal to the setting, the compare is true. |
| Value <X.X | If the Vin value is less than the setting, the compare is true. |
| Deadband | Hysteresis for the compare |

If a **Timer** resource is selected, the trigger is true when the timer expires (reaches 0).

The *Deadband* settings prevent alarms from triggering excessively when an analog value vacillates around the trigger point. With high alarms, the value must fall below the high alarm point, minus the *Deadband*, before the high alarm will be triggered again. Likewise the *Deadband* on the low alarm requires the value to rise above the low alarm point, plus the *Deadband*, before the low alarm will be triggered again.

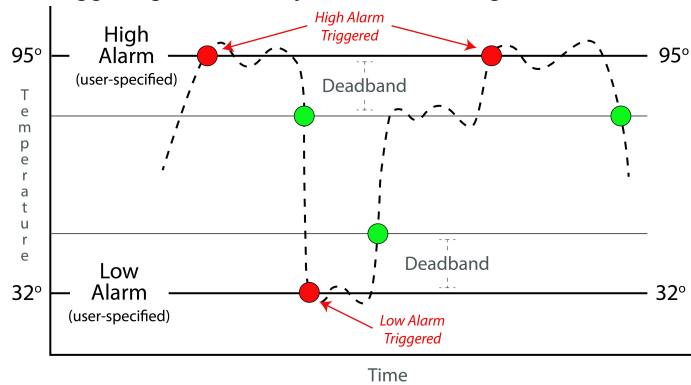

For example, if the *Deadband* is set to 1 degree, and a high alarm is occurs at 95 degrees, the *Deadband* ensures that once the high alarm is triggered, it won't trigger again until the temperature first drops below 94 degrees (95 – 1).

Scheduled Task Actions

Up to three actions can be specified for each Scheduled Task. Tasks can change the state of relays, counters, registers and other resources. To be available in the task setup pull-down menus ▼ for an *Action*, the resource must be first added and named in the I/O setup tab.

If **None** is selected, nothing is done when the task runs.

If a **Relay** Action is selected, the following actions are available:

| | |
|----------------------|-----------------------------------|
| On | The relay is turned on |
| Off | The relay is turned off |
| Pulse On | The relay is pulsed on (then off) |
| Toggle On/Off | The relay changes state |

| | |
|--|---|
| Condition-1 I/O Value | The relay is set to the state of the I/O in Condition-1 of the trigger. |
| Opposite of Condition-1 I/O Value | The relay is set to the opposite state of the I/O in Condition-1 of the trigger. |
| Pulse On (heartbeat mode) | The relay is pulsed continually over and over while the trigger is true. When the trigger changes to false, the relay will go off. This is useful for remote relays and detecting network drop-outs, etc. |

If a **Digital Input Counter** Action is selected, the following actions are available:

| | |
|------------------------|--|
| Log | The counter value is logged |
| Reset | The counter is reset to 0 |
| Log & Reset | The counter value is logged, then reset to 0 |

If a **Register** Action is selected, the following actions are available:

| | |
|---------------------|---|
| Set-To | Set the value of the register to a specific value |
| Increment By | Increment the register by the specified value |
| Decrement By | Decrement the register by the specified value |

If a **Timer** Action is selected, the following actions are available:

| | |
|---------------------------|--------------------------------------|
| Start Timer | Set the timer to the specified value |
| Clear (stop) Timer | Reset the timer to 0 |

If a **Log** Action is selected, the following actions are available:

| | |
|-----------------------|---|
| Log | A data log is made of selected resources: Logging Tab > LOG I/O |
| Reset Log | Clear (Erase) the log file |
| Pause Logging | Temporarily pause all logging to the log file. |
| Resume Logging | Resume logging after previously pausing it. |

If an **Email** Action is selected, an email is sent when the task runs.

| | |
|----------------------|---|
| Send Email To | With the drop-down box, select which Email address(es) to use. The address list is configured in the General Settings Tab > EMAIL SETTINGS tab. |
|----------------------|---|

If **SNMP TRAP** Action is selected, the following actions are available:

| | |
|--|---|
| Send SNMP Trap for Cond 1 I/O value | Send SNMP trap to configured SNMP Managers for I/O in Condition 1 |
| Send SNMP Trap for Cond 2 I/O value | Send SNMP trap to configured SNMP Managers for I/O in Condition 2 |

| | |
|--|--|
| Send SNMP Trap for Cond 1 and 2 I/O value | Send SNMP trap to configured SNMP Managers for I/O in Condition 1 and 2. |
|--|--|

If **SNMP NOTIFICATION** Action is selected, the following actions are available:

| | |
|--|--|
| Send SNMP Notification for Cond 1 I/O value | Send SNMP notification to configured SNMP Managers for I/O in Condition 1 |
| Send SNMP Notification for Cond 2 I/O value | Send SNMP notification to configured SNMP Managers for I/O in Condition 2 |
| Send SNMP Notification for Cond 1 and 2 I/O value | Send SNMP notification to configured SNMP Managers for I/O in Condition 1 and 2. |

If **Remote Services Notification** Action is selected:

| | |
|--|---|
| Send Device State to Remote Service | The local device state is sent to the remote service's server, if configured. |
|--|---|

If **Push I/O State to Remote Receiver Devices Action** is selected:

| | |
|---|---|
| Push I/O State to Remote Receiver Devices Action | The state of the X-410 is sent to all remote devices configured to receive such messages. |
|---|---|

If **Set I/O Color** Action is selected, an I/O can be chosen and it's status color in the control page can be changed.

Repeat

The *Scheduled Task* is repeated:

| | |
|------------------|--|
| No Repeat | Runs only once |
| Seconds | Repeats once every X seconds |
| Minutes | Repeats once every X minutes |
| Hourly | Repeats once every X hours |
| Daily | Repeats once every X days |
| Weekly | Repeats weekly on the selected days of the week |
| Monthly | Repeats monthly either on selected days of the month, or the 1st Sunday, etc. |
| Yearly | Repeats yearly on the 1st, 2nd, 4th Day of the Start Date Month, or the 1st, 2nd, 4th Day of the Start Date Every month that year. |

End Repeat

Define when the scheduled task should stop repeating:

| | |
|--------------------------------|---|
| Never (Continuous Task) | Task never stops repeating |
| Date/Time | Task will stop repeating at the specified date and time |

3.5.1.2 Conditional Tasks

Conditional Tasks occur (run) if certain conditions are met. *Conditional Tasks* are made by comparing specified resources using simple and/or (boolean) logic. For example, if a digital input is on or off, turn a relay on or off. *Conditional Tasks* can be configured to be active continually or only during specific time periods each day/week. Each *Conditional Task* can initiate up to three *Actions*. Actions are control outputs that “do” something such as turn a relay on or off, send an email, send a SNMP trap or make a data log. *Conditional Tasks* are event driven and do not evaluate asynchronously. Their triggers are only evaluated when the conditions of the trigger change state. Conditional Tasks appear in a table on the Control/Logic Setup tab and can be created, edited or deleted as needed. Up to 50 *Conditional Tasks* can be created.

To add a Conditional Task, click *Add Conditional Task*.

Task Name

This text field is used to describe the task. By default it is set to “Conditional Task 1”. This field may be up to 24 characters long. Set the name to a descriptive value such as “High Temp Shutdown”.

Conditional Task Triggers

The “Trigger” section is a boolean logic comparison of two I/O. Triggers ONLY occur when the conditions change to true. The logic operations are event driven, and are not combinational. Conditions must change from false and back to true to re-trigger. The I/O must be first added and named in the I/O setup tab to appear in the task pull-down menus ▼ as a trigger.

The two conditions (arguments) can be evaluated with “AND” or “OR” boolean logic. If both triggers are set to *None*, the Conditional Task is never evaluated. If one trigger is set to *None*, only one condition is evaluated for a True or False state.

If a **Relay** is selected the following logic states are available:

| | |
|----------------|--|
| On | The trigger is true if the relay is on |
| Off | The trigger is true if the relay is off |
| Changes | The trigger is true if the relay changes state |

If a **Digital Input** is selected the following logic states are available:

| | |
|------------|---|
| On | The trigger is true if the digital input is on |
| Off | The trigger is true if the digital input is off |

| | |
|----------------|--|
| Changes | The trigger is true if the digital input changes state |
|----------------|--|

If a **Digital Input Counter** is selected, the following conditions are available:

| | |
|-----------------------|---|
| Value =X.X | If the Counter value is equal to the setting, the compare is true |
| Value >X.X | If the Counter value is greater than the setting, the compare is true |
| Value < X.X | If the Counter value is less than the setting, the compare is true. |

If a **1-Wire Sensor** selected, the following conditions are available:

| | |
|----------------------|---|
| Value ≥ X.X | If the sensor value is greater than or equal to the setting, the compare is true. |
| Value <X.X | If the sensor value is less than the setting, the compare is true |
| Deadband | Hysteresis for the compare |

If a **Register** is selected, the following conditions are available:

| | |
|-----------------------|---|
| Value =X.X | If the Register value is equal to the setting, the compare is true |
| Value >X.X | If the Register value is greater than the setting, the compare is true. |
| Value < X.X | If the Register value is less than the setting, the compare is true. |

If a **Vin** selected, the following conditions are available:

| | |
|----------------------|--|
| Value ≥ X.X | If the Vin value is greater than or equal to the setting, the compare is true. |
| Value <X.X | If the Vin value is less than the setting, the compare is true. |
| Deadband | Hysteresis for the compare |

If a **Timer** selected, the trigger is true when the timer expires (reaches 0).

The Deadband settings prevent alarms from triggering excessively when an analog value vacillates around the trigger point. With high alarms, the value must fall below the high alarm point, minus the *Deadband*, before the high alarm will be triggered again. Likewise the *Deadband* on the low alarm requires the value to rise above the low alarm point, plus the *Deadband*, before the low alarm will be triggered again.

For example, if the *Deadband* is set to 1 degree, and a high alarm is occurs at 95 degrees, the

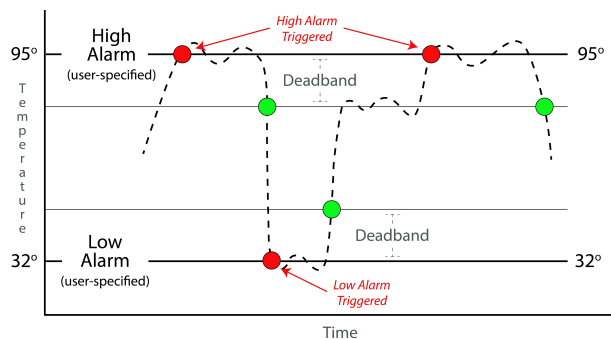

Deadband ensures that once the high alarm is triggered, it won't trigger again until the temperature first drops below 94 degrees (95 – 1).

Conditional During Time

Conditional tasks can be configured to run continually or during specific days each week.

Always

Runs continually.

Set Time

Specify the time interval and day(s), when this task will evaluate.

Note: If the Start Time begins after the end time (i.e., Start Time: 8:00pm, End Time: 6:00am), then the time interval will start and continue through the end time of the next day.

During: Always Set Time

Start Time:(HH:MM:SS) 08 : 00 : 00

Start Day(s) of Week: Su M Tu W Th F Sa

End Time:(HH:MM:SS) 09 : 00 : 00

Conditional Task Actions

Up to three actions can be specified for each Conditional Task. Tasks can change the state of relays, counters, registers and other I/O. To be available in the task setup pull-down menus ▼ for an *Action* the resource must be first added and named in the I/O setup tab.

If a **None** Action is selected, nothing is done when the task runs

If a **Relay** Action is selected the following actions are available:

| | |
|--|---|
| On | The relay is turned on |
| Off | The relay is turned off |
| Pulse On | The relay is pulsed on (then off) |
| Toggle On/Off | The relay changes state |
| Condition-1 I/O Value | The relay is set to the state of condition 1 I/O |
| Opposite of Condition-1 I/O Value | The relay is set to the opposite state of condition 1 I/O |
| Pulse On (heartbeat mode) | The relay is pulsed continually over and over while the trigger is true. When the trigger changes to false, the relay will go off. This is useful for remote relays and detecting network drop-outs, etc. |

If a **Digital Input Counter** Action is selected, the following actions are available:

| | |
|------------------------|--|
| Log | The counter value is logged |
| Reset | The counter is reset to 0 |
| Log & Reset | The counter value is logged, then reset to 0 |

If a Register Action is selected, the following actions are available:

| | |
|---------------|---|
| Set-To | Set the value of the register to a specific value |
|---------------|---|

| | |
|---------------------|---|
| | |
| Increment By | Increment the register by the specified value |
| Decrement By | Decrement the register by the specified value |

If a **Timer** Action is selected the following actions are available:

| | |
|--------------------|--------------------------------------|
| Start Timer | Set the timer to the specified value |
| Clear Timer | Resets the timer to 0 |

If a **Log** Action is selected the following actions are available:

| | |
|-----------------------|--|
| Log | A data log is made of the resources enabled in Logging Tab > LOG I/O |
| Reset Log | Clear (Erase) the log file |
| Pause Logging | Temporarily pause all logging to the log file |
| Resume Logging | Resume logging after previously pausing it |

If an **Email** Action is selected, an email is sent when the task runs.

| | |
|----------------------|---|
| Send Email To | With the drop down box, select the Email address to use. The address list is configured in the General Settings Tab > EMAIL SETTINGS tab. |
|----------------------|---|

If **SNMP TRAP** Action is selected the following actions are available:

| | |
|--|---|
| Send SNMP Trap for Cond 1 I/O value | Send SNMP Trap to configured SNMP Managers for I/O in Condition 1 |
| Send SNMP Trap for Cond 2 I/O value | Send SNMP Trap to configured SNMP Managers for I/O in Condition 2 |
| Send SNMP Trap for Cond 1 and 2 I/O value | Send SNMP Trap to configured SNMP Managers for I/O in Condition 1 and 2 |

If **SNMP NOTIFICATION** Action is selected the following actions are available:

| | |
|--|--|
| Send SNMP Notification for Cond 1 I/O value | Send SNMP Notification to configured SNMP Managers for I/O in Condition 1 |
| Send SNMP Notification for Cond 2 I/O value | Send SNMP Notification to configured SNMP Managers for I/O in Condition 2 |
| Send SNMP Notification for Cond 1 and 2 I/O value | Send SNMP Notification to configured SNMP Managers for I/O in Condition 1 and 2. |

If **Remote Services Notification** Action is selected:

| | |
|--|---|
| Send Device State to Remote Service | The local device state is sent to the remote services server if configured. |
|--|---|

If **Push I/O State to Remote Receiver Devices** Action is selected:

| | |
|---|---|
| Push I/O State to Remote Receiver Devices Action | The state of the X-410 is sent to all remote devices configured to receive such messages. |
|---|---|

If **Set I/O Color** Action is selected, an I/O's status color in the Control Page can be changed.

3.5.1.3 Automatic Reboot Tasks

The X-410 can function as a reboot controller with fully configurable setup options. It can be used to reboot servers, computers, satellite modems and other devices if they fail to respond to pings sent from the X-410. The X-410 pings a device on a network, and if unresponsive, starts, stops, or reboots the device connected to a relay. Automatic Reboot Tasks appear in a table on the Control/Logic Setup tab and can be created, edited or deleted as needed. Up to 16 Reboot Tasks can be created. The status field in each *Reboot Task* dynamically shows what the task is doing. For example, status messages such as: "Waiting for 1st Ping: 25 sec", or "*Pinging, Failed Pings: 5, Reboot Attempts:10*" will appear.

There are three ways that the X-410 can be wired to reboot a device. All three reboot methods have different requirements for wiring connections and relay timing.

Connect an X-410 relay series with the power source of the device. Simply switch the power off then on. If the AC line voltage is to be switched off, a line-voltage interposer relay will be needed since the relays in the X-410 are rated only for low voltage operation.

If the DC power to a modem or other device is to be switched off, the DC connections can be made to one of the internal relays in the X-410. The 4-relays in the X-410 share a common connection, so in this case the other 3-relays cannot be connected to other loads.

If the other relays are needed, use an interposer relay to switch the DC power to the device to be rebooted.

1. Connect an X-410 relay in parallel with the on/off switch of the device. This is useful for devices with momentary power buttons that will not automatically start operating when power is applied. These devices require a user to momentarily press a switch before the device will boot. An interposer relay may or may not be needed.
2. Connect an X-410 relay to the reset button or circuit of a device. In this configuration, the X-410 does not power down the device, but simply forces the device to reset.

| AUTOMATIC REBOOT ⓘ | | | | | Add Auto Reboot Task + |
|--------------------|---------------|---------------------------|--------------------------------|------|------------------------|
| Name | Ping | Action(s) | Status | Edit | |
| Server Watchdog | 192.168.1.165 | Pulse Relay 2 Off 10 sec. | Waiting for 1st Ping : 25 sec. | Edit | X |

To add an Automatic Reboot task, click *Add Auto Reboot Task*.

Task Name

This text field is used to describe the task. By default it is set to "Reboot Task 1". This field may be up to 24 characters long. Set the name to a descriptive value such as "Server Watchdog".

Ping IP Address/Name

This is the IP address or hostname that the X-410 will ping. This is typically the IP address or hostname of the device that will be re-booted upon failure (such as a server, router, computer, etc.). It could however, be the address of a device on the opposite side of a communications link. This is useful to auto reboot communications devices such as CSU/DSUs, satellite modems, routers, etc.

Ping Interval

This is the time interval (in seconds) between successful ping requests. This time can be set from 1 to 6000 seconds (100 minutes or 1.67 hours).

Unsuccessful Ping Interval

When ping requests fail (no response from device), it may be desirable to begin pinging at a shorter time interval. This allows the X-410 to determine in less time that the device is not functioning. After each unsuccessful ping, the X-410 will wait this time interval (in seconds) before the next ping attempt. This time can be set from 1 to 6000 seconds (100 minutes or 1.67 hours).

Delay Before First Ping After Reboot

When the X-410 determines it's time to reboot a device due to loss of communication, it will wait this time interval (in seconds) before beginning to ping the device after the relays the device is connected to have power cycled the device. This time delay allows the device to boot before being pinged. This time can be set from 0 to 6000 seconds (100 minutes or 1.67 hours).

Delay Before First Ping After Reboot

The device will be rebooted after this number of consecutive ping failures. This number can be set between 1 and 255.

Max Reboot Attempts

After the device has been re-booted this number of times without any successful pings, it is assumed that there are problems with the device and the X-410 will no longer attempt to reboot the device. At this point, the X-410 will leave the device on and continue pinging the device, but will not reboot the device anymore. Once the device responds to pings again, the X-410 will return to pinging and rebooting the device. This number can be set between 2 and 255.

Reboot Timer (T)

Timer value used in reboot option. If the power source to the device is controlled by a relay, this is the time the power is switched off. If the relay is connected to the on/off switch, this is the time the on/off switch is momentarily activated. If the relay is connected to the reset circuit, this is the time the reset is momentarily activated. This time can be set from 1 to 6000 seconds (100 minutes or 1.67 hours).

Reboot Options:

| | |
|---|---|
| Pulse Relay Off T seconds | Connect the NO contacts of the interposer relay to the AC power line of the device being monitored. If the device fails to respond to pings, the power is turned off, then on. |
| Pulse Relay On T seconds | Connect the NC contacts of an interposer relay to the AC power line of the device being monitored. If the device fails to respond to pings, the power is turned off, then on. Connect the NO contacts of the relay to the reset circuit of the device being monitored. If the device fails to respond to pings, the reset is momentarily activated. |
| Turn Relay OFF until successful ping resumes | If the device is unresponsive, stop the device connected to a relay |
| Turn Relay ON until successful ping resumes | If the device is unresponsive, start the device connected to a relay |

Relay/Register

With the drop-down box, select the relay (or register) from the list that will reboot the monitored device. A Register can be used in applications where more complex logic or control is needed and a Task monitors the Register to initiate a reboot. Use a Register and Task for example, if reboots are wanted only on a schedule during certain times each day.

Email Notifications

Email notifications of a reboot sequence can be *Enabled* or *Disabled*. If enabled, an email will be sent whenever the device is rebooted. The email will actually be queued until the device is back up, in case the device is needed in order to send a successful email.

Select Email Address

With the drop-down box, select the Email address to send reboot notifications. The address list is configured in the General Settings Tab > EMAIL SETTINGS tab.

3.5.1.4 Override Schedules

Override Schedules temporarily disable Scheduled Tasks that are configured for *Normal Schedule* in the Run Mode column, and enables any Scheduled Tasks that are set to *Override Schedule*. Tasks that are set to *Always* will not be effected by this schedule. Override schedules are especially helpful for creating holiday schedules. Override Schedules appear in a table on the Control/Logic Setup tab and can be created, edited or deleted as needed. The X-410 can support up to 20 different override schedules.

A task running on a Normal schedule is setup by an Administrator (with *Administrator* credentials) and can be used for example, to open door locks during office hours. Override schedules allow the normal schedule to be temporarily disabled without disturbing the underlying schedule. For example, an employee (with *Manager* credentials) can temporarily change the schedule to accommodate a special holiday without the need to change or adjust the Normal schedule.

An example of this would be the 1st of January. An override schedule could be created that starts 00:00 on January 1st and ends at 23:59 on January 1st. This override schedule would stop normally scheduled tasks from running every year on the 1st of January.

Override schedules are repeated annually, meaning the event will happen at the configured time every year.

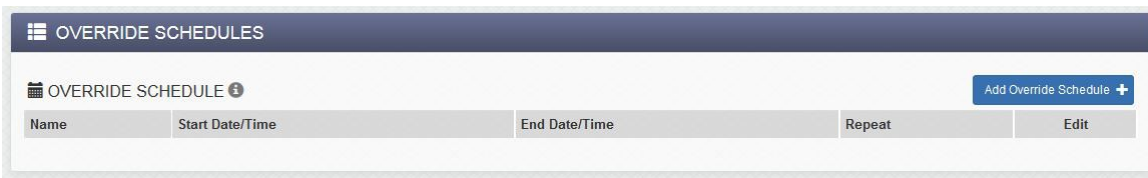

To add an Override Schedule, click *Add Override Schedule*. Click to edit an override schedule, click to delete an override schedule.

Name:

This text field is used to describe the override schedule. By default it is set to "Override Schedule 1". This field may be up to 24 characters long. Set the name to a descriptive value such as "Office Closed".

Start Day/Time:

Different options will appear depending on the option you choose:

- Choose **On the:** to enter a start day of the month, start time, and duration (days) for the override schedule.

Duration

How many days from the Start Day should the override schedule be in effect.

- Choose **On:** to enter a start date and time, and an end date and time for the override schedule.

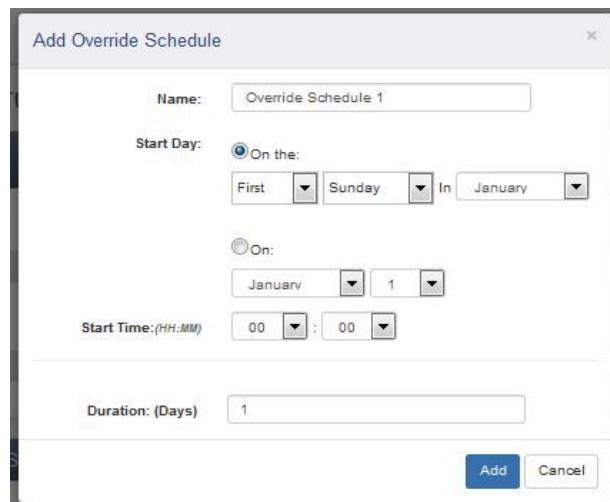

3.5.2 Control Logic Tab > BASIC SCRIPT

The X-410 can run simple custom programs written in a modified version of BASIC. This page is used to load and execute these programs. Before it can be loaded to the X-410, a script must first be prepared as a text (.txt) file. The file must then be uploaded to X-410 via the *Basic Script* tab.

The maximum size of script that can be uploaded to the device is 4K bytes. Information on writing a basic program for the X-410 can be found in *Section Basic Scripts*. See Control logic examples using BASIC Scripts for examples of BASIC scripts.

The screenshot shows a web interface for the X-410 device. At the top, there is a navigation bar with a hamburger menu icon and the text 'CONTROL/LOGIC'. Below this is a sub-header 'BASIC SCRIPT'. The main content area is divided into several sections: 1. 'Currently loaded script:' followed by a large empty text box. 2. 'Basic Script File' with a button labeled 'No file chosen'. 3. 'Interpreter Status' with a sub-label 'Current state of basic interpreter.' and a text box containing 'No Script Loaded.'. 4. 'Run Script:' with two radio buttons, 'Yes' and 'No', where 'No' is selected. At the bottom of the interface are two buttons: 'Submit' and 'Reset'.

Note: An ASCII standard text file format should be used, such as Windows Notepad, Programmer's Notepad, vi, or other text editor that output the file as a .txt. Rich Text Format (.rtf) used by Microsoft WordPad is NOT compatible.

Currently Loaded Script

This field displays the .txt file that is uploaded to the X-410. The script (text) displayed in this screen cannot be edited. In order to edit any script, it must be edited in the .txt file and uploaded to the unit again.

Basic Script File

To upload a BASIC script file to the device, click *Basic Script File*. A file upload dialog box opens which allows you to choose the file to upload. To upload the script, click *Open*.

Interpreter Status

This field displays whether the program is continuing to run, has stopped or finished, or if there are errors contained in the script. If there are errors in the script, the line on which the error occurred is displayed.

Run Script

This option selects whether or not the selected script will be run after it has been uploaded. The Submit button must be clicked to run the script.

BASIC I/O Tokens

The X-410's I/O resources are not fixed. After 1-Wire sensors, registers, counters, and other I/O are added and named, they can be controlled and monitored within BASIC scripts. BASIC scripts must reference I/O resources such as digital inputs and relays in the form of "io.name" where "name" is the resource name defined when the resource was added in the I/O Setup Tab. If the resource name has embedded spaces, they must be removed in the io.name statement. The first character must be lower case. For example, if a relay is named "Warehouse Fan", the fan can be turned on with the BASIC statement "LET io.warehouseFan = 1". If a resource name is changed during development and testing, the resource name in the BASIC scrip must be renamed to match.

The button displays a list of all of the I/O resources currently available together with the equivalent token to be used in BASIC scripts to reference the respective I/O resource.

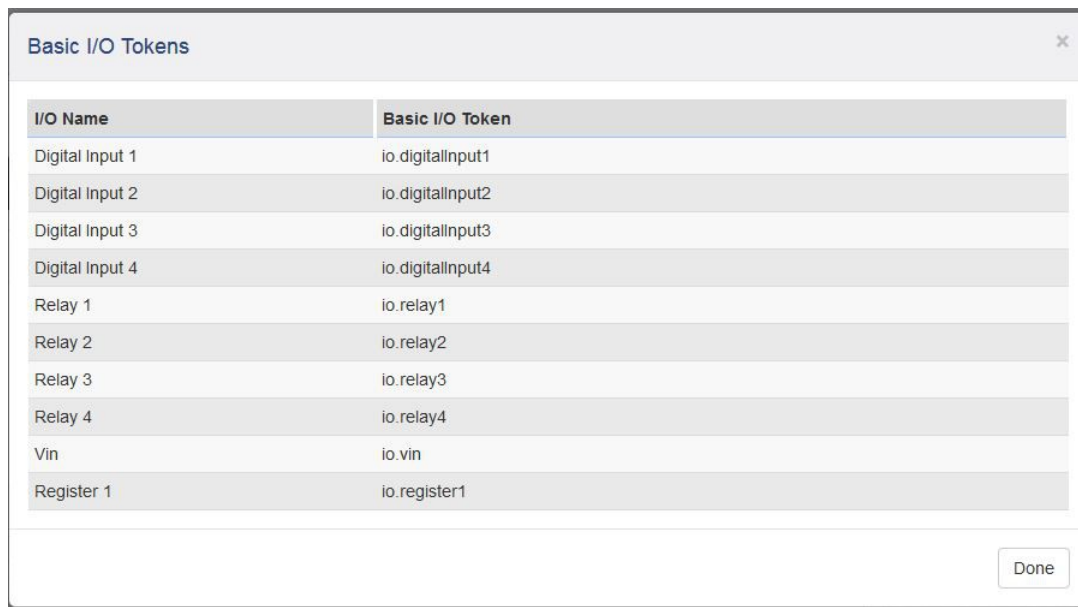

| I/O Name | Basic I/O Token |
|-----------------|------------------|
| Digital Input 1 | io.digitalInput1 |
| Digital Input 2 | io.digitalInput2 |
| Digital Input 3 | io.digitalInput3 |
| Digital Input 4 | io.digitalInput4 |
| Relay 1 | io.relay1 |
| Relay 2 | io.relay2 |
| Relay 3 | io.relay3 |
| Relay 4 | io.relay4 |
| Vin | io.vin |
| Register 1 | io.register1 |

Done

3.6 Logging Tab

Record data such as changes in I/O state, sensor data, and events. Both periodic and event-based logging are supported. The logged data is stored in internal nonvolatile memory and can be retrieved by entering the command `http://{X-410 IP address}/log.txt`. For more information on logging, see *Section Log Files*.

The X-410 can make up to 30 logs per second with event-driven logging. Each log entry has a time stamp with millisecond resolution. Two Conditional Task actions are available to pause and resume logging.

The log is stored in non-volatile, flash memory using a circular buffer (old data is over written). 512 kB of memory space is reserved for logging. Log entries are composed of the following components, 30-byte header, 16-bytes for relays, 16-bytes for inputs, and 4 bytes for each analog value being logged (counters, 1-Wire sensors, vin, registers, etc). The space allocated for relays and inputs does not change depending on whether any relays or inputs are being logged.

Note: Changing the log settings will erase the current log file.

3.6.1 Logging Tab > GENERAL LOGGING SETTINGS

The screenshot shows the 'LOGGING' section of the web interface. Under the 'GENERAL LOGGING SETTINGS' header, there are four main settings:

- Enable Logging:** A radio button interface with 'Yes' and 'No' options. 'No' is selected.
- Start Time:** Three dropdown menus for hours, minutes, and seconds, all set to '00'.
- Interval:** A text input field containing '60' and four radio buttons for 'Mins', 'Hours', 'Days', and 'Event Only'. 'Mins' is selected.
- Next Log Time:** A text input field containing 'Disabled'.

Enable Logging

When this option is set to *Yes*, the X-410 will record data as configured on this page. The default setting for this option is *No*.

Note: This option controls data logging, but not system logging. System logging is always enabled.

Start Time

If a logging interval is specified (periodic logging rather than event logging), logging will occur relative to this start time. For example, if the start time is 01:00 and the Interval is 6 hours, logging will occur at 01:00, 07:00, 13:00, and 19:00. Start time is specified in 24-hour time format.

Interval

This field is used to specify the time period of logging. A numerical value is entered into the text field, and the unit of time is selected using the adjacent radio buttons. The range of values in this field is 1-60. Time units are *Minutes*, *Hours*, and *Days*. Select *Event Only* to disable periodic logging.

Next Log Time

This field shows when the next periodic log event is scheduled to occur. If logging is disabled, the next log time will indicate "Disabled." If logging is enabled, but periodic logging is disabled (by selecting *Event Only*) the next log time will indicate "Event Logging Only."

Note: This information is updated only when the page is refreshed.

3.6.1.1 Logging Tab > LOG I/O

This setup page is used to select which resources are periodically logged on a fixed schedule and/or which resources asynchronously trigger logging. The resources are grouped into five sections.

When a periodic log occurs, each resource which has its *Log* check-box enabled will be included in the periodic log. If a resource has its *Trigger Log Event* check-box enabled, a log will asynchronously occur when the resource changes its state or value.

☰
LOG I/O

☑ RELAYS

| Name | Log | Trigger Log Event |
|---------|--------------------------|--------------------------|
| Relay 1 | <input type="checkbox"/> | <input type="checkbox"/> |
| Relay 2 | <input type="checkbox"/> | <input type="checkbox"/> |
| Relay 3 | <input type="checkbox"/> | <input type="checkbox"/> |
| Relay 4 | <input type="checkbox"/> | <input type="checkbox"/> |

☑ DIGITAL INPUTS

| Name | Log | Counter/Freq | On Time | Total On Time | Trigger Log Event |
|-----------------|--------------------------|--------------|---------|---------------|--------------------------|
| Digital Input 1 | <input type="checkbox"/> | | | | <input type="checkbox"/> |
| Digital Input 2 | <input type="checkbox"/> | | | | <input type="checkbox"/> |
| Digital Input 3 | <input type="checkbox"/> | | | | <input type="checkbox"/> |
| Digital Input 4 | <input type="checkbox"/> | | | | <input type="checkbox"/> |

☑ ONE-WIRE SENSORS

| Name | Log | Trigger Log Event | Delta |
|--------------------------|--------------------------|--------------------------|-------|
| Maxim DS18B20 | <input type="checkbox"/> | <input type="checkbox"/> | 2.00 |
| One-Wire Thermocouple #1 | <input type="checkbox"/> | <input type="checkbox"/> | 2.00 |
| One-Wire Thermocouple #2 | <input type="checkbox"/> | <input type="checkbox"/> | 2.00 |
| X-DTHS-P Humidity | <input type="checkbox"/> | <input type="checkbox"/> | 2.00 |
| X-DTHS-P R100K Humidity | <input type="checkbox"/> | <input type="checkbox"/> | 2.00 |
| X-DTHS-P R100K temp | <input type="checkbox"/> | <input type="checkbox"/> | 2.00 |
| X-DTHS-P Temp | <input type="checkbox"/> | <input type="checkbox"/> | 2.00 |

☑ REGISTERS

| Name | Log | Trigger Log Event | Delta |
|------------|--------------------------|--------------------------|-------|
| Register 1 | <input type="checkbox"/> | <input type="checkbox"/> | 2.00 |

☑ VIN

| Name | Log | Trigger Log Event | Delta |
|------|--------------------------|--------------------------|-------|
| Vin | <input type="checkbox"/> | <input type="checkbox"/> | 2.00 |

Asynchronous Log Events

- Relays** Logging will occur whenever the selected relay state changes
- Digital Inputs** Logging will occur whenever the input state changes
- Counter Inputs** Logging will occur whenever the counter changes
- 1-Wire Sensors** Logging will occur whenever the sensor changes by the trigger delta
- Registers** Logging will occur whenever the Register changes by the trigger delta
- Vin** Logging will occur whenever the Vin voltage changes by the trigger delta

Trigger and Delta

Analog resources log data when the value changes by the amount specified in the *Delta* fields. The default setting for these fields is shown below.

| Sensor | Trigger Delta |
|-------------|---------------|
| Counters | 2 |
| Vin | 2.0 V |
| Temperature | 2° |
| Humidity | 2% |

3.6.1.2 Diagnostic Settings

XML, MODBUS and SNMP requests received by the X-410 can generate a log entry. Each communication protocol has a check-box to enable logging for that protocol.

🔧 **DIAGNOSTIC SETTINGS**

Log XML Requests: Enable

Log MODBUS Requests: Enable

Log SNMP Requests: Enable

Exclude Logged Requests: None Reads Writes

✉ **SEND LOG FILE**

Daily Send Time (HH:MM): 23 : 00

Email Log File: Enable

FTP Upload Log File: Enable

Submit
Reset

Exclude Logged Requests

When logging is enabled for XML requests, Modbus requests, or SNMP requests, you can filter out *Reads* (such as reading the Digital I/O states via an XML request) or *Writes* (such as changing the output state via an XML command).

On the *Control Page* setup tab, you can specify the refresh rate of the Control Page. Each time the page is refreshed, an XML request is sent and logged as a *Read*. Since the default refresh rate is 3 seconds, the log file can get cluttered by many XML request logs. By filtering out *Reads*, refresh requests will not be logged. Likewise, by selecting *Writes*, write requests will not be logged. The default selection is *None*.

3.6.1.3 Send Log File

The X-410 can be configured to send its log file to a remote server at a specific time once per day. The file can be emailed and/or uploaded to an FTP server. Only new log entries since the last successful upload are sent, the log file is not deleted.

Daily Send Time

Select the time each day (24-hour format) the log file is to be sent.

Email Log File

If this check-box is enabled, the log file is sent in an email once each day. With the drop-down box, select the email address to send the daily log. The address list is configured in *General Settings Tab > EMAIL SETTINGS*.

The *Test Log Email* button causes the log file to be emailed immediately, without waiting until the daily send time.

The screenshot shows a configuration form for 'Email Log File'. It includes a checked checkbox labeled 'Enable', a dropdown menu for 'Email Address', and a 'Test Log Email' button.

FTP Upload Log File

If this check-box is enabled, the log file is sent to an FTP server once each day.

The screenshot shows a configuration form for 'FTP Upload Log File'. It includes a checked checkbox labeled 'Enable', and several input fields: 'Host Name' (192.168.1.15), 'Connection Security' (None), 'Port' (21), 'User name' (username), 'Password' (masked with dots), and 'FTP Path/Filename' (logs/log.txt). A 'Test FTP Log' button is also present.

Host Name

The IP address or hostname of the remote FTP server is entered here. The default value is 192.168.1.15

Connection Security

Choose *None*, *Implicit TLS* or *Explicit TLS*. The security and port number must be configured to match the FTP server. *None* uses no encryption on the connection. *Implicit TLS* uses SSL to encrypt the channel before any FTP commands are sent or received. *Explicit TLS* allows the connection to start unencrypted and then upgrades the connection to encrypted through FTP commands.

Port

The TCP port number of the FTP server. This must match the TCP port set in the FTP server. The valid range is 1 to 65535. The default port number is 21.

User name

The username for connecting to the FTP server.

Password

If the FTP server requires a password, the password is entered here.

FTP Path/Filename

When uploading the log file to an FTP server, the FTP server will have a default location where it will place the log file. Here is where the name of the log file is defined. If there is a subdirectory where the log file should go, that should be defined here as well. For example, if the FTP server by default places all files uploaded to it in the directory /uploads and we wanted the X-410 to upload its log files to a subdirectory called /logs, then we would enter "logs/log.txt".

The actual filename used for saving the file on the FTP server will be the specified filename with the date and time appended to it. For example log.txt would be log_YYYYMMDDHHMMSS.txt where YYYY is the year, MM is the month, DD is the day of the month, HH is the hour, MM is the minutes, and SS is the seconds. This date and time comes from the X-410, and it's the time that the X-410 uploaded the file.

Test FTP Log

The *Test FTP Email* button causes the log file to be sent immediately, without waiting until the daily send time. If nothing is in the log file, no file will be sent. Once tested, the log information sent in the test file will not be sent in the following file as it's already been sent.

3.7 Monitor & Control Tab

This tab has settings for viewing and customizing the Control Page as well as graphing the log file.

3.7.1 Monitor & Control Tab > CONTROL PAGE

This tab displays the current Control Page. The Control Page is what users will see after typing the IP address of the X-410 directly into the web browser address bar. The Control Page is highly configurable for your specific needs. The Control Page Setup tab determines what resources are shown on the Control Page and how they are presented and displayed.

An example of a Control Page with four 1-Wire temperature sensors:



An example of a Control Page with more of the basic X-410 resources:

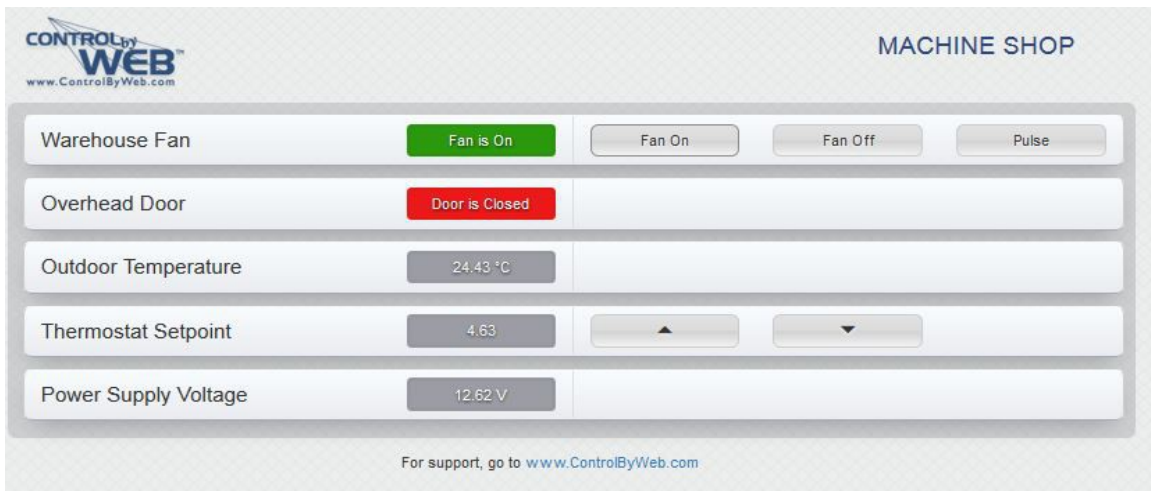

If a sensor is disconnected or fails, the data value will be shown as XX.

3.7.2 Monitor & Control Tab > CONTROL PAGE SETUP

The content, format and presentation of the Control Page is made by the settings on this tab. For example, the settings below illustrate a Control Page with a temperature sensor shown in the previous section.

After making changes, you must click the *Submit* button for the changes to take effect.

Note: Any browsers currently viewing the Control Page while making changes will need to be refreshed before seeing the new changes. Do this by clicking the Refresh button on your browser.

It is easy to explore and experiment with the “look and feel” of the Control Page. Make a change, submit the changes, refresh your browser - and see how it looks. The Control Page is what users will see and use.

CONTROL PAGE SETUP

CONFIGURE CONTROL PAGE

Header Text:

Show Header Logo: Yes No

Header Logo: 
 No file chosen

Footer Text/HTML:

Refresh Rate: Seconds

| | |
|--------------------------------------|---------------------------------------|
| Outdoor Temperature | <input type="button" value="Edit"/> |
| <input type="button" value="State"/> | <input type="button" value="Delete"/> |
| Indoor Temperature | <input type="button" value="Edit"/> |
| <input type="button" value="State"/> | <input type="button" value="Delete"/> |
| Indoor Humidity | <input type="button" value="Edit"/> |
| <input type="button" value="State"/> | <input type="button" value="Delete"/> |
| Freezer (thermocouple) | <input type="button" value="Edit"/> |
| <input type="button" value="State"/> | <input type="button" value="Delete"/> |

Header Text

The text entered here appears at the top of the *Control Page*. It also appears in the header of the email text when the email notification is used. This field can be up to 30 characters in length. The default text is X-410.

Show Header Logo

A graphic logo can be displayed in the upper left-hand corner of the Control Page. This setting determines if the logo is shown or not.

Header Logo

The *ControlByWeb* logo is shown by default. To upload a new logo, click *Choose New Logo*. A file upload dialog box opens allowing you to browse for the file on your computer. The file must be a *.png format. Click the  button to initiate the file upload. The logo file size must be less than 16 kb. Once a logo has been uploaded, the default ControlByWeb logo will be overwritten. The ControlByWeb logo will not be restored if the module is reset to factory defaults (there is only room for one logo.)

Footer Text/HTML

The bottom of the Control Page has a configurable “footer” field. The text entered in this setup box appears as a footer on the Control Page. The text can include HTML hypertext links as shown in the example.

Refresh Rate

The Control Page continually updates its contents by setting a timer in the web page that causes it to be reloaded at a specified time interval. The web page content will be refreshed at the time interval specified in this setting. It can be set from 1 to 60 seconds. The default Refresh Rate is 3 seconds.

Control Page Widgets

A list of I/O resources that can be added to the Control Page appear next. The “widgets” appear on the Control Page in the same order as the setup list. Resources such as local relays and digital inputs automatically appear in this list and can be removed from the Control Page, if desired. For all other I/O (counters, registers, 1-Wire sensors, timers, etc.), you must have previously added them in the I/O Setup tab before adding them to the Control Page.

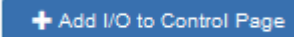
To add one or more widgets, click 

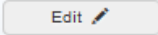
To edit a widget, click 

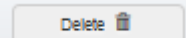
To remove a widget, click 

To re-arrange the order of the widgets, click the widget handle  and drag the widget to a different row.

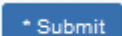
When finished, click  to save your edits.

To change the name of the resources (relays, digital inputs, 1-Wire sensors, registers and Vin) on the Control Page, edit the respective settings in the *I/O Setup Tab* and change the resource name. While

naming each resource, it is good practice to edit the associated status text. For example, for a digital input perhaps name the input “Warehouse Door”, set the *On Status Text* to “Door is Open” and the *Off Status Text* to “Door is Closed”.

Some widgets have more setup options than others. Widgets for Vin, 1-Wire sensors and timers can be added, but have no options to edit.

Once the I/O has been added, rearrange the I/O by clicking on the  icon and dragging to the desired position.

Click *Submit* once you have the finished making changes to the page.

Add I/O to the Control Page

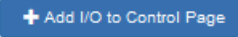
To add one or more widgets, click . From the list of available resources, check one or more *Add* boxes to add the selected resources.

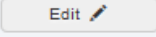
After adding the desired widgets to the Control Page, edit  the widgets one by one, as needed for the desired appearance and function. The visual presentation of the labels, buttons and colors can be highly configured. The display options available for the widgets depend on the specific resource. The next sections have a description of each widget editor.

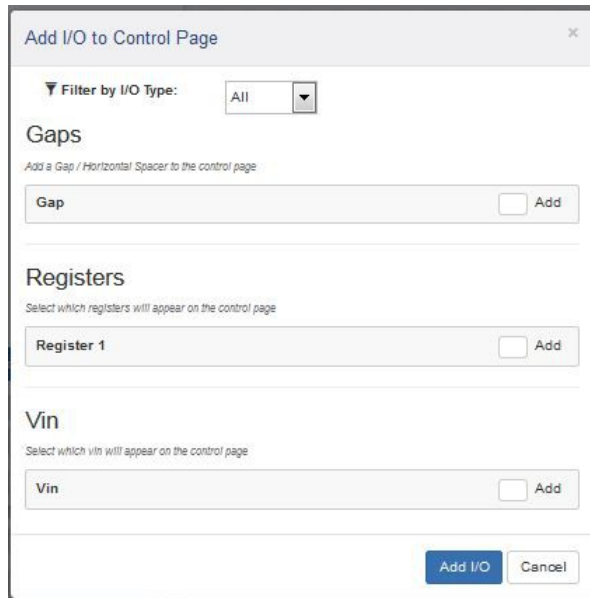

Gap Widgets

Gap widgets are cosmetic widgets that allow sections of the Control Page to be separated by a small space. This is useful when grouping similar controls together.

Relay Widget Editor

State

Show or Hide the relay state.

On Status Color

This setting specifies the color that will be displayed on the Control Page when the relay is On. Options are Red, Green, Yellow, Blue and White. The default color is **Green**.

Off Status Color

This setting specifies the color that will be displayed on the Control Page when the relay Off. Options are Red, Green, Yellow, Blue and White. The default color is **Red**.

ON Button

Show or Hide the On button.

ON Button Label

The text in this field specifies the text that will be displayed on the ON Button on the Control Page to turn on the relay. Up to 16 characters may be entered in this field. The default text is "On".

Off Button

Show or Hide the Off button.

OFF Button Label

The text in this field specifies the text that will be displayed on the OFF Button in the Control Page to turn off the relay. Up to 16 characters may be entered in this field. The default text is "Off".

Toggle Button

Show or Hide the Toggle button.

Toggle Button Label

The text entered in this field appears in the 'Toggle' button. Up to 16 characters may be entered in this field. The default text is "Toggle".

Pulse Button

Show or Hide the Pulse button.

Pulse Button Label

The text entered in this field appears in the 'Pulse' button. Up to 16 characters may be entered in this field. The default text is "Pulse".

Digital Input Widget Editor

State

Show or Hide the state (value).

On Status Color

This setting specifies the color that will be displayed on the Control Page when the input is considered On. Options are Red, Green, Yellow, Blue and White. The default color is **Green**.

Off Status Color

This setting specifies the color that will be displayed on the Control Page when the input is considered Off. Options are Red, Green, Yellow, Blue and White. The default color is **Red**.

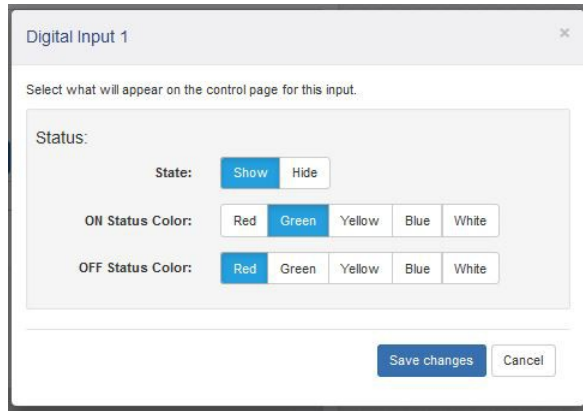

Input Counter Widget Editor

Count/Frequency

Show or Hide the counter/frequency value.

Allow reset in control page

When enabled, the count value on the Control Page may be clicked to reset the counter's value back to 0 after confirmation.

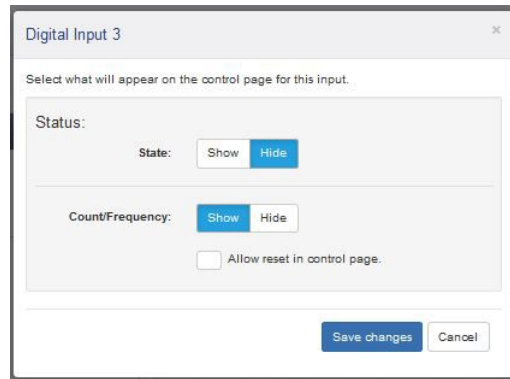

Register Widget Editor

Registers can be changed externally through the Control Page, XML requests, ModBus, or the BASIC script. This allows a BASIC script to react to user input. These variables are considered to be floating point numbers, just like other variables in the BASIC script.

Status:

State

Show or Hide the state (value).

Control Buttons:

There are four different types of control buttons for a register widget, each types has its own set of options:

1. Type = Increment/Decrement

Increment Button

Show or hide the button

Decrement Button

Show or hide the button

Step

This setting is the amount the Register will be incremented or decremented when the respective increment/decrement button is clicked. The value can be an integer or floating point number.

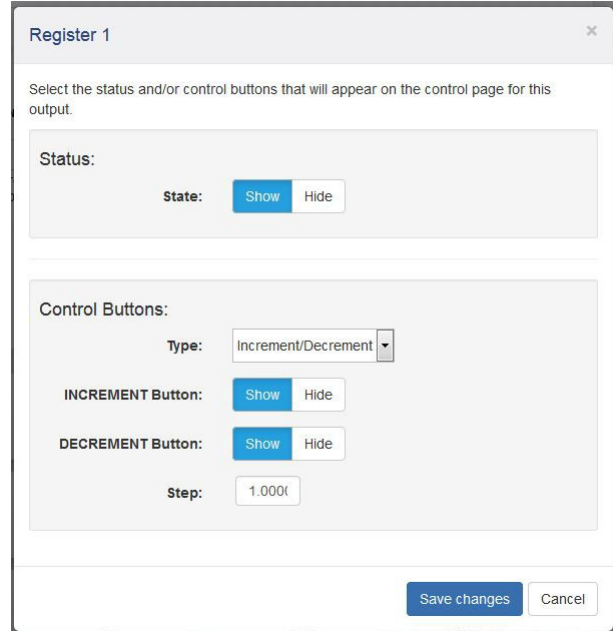

2. Type = Custom Buttons

This setting provides up to 4-buttons with custom labels and set-values. Use one or more of these buttons to force a Register to specified fixed values.

Use these buttons for example, to provide a fan speed control with buttons labeled *High*, *Medium* and *Low* and perhaps with 100%, 50% and 20% for the button set-values.

Button (1-4)

Show or Hide the button.

Label (1-4)

The text in this field specifies the text that will be displayed in the button. Up to 16 characters may be entered in this field.

Value (1-4)

When the user clicks the button, the Register defined in the Widget being edited will be set (forced) to the specified fixed value. The setting can be any integer or floating point value.

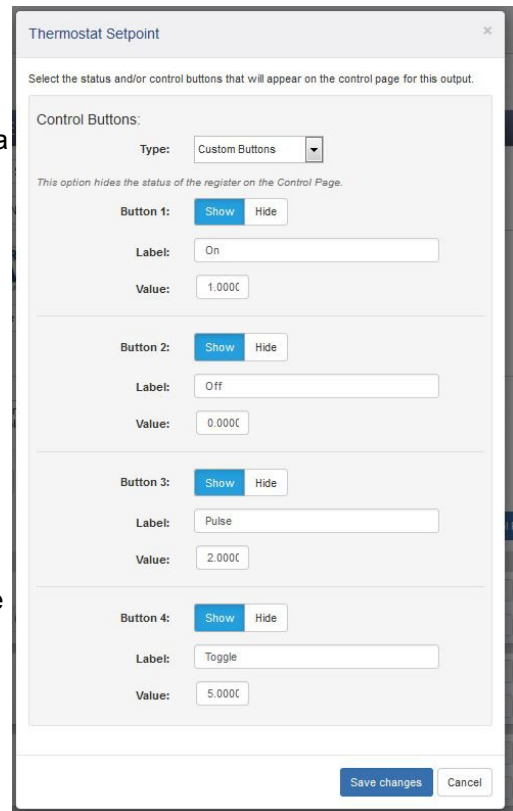

3. Control Button Type = Text Box

Use this setting to allow the user to manually change the value of a Register. The input can be an integer or floating point value. The input value can be restricted between minimum and maximum values defined by settings for the Register itself. See *Section I/O Setup Tab > REGISTERS*.

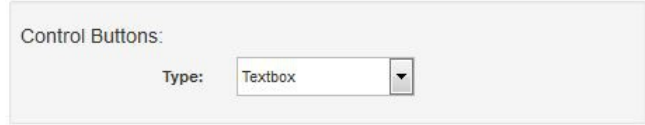

Use this input field for example, to enter a thermostat set-point value.

4. Analog I/O Status Colors

The status colors of analog I/O can be changed by creating Tasks under Control/Logic which set the I/O status colors.

3.7.3 Monitor & Control Tab > GRAPH LOG FILE

The data in the log file can be displayed in a graphical format. Use the fields in this tab to control and view the graph. With the *Start* and *End* settings you can “zoom in” to display the data over a specific time interval.

3.7.3.1 Settings

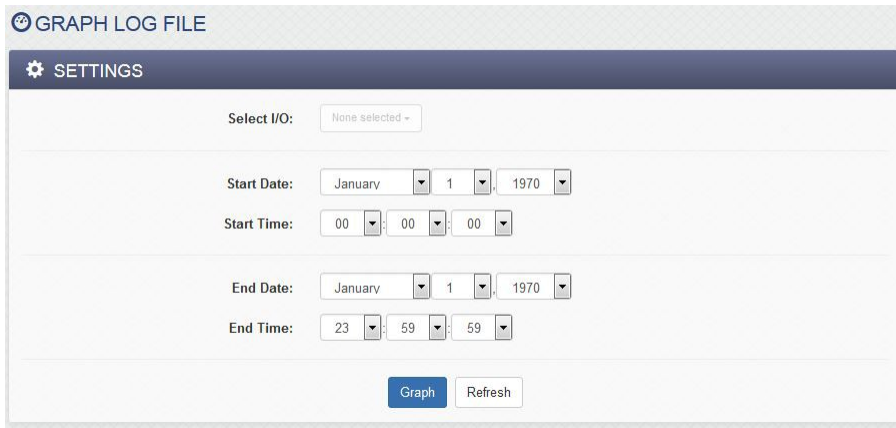

Select I/O

Select which I/O from the log file is to be graphed. Up to 10 I/O can be graphed at a time.

Start Date & Time

This is the start time for the log file graph. Select the month, day, year and time of day using the drop-down boxes.

End Date & Time

This is the stop time for the log file graph. Select the month, day, year and time of day using the drop-down boxes.

3.7.3.2 Settings

The graph includes a legend describing the colors and I/O in the top right corner of the graph. The graph is interactive in that if you hover over specific data-points, the exact values can be read. To zoom in on a specific region of the graph, click and drag to highlight the area of interest. To return to a normal zoom, click the Graph button.

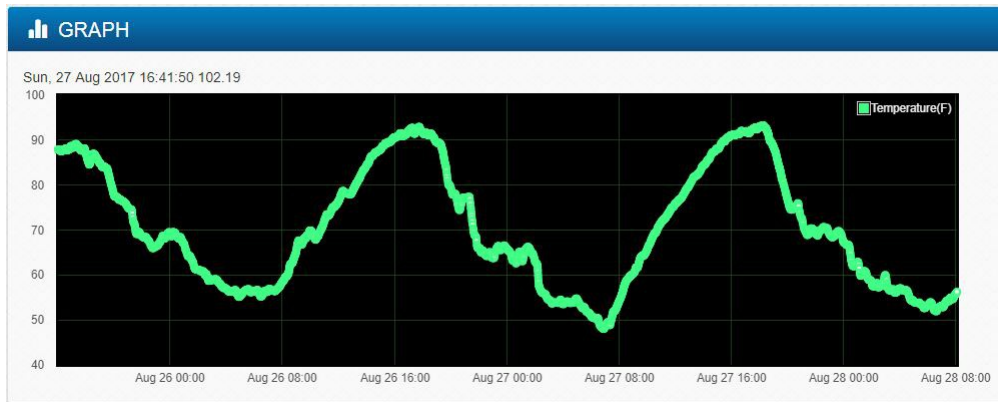

Section 4: Control Page

The X-410 can be operated using a web browser, by sending HTTP requests from a custom application, by sending Modbus/TCP requests and/or SNMP requests. The X-410 relays (and remote relays) can be controlled from the Control Page if the page has a widget for the specific I/O.

Administrators, Managers and Users have separate access privilege to the Control Page. See General Settings Tab > PASSWORDS for a description of each access privilege.

4.1 Browser Operation

There are two ways users can access the Control Page by using a web browser:

1. Control Page

The first is by typing the IP address of the X-410 directly into the web browser address bar. For example, using the default IP address, the user would enter <http://192.168.1.2> (If the IP address was changed from the default, the user must use the new IP address.)

Note that if any port is used other than the default port 80, the port must also be included in the request. For example, accessing the unit at port 8000 would be as follows: <http://192.168.1.2:8000>

To access the X-410 over HTTPS, the user would enter: <https://192.168.1.2>

If any port is used other than the default HTTPS port 443, the port must also be included in the request. Additionally, you will get a warning when accessing the X-410 over HTTPS, this is because the X-410 is using a default, self-signed SSL certificate.

The I/O on the Control Page updates every 3 seconds.

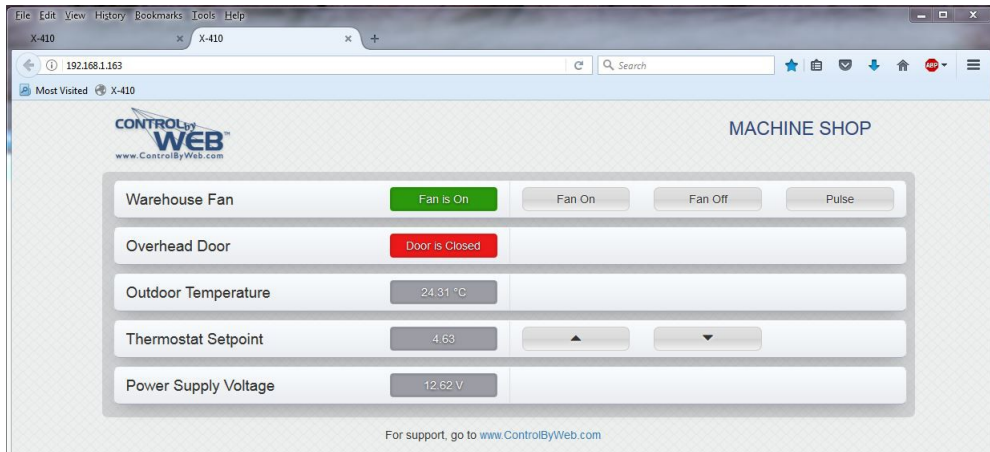

The Control Page is normally what users see and use and it can be highly configured to fit your needs. The Monitor & Control Tab > CONTROL PAGE SETUP tab has settings that determine what resources are displayed and how they are formatted.

2. Control Page via Setup Tabs

The second method of accessing the Control Page is through the Setup pages (<http://192.168.1.2/setup.html>). Choose Monitor & Control Tab > CONTROL PAGE.

This displays the same Control Page as before, but has the setup menu on the left side.

Section 5: Example Control Scenarios

This section presents various control examples using *Scheduled Tasks*, *Conditional Tasks*, and BASIC scripts to solve example applications.

5.1 Control Logic Examples Using Tasks/Functions

The following examples illustrate tasks or functions that can be performed by the X-410. These examples may be used as a tutorial to illustrate how to perform certain functions and can be a good starting point for more advanced logic.

Important: When creating tasks that perform actions when something is triggered, the action will not automatically reverse when the trigger goes away. For example, if a trigger turns a relay on when temperature rises above 50 degrees, you must create a second task to turn the relay off when the temperature falls below 50 degrees.

5.1.1 Temperature Alarm ON (or OFF) Only

This is an example of an over-temperature safety control for an incubator.

The relay is to be turned on manually and has a widget on the Control Page with on/off buttons.

If the *Chamber Temperature* (a 1-Wire temperature sensor) is greater than the set point, Relay2 is turned off to disable the heater.

Conditional Task 1

- Condition 1: When temperature rises above 50 degrees C.
- Action 1: Turn off Relay 2 (*Note: Relay 2 will not automatically turn on when temperature falls below 50. To automatically control the relay, see the example below.*)

5.1.2 Temperature Alarm ON & OFF

Conditional Task 1

- Condition 1: When the temperature rises above 50 degrees F
- Action 1: Turn Relay 1 on

Conditional Task 2

- Condition 1: When the temperature falls below 49 degrees F.
- Action 1: Turn off Relay 1

Note that using 50 for one trigger and 49 for the other trigger provides a 1 degree deadband without using the built-in deadband function. This requires two tasks: One task to turn the relay on and a second task to turn the relay off.

The image shows two side-by-side 'Add Conditional Task' dialog boxes. The left dialog is titled 'High Alarm' and the right is titled 'Clear High Alarm'. Both dialogs have a 'Task Name' field at the top. Below that is an 'If:' section with a 'TRIGGER' sub-section. In the 'High Alarm' dialog, Condition 1 is 'Temp' with a value of '50' and a greater-than-or-equal-to operator. In the 'Clear High Alarm' dialog, Condition 1 is 'Temp' with a value of '49' and a less-than operator. Both have a 'Deadband' of '0.0'. Below the 'If:' section is a 'During:' section with 'Always' selected. The 'Then:' section has an 'ACTIONS' sub-section. In the 'High Alarm' dialog, Set Action 1 is 'Relay 2' and Set To is 'On'. In the 'Clear High Alarm' dialog, Set Action 1 is 'Relay 2' and Set To is 'Off'. Both dialogs have 'Add' and 'Cancel' buttons at the bottom.

5.1.3 Send an email if the temperature is less than 33°C between 9:30PM and 10PM each day

In this example the Deadband of 1 degree was used to prevent multiple email messages being sent due to "chatter".

Another email message won't be sent until the temperature rises above 34 degrees (33 plus 1 degree deadband) and then back below 33 degrees.

The "During" section of the task limits the time when the triggers are effective.

Add Conditional Task

Task Name:

If:

TRIGGER
Triggers ONLY occur when conditions change to true. The logic operations are event driven, and are not combinational. Conditions must change to false and back to true to re-trigger.

Condition 1:
Value:
Deadband:

Condition 2:

During:

Start Time:(HH:MM:SS) : :

End Time:(HH:MM:SS) : :

Day(s) of Week:

Then:

ACTIONS
Actions only occur at the moment the trigger status changes.

Set Action 1:
Send Email To:

Set Action 2:

Set Action 3:

5.1.4 Log a counter value at midnight and reset the counter to 0 to begin the next day.

A counter is configured in the *I/O Setup* tab to count the number of cars which activate a road-tube sensor. Use this task to log the number of cars passing each day.

At 00:00:00 the daily task initiates two actions.

Action1 makes the data log.

Action2 resets the counter to 0 to begin the next day.

Add Scheduled Task [X]

Task Name:

Start Date: ,

Start Time:

: :

Run Mode:

Condition:

Set Action 1:

Set Action 2:

Options:

Set Action 3:

Set Repeat:

Repeat Every: Day(s)

End Repeat:

5.1.5 Send a delayed email/text message (or delay enabling relay).

The X-410 can be configured to send an email message (or turn on a relay) immediately when an input turn on. In some cases it is useful to delay the action (send email or turn on relay) so that it doesn't happen immediately.

For example, if a sensor is attached to a freezer door that causes input 1 to turn on when the door is opened, the following configuration will cause the X-410 to send out an email message if the freezer door is left open for 30 seconds or longer. If the freezer door is closed before the 30 second timer expires no email message will be sent.

In this example, Input 1 has been renamed as "Freezer Door". Input 1 "ON" has been renamed as "Open". Input 1 "OFF" has been renamed as "Closed". A timer has been set up called "Door Timer".

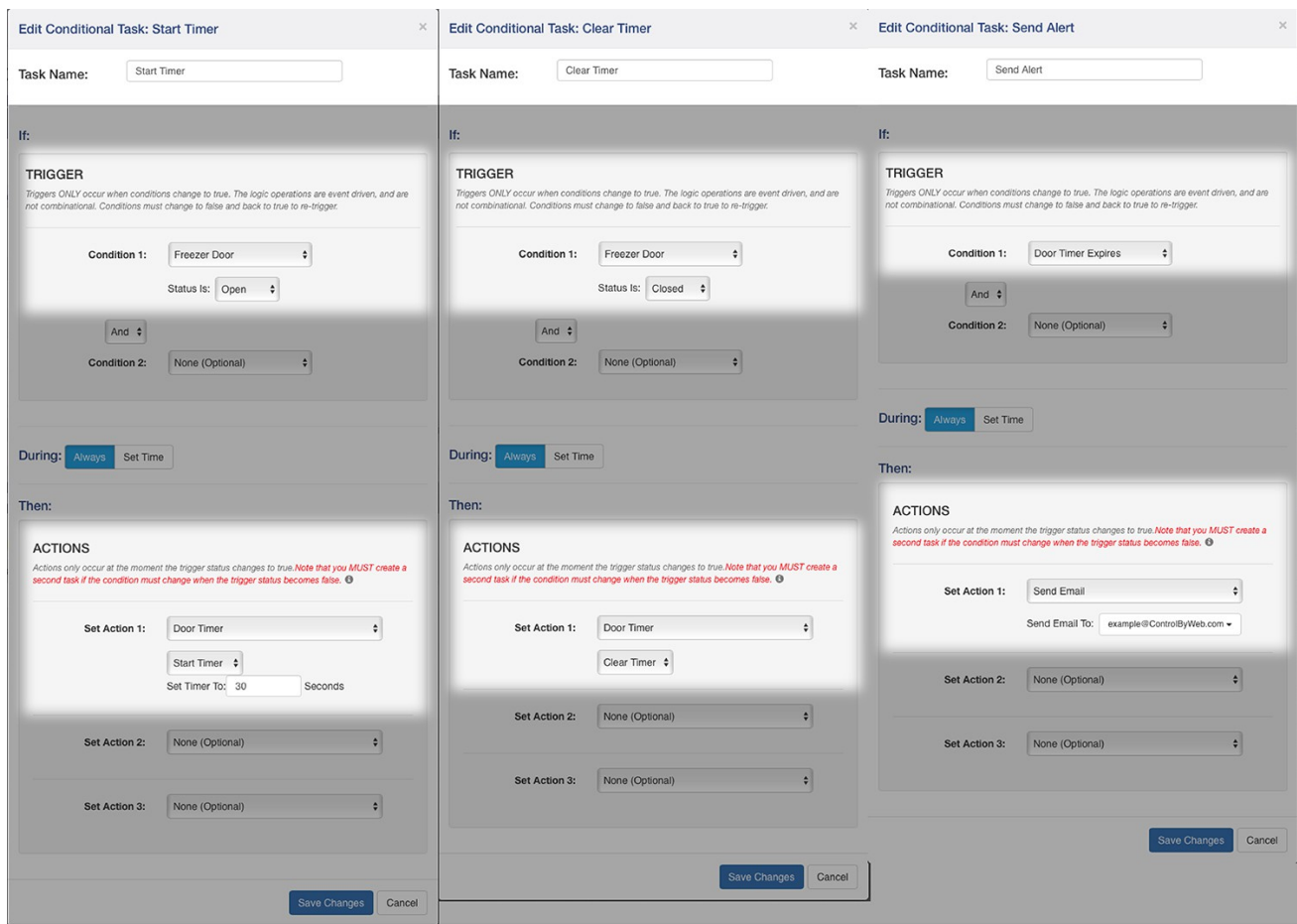

5.1.6 Only allow one relay to be on at at time

This example shows how to configure the relays to be exclusive. When one relay turns on it will turn off all other local relays.

To do this. Go to the *I/O Setup* tab and select *Relays*. Click *Edit* on a local relay and next to the *Make Exclusive* option, select *Yes*. Repeat this for all four local relays.

When you enable *Make Exclusive* for a relay, each time that relay is turned on, it will cause all other local relays to turn off. If you turn on relay that has *Make Exclusive* enabled and then turn on another relay that does not have *Make Exclusive* enabled you will have two relays turned on at the same time.

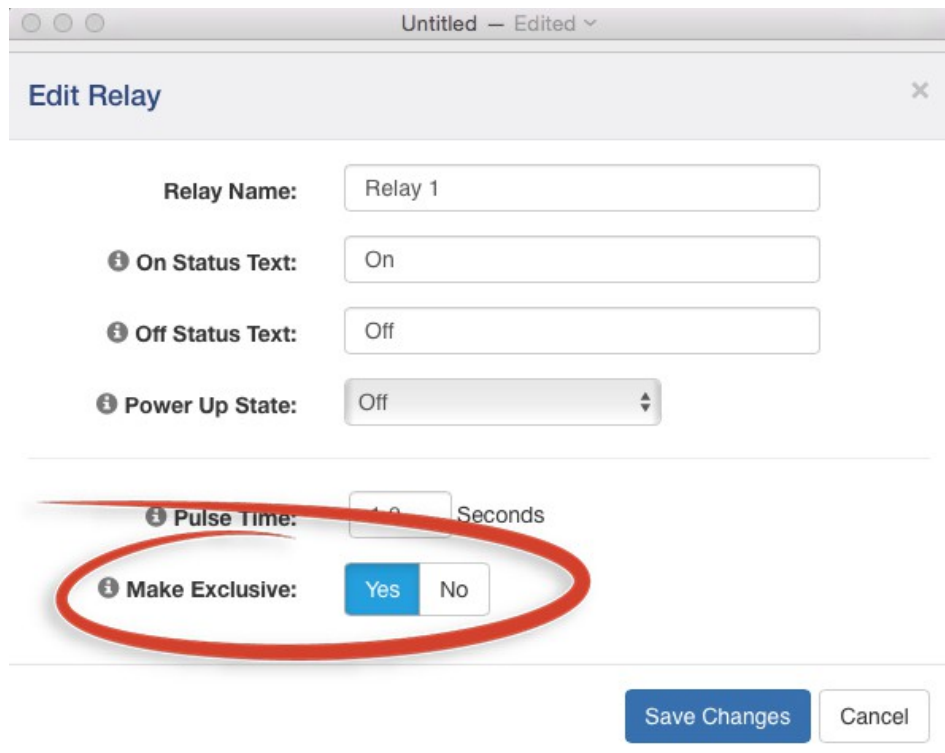

5.1.7 When Input 1 goes on, pulse Relay 1 five times and then stop

This example uses two Conditional Tasks as shown below.

Note: A Register and a Timer must already be set up under the I/O Setup tab.

The screenshot shows the X410 web interface for 'CONTROL/LOGIC SETUP'. The page title is 'X410 Programmable Web-Enabled I/O Controller'. The current date and time are 'WED, 27 SEP 2017 11:32:07' and the status is 'CURRENTLY RUNNING NORMAL SCHEDULE'. The left sidebar contains navigation options: General Settings, Remote Devices, I/O Setup, Control/Logic, Tasks/Functions, Basic Script, Logging, and Monitor & Control. The main content area is divided into several sections:

- TASKS/FUNCTIONS**: Includes a 'SCHEDULED' table with columns: Name, Start Date/Time, Repeat, Actions, Next Occurance, Run Mode, and Edit. An 'Add Scheduled Task +' button is present.
- CONDITIONAL**: Includes a table with columns: Name, Trigger, Actions, and Edit. Two tasks are listed:
 - Trigger relay**: Trigger is 'If Digital Input 1 is On'. Actions are 'Pulse Relay 1 On For 1.0 sec.', 'Set Register 1 To 4', and 'Start Timer 1 for 2 sec.'.
 - Restart relay**: Trigger is 'If Timer 1 expires. and Register 1 > 0'. Actions are 'Pulse Relay 1 On For 1.0 sec.', 'Decrement Register 1 By 1', and 'Start Timer 1 for 2 sec.'.
- AUTOMATIC REBOOT**: Includes a table with columns: Name, Ping, Action(s), Status, and Edit. An 'Add Auto Reboot Task +' button is present.
- OVERRIDE SCHEDULES**: Includes an 'OVERRIDE SCHEDULE' table with columns: Name, Start Date/Time, End Date/Time, Repeat, and Edit. An 'Add Override Schedule +' button is present.

5.1.8 Send Email if Input stops toggling

Monitor Input 1 for state changes. If Input 1 doesn't change state every 5 seconds or faster an email message will be sent.

Here there are two tasks. Task 1 starts (or re-starts) a timer each time the input changes. Task 2 sends the alert if the timer ever expires.

The image shows two side-by-side configuration windows for conditional tasks. The left window is titled "Edit Conditional Task: Input 1 Monitor" and the right window is titled "Edit Conditional Task: Send Alert".

Left Window: Edit Conditional Task: Input 1 Monitor

- Task Name:** Input 1 Monitor
- If:**
 - TRIGGER**
Triggers ONLY occur when conditions change to true. The logic operations are event driven, and are not combinational. Conditions must change to false and back to true to re-trigger.
 - Condition 1:** Digital Input 1 (dropdown), Status Is: Changes (dropdown)
 - And** (dropdown)
 - Condition 2:** None (Optional) (dropdown)
- During:** Always (selected), Set Time
- Then:**
 - ACTIONS**
Actions only occur at the moment the trigger status changes to true. Note that you MUST create a second task if the condition must change when the trigger status becomes false.
 - Set Action 1:** Timer 1 (dropdown), Start Timer (dropdown), Set Timer To: 5 Seconds
 - Set Action 2:** None (Optional) (dropdown)
 - Set Action 3:** None (Optional) (dropdown)

Right Window: Edit Conditional Task: Send Alert

- Task Name:** Send Alert
- If:**
 - TRIGGER**
Triggers ONLY occur when conditions change to true. The logic operations are event driven, and are not combinational. Conditions must change to false and back to true to re-trigger.
 - Condition 1:** Timer 1 Expires (dropdown)
 - And** (dropdown)
 - Condition 2:** None (Optional) (dropdown)
- During:** Always (selected), Set Time
- Then:**
 - ACTIONS**
Actions only occur at the moment the trigger status changes to true. Note that you MUST create a second task if the condition must change when the trigger status becomes false.
 - Set Action 1:** Send Email (dropdown), Send Email To: example@ControlByWeb.com (text input)
 - Set Action 2:** None (Optional) (dropdown)
 - Set Action 3:** None (Optional) (dropdown)

Both windows have "Save Changes" and "Cancel" buttons at the bottom.

5.1.9 If input 1 is on, continually turn relay on and off at a rate of 1 change per second.

This example uses three tasks:

Conditional Task 1: When Input 1 goes on it starts a 2 second timer and pulses Relay 1 for 1 second.

Conditional Task 2: When the 2 second timer expires it pulses Relay 1 for 1 second and restarts the timer.

Conditional Task 3: When input 1 goes off it stops the timer and turns off the relay.

The screenshot shows the X410 web interface for 'CONTROL/LOGIC SETUP'. The page title is 'X410 Programmable Web-Enabled I/O Controller'. The current date and time are 'TUE, 03 OCT 2017 13:22:58' and the status is 'CURRENTLY RUNNING NORMAL SCHEDULE'. The interface is divided into several sections:

- SCHEDULED:** A table with columns: Name, Start Date/Time, Repeat, Actions, Next Occurance, Run Mode, Edit. An 'Add Scheduled Task +' button is present.
- CONDITIONAL:** A table with columns: Name, Trigger, Actions, Edit. It contains three tasks:

| Name | Trigger | Actions | Edit |
|------------------|---------------------------|---|--------|
| Input 1 On | If Digital Input 1 is ON | Pulse Relay 1 On For 1.0 Sec. Start Timer 1 For 2 Sec. | Edit X |
| Continue Pulsing | If Timer 1 Expires | Pulse Relay 1 On For 1.0 Sec. Start Timer 1 For 2 Sec. | Edit X |
| Input 1 Off | If Digital Input 1 is OFF | Set Relay 1 To Off Clear Timer 1 | Edit X |

 An 'Add Conditional Task +' button is also present.
- AUTOMATIC REBOOT:** A table with columns: Name, Ping, Action(s), Status, Edit. An 'Add Auto Reboot Task +' button is present.
- OVERWRITE SCHEDULES:** A table with columns: Name, Start Date/Time, End Date/Time, Repeat, Edit. An 'Add Override Schedule +' button is present.

5.1.10 Turn on relay when Input 1 AND Input 2 is on. Turn off when either go off.

This example requires two Conditional Tasks. One task to turn the relay on, and the other to turn the relay off.

The screenshot shows the X410 web interface for 'CONTROL/LOGIC SETUP'. The top right corner displays the date and time: 'TUE, 03 OCT 2017 13:28:39' and 'CURRENTLY RUNNING NORMAL SCHEDULE'. The left sidebar contains navigation options: General Settings, Remote Devices, I/O Setup, Control/Logic, Tasks/Functions, Basic Script, Logging, and Monitor & Control. The main content area is divided into several sections:

- TASKS/FUNCTIONS**: Includes a 'SCHEDULED' table with columns for Name, Start Date/Time, Repeat, Actions, Next Occurance, Run Mode, and Edit. There is an 'Add Scheduled Task +' button.
- CONDITIONAL**: Includes a table with columns for Name, Trigger, Actions, and Edit. There is an 'Add Conditional Task +' button. Two tasks are listed:

| Name | Trigger | Actions | Edit |
|----------------|---|--------------------|--------|
| Turn ON Relay | If Digital Input 1 is On and Digital Input 2 is On | Set Relay 1 To On | Edit X |
| Turn OFF Relay | If Digital Input 1 is Off or Digital Input 2 is Off | Set Relay 1 To Off | Edit X |
- AUTOMATIC REBOOT**: Includes a table with columns for Name, Ping, Action(s), Status, and Edit. There is an 'Add Auto Reboot Task +' button.
- OVERVERRIDE SCHEDULES**: Includes an 'OVERVERRIDE SCHEDULE' table with columns for Name, Start Date/Time, End Date/Time, Repeat, and Edit. There is an 'Add Override Schedule +' button.

5.1.11 Turn on Relay 3 when X-410 supply voltage falls below 11V.

This example uses two Conditional Tasks. One to turn the relay on when the supply voltage drops, and another to turn the relay off when the supply voltage goes back up.

The image displays two side-by-side screenshots of the 'Edit Conditional Task' configuration interface. The left window is titled 'Edit Conditional Task: Battery Voltage Alarm' and the right is 'Edit Conditional Task: Battery Voltage OK'. Both windows show the configuration for a conditional task, divided into 'If' (TRIGGER) and 'Then' (ACTIONS) sections.

Left Window: Edit Conditional Task: Battery Voltage Alarm

- Task Name:** Battery Voltage Alarm
- If:**
 - TRIGGER:** Triggers ONLY occur when conditions change to true. The logic operations are event driven, and are not combinational. Conditions must change to false and back to true to re-trigger.
 - Condition 1:** Vin (dropdown), Value: < (dropdown), 11.00 (input), V (unit), Deadband: 0.00 (input), V (unit).
 - And:** (dropdown)
 - Condition 2:** None (Optional) (dropdown)
- During:** Always (selected), Set Time (button)
- Then:**
 - ACTIONS:** Actions only occur at the moment the trigger status changes to true. Note that you MUST create a second task if the condition must change when the trigger status becomes false.
 - Set Action 1:** Relay 3 (dropdown), Set To: On (dropdown)
 - Set Action 2:** None (Optional) (dropdown)
 - Set Action 3:** None (Optional) (dropdown)
- Buttons:** Save Changes, Cancel

Right Window: Edit Conditional Task: Battery Voltage OK

- Task Name:** Battery Voltage OK
- If:**
 - TRIGGER:** Triggers ONLY occur when conditions change to true. The logic operations are event driven, and are not combinational. Conditions must change to false and back to true to re-trigger.
 - Condition 1:** Vin (dropdown), Value: ≥ (dropdown), 11.50 (input), V (unit), Deadband: 0.00 (input), V (unit).
 - And:** (dropdown)
 - Condition 2:** None (Optional) (dropdown)
- During:** Always (selected), Set Time (button)
- Then:**
 - ACTIONS:** Actions only occur at the moment the trigger status changes to true. Note that you MUST create a second task if the condition must change when the trigger status becomes false.
 - Set Action 1:** Relay 3 (dropdown), Set To: Off (dropdown)
 - Set Action 2:** None (Optional) (dropdown)
 - Set Action 3:** None (Optional) (dropdown)
- Buttons:** Save Changes, Cancel

5.1.12 Scheduled Relay Control with Manual Override

Configure Input 1 to control Relay 1. Schedule Relay 1 to turn on at 10:00PM every week day and back off at 6:00AM the next day. If input 1 changes then change the state of the relay no matter what the schedule indicates.

First, set a Conditional Task so that if Digital Input 1 Changes then Toggle Relay 1.

Second, set a scheduled task to turn Relay 1 on every weekday at 10:00PM (set to weekly and select weekdays).

Third, set a scheduled task to turn Relay 1 off every Tuesday though Saturday (set to weekly and specify days).

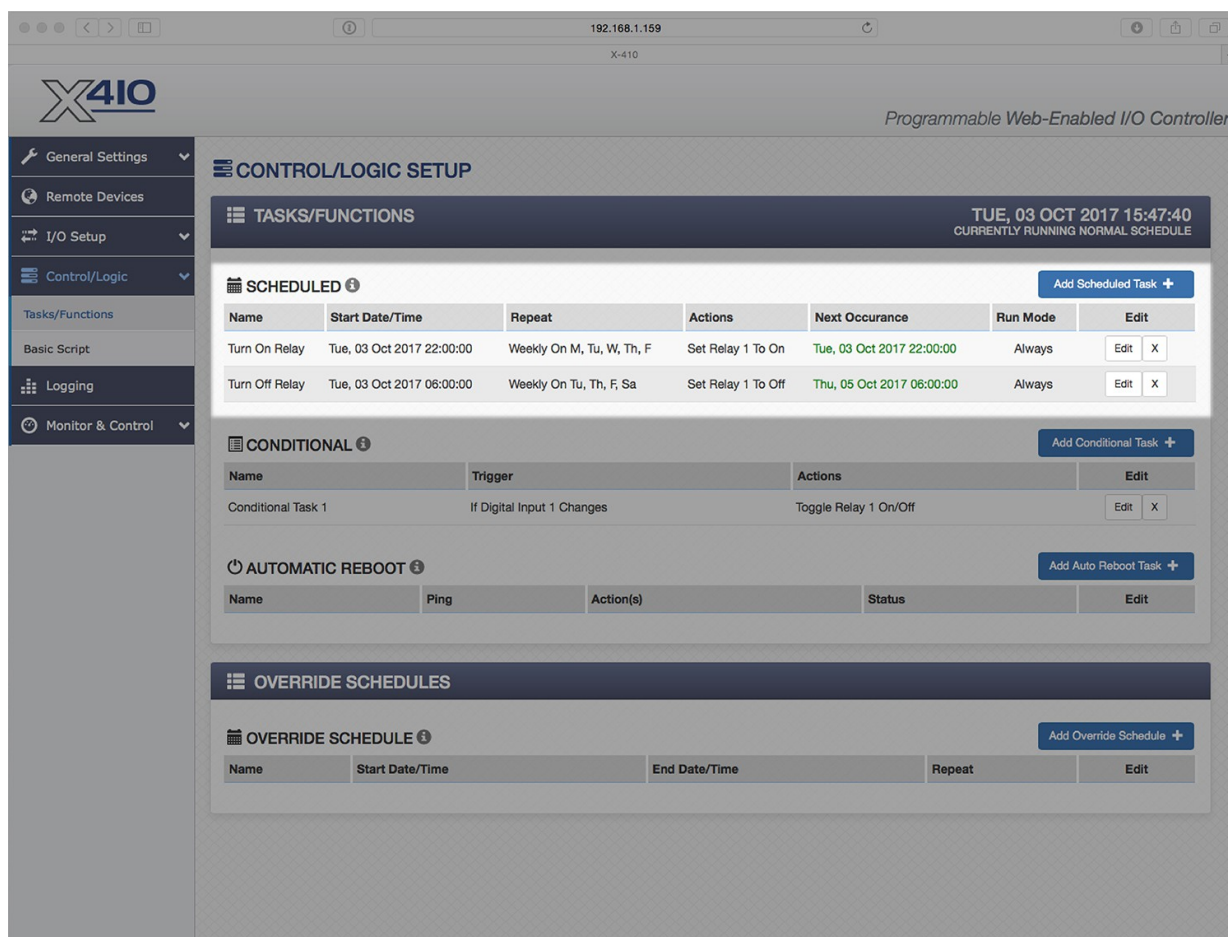

5.1.13 Send an email message every 24 hours

Add Scheduled Task ✕

Task Name:

Run Mode:

Start Date:

Start Time:

: :

Condition:

Set Action 1:

Send Email To:

Set Action 2:

Set Action 3:

Set Repeat:

Repeat Every: Day(s)

End Repeat:

5.1.14 Turn Relay 1 off after 5 seconds no matter how it got turned on

This requires two Conditional Tasks:

The screenshot shows the X410 web interface for 'CONTROL/LOGIC SETUP'. The page title is 'X410 Programmable Web-Enabled I/O Controller'. The current date and time are 'TUE, 03 OCT 2017 15:56:42' and the status is 'CURRENTLY RUNNING NORMAL SCHEDULE'. The left sidebar contains navigation options: General Settings, Remote Devices, I/O Setup, Control/Logic, Tasks/Functions, Basic Script, Logging, and Monitor & Control. The main content area is divided into three sections:

- SCHEDULED**: A table with columns: Name, Start Date/Time, Repeat, Actions, Next Occurance, Run Mode, and Edit. There is an 'Add Scheduled Task +' button.
- CONDITIONAL**: A table with columns: Name, Trigger, Actions, and Edit. There is an 'Add Conditional Task +' button. Two tasks are listed:

| Name | Trigger | Actions | Edit |
|--------------------------|--------------------|--------------------------|--------|
| Strt Timer when Relay On | If Relay 1 is On | Start Timer 1 For 5 Sec. | Edit X |
| Turn Off Relay | If Timer 1 Expires | Set Relay 1 To Off | Edit X |
- AUTOMATIC REBOOT**: A table with columns: Name, Ping, Action(s), Status, and Edit. There is an 'Add Auto Reboot Task +' button.
- OVERRIDE SCHEDULES**: A table with columns: Name, Start Date/Time, End Date/Time, Repeat, and Edit. There is an 'Add Override Schedule +' button.

At the bottom of the page, there is copyright information: 'Copyright Information', 'For product support, go to www.ControlByWeb.com', and 'Xytronix Research & Design, Inc.'.

5.1.15 Require Input to stay on for 5 seconds before triggering

This can be done in the digital input setup. By default the digital inputs must stay "on" for 20mS which is used to de-bounce the digital inputs. This can be changed to other values by accessing the digital input setup pages (I/O Setup -> Digital Inputs -> Edit). Under the setup pages there is an option for "Advanced Features". Change the Hold Time to your desired delay time (in milliseconds).

The screenshot shows a dialog box titled "Edit Digital Input" with a close button (X) in the top right corner. The dialog contains several input fields and a dropdown menu:

- Digital Input Name:** A text input field containing "Digital Input 1".
- On Status Text:** A text input field containing "On".
- Off Status Text:** A text input field containing "Off".
- Mode:** A dropdown menu currently set to "ON/OFF".
- Advanced Features:** A section header with a gear icon, which is expanded to show additional options.
- Hold Time (De-Bounce):** A text input field containing "5000" followed by "ms". This field is circled in red.
- Measure On Time:** A checkbox labeled "Enable" which is currently unchecked.
- Measure Total On Time:** A checkbox labeled "Enable" which is currently unchecked.

At the bottom right of the dialog, there are two buttons: "Save Changes" (a blue button) and "Cancel" (a white button with a grey border).

5.1.16 Network Monitor between two X-410 Devices (Advanced)

In this example we will configure two X-410 devices to share a register. In the example we are using this as a network monitor, but this example illustrates how to share register or I/O states between modules.

One X-410 (we will call X-410_ONE) will be configured to share a register with a second X-410 (we will call X-410_TWO). X-410_ONE will change that register value once every 10 seconds. X-410_TWO will monitor that register value. If X-410_TWO detects no changes to the register for more than 12 seconds it will send an email alert.

Setup X-410_ONE communications with X-410_TWO:

1. Connect both devices to the network and assign IP address to each of them.
2. Open the setup page for X-410_ONE and select "Remote Devices" tab. Click the "Find Devices" button. The other X-410 (X-410_TWO) should appear in the list. If multiple X-410 units are installed on the network you may need to identify it by serial number. Select that X-410 device so the "Add Remote Device" window appears. Within that window...
 - Name the device "X-410_TWO"
 - Select Model X-410 (should already be selected)
 - Serial number should be filled in with correct serial number.
 - IP address should have correct IP address for X-410_TWO and port should be correct.
 - Set up the security options and enter passwords for X-410_TWO
 - In the bottom portion of the window, select "Instant Send"
 - Click "Add Device"

Wait a minute and then you should see X-410_TWO in the Remote Device List and the status should indicate a response time (in milliseconds) from the remote unit (the smaller the response time the better).

Now X-410_ONE is set up to push its I/O state to the remote device. By default it will push the state every 3 seconds (PUSH interval) but we want it to push its state instantly when the register changes so we will set that up in Conditional Tasks.

Setup of X-410_ONE to toggle register and share it with X-410_TWO (add two Conditional Tasks):

1. Open setup page for X-410_ONE (should already be there from above setup)
2. Set up a timer (called Timer 1) with a Power Up value of 8 seconds. This timer will be used to change the register and the Power Up value will cause it to start automatically.
3. Set up a task and call it "Toggle Register to 1". Set the trigger to "Timer 1 Expires AND Register 1 = 0". Set the Actions to "Set Register 1 to 1" and "Start Timer 1 for 10 Seconds" and "Push I/O State To Remote Receiver Device"
4. Set up a task and call it "Toggle Register to 0". Set the trigger to "Timer 1 Expires AND Register 1 = 1". Set the Actions to "Set Register 1 to 0" and "Start Timer 1 for 10 Seconds" and "Push I/O State To Remote Receiver Device"

Setup of X-410_TWO to monitor the register from X-410_ONE and sent alert if the register doesn't change within 12 seconds:

1. Open setup page for X-410_TWO and select Remote Devices tab. You should see X-410_ONE in the list of devices but the name will show as the serial number rather than the name X-

410_ONE. You can click edit and change the name to X-410_ONE. If the X-410_ONE device doesn't appear in the list you will need to add it to the list manually.

2. Once the X-410_ONE device appears as one of the Remote Devices you will need to add its register to the local I/O. Click on I/O Setup, then Registers. At the bottom of the table, click on the button called "Add Remote Register". Add the register "X-410_ONE Register 1" to the list. You should now see this new register listed under "Remote Register".
3. We need a timer to go to I/O Setup and create a timer called "Timer 1". Give it a power up value of 30 seconds to make sure both X-410 units have plenty of time to boot before sending error messages.
4. Now add the logic. Click on "Control/Logic" and create a new Conditional Task. Call this task "Set Timer When 1". Set trigger Condition 1 to "X-410_ONE Register 1 = 1". Set Action 1 to "Start Timer" with a time of 12 Seconds.
5. Add a second Conditional Task. Call this task "Set Timer When 0". Set trigger Condition 1 to "X-410_ONE Register 1 = 0". Set Action 1 to "Start Timer" with a timer of 12 Seconds.
6. Add a third Conditional Task. Call this task "Send Alarm". Set trigger Condition 1 to "Timer 1 Expires". Set Action 1 to "Send Email" and specify the email address where the message should go (if no email addresses appear you will need to set them up first).

For diagnostic purposes, you can configure a relay to click every time the register gets updated. This way you will hear a click every 10 seconds when the register on the remote relay changes. To do this, add one more action (Action 2) to X-410_TWO on steps 4 and 5 above (Relay 4, Pulse On for 0.1 seconds).

5.2 Control logic examples using BASIC Scripts

Most advanced logic can be accomplished using the X-410's Task Builder; however, the X-410 has a BASIC interpreter that can also be used for advanced logic.

With the X-410, the I/O resources are not fixed. After 1-Wire sensors, registers and other I/O are added, they can be controlled and monitored within BASIC scripts. BASIC scripts must reference I/O resources such as digital inputs and relays in the form of io.name where "name" is the resource name defined when the resource was added in the I/O Setup Tab.

If the resource name has embedded spaces, they must be removed in the io.name statement. The first character must be lower case. For example, if a relay is named "Warehouse Fan", the fan can be turned on with the BASIC statement "LET io.warehouseFan = 1". If a resource name is changed during development and testing, the resource name in the BASIC script must be renamed to match.

5.2.1 If a temperature is in an alarm state, send an email every hour.

```
DO
'If 55 < sensor1 < 185 then send an email every 1 hour
IF io.temp1 < 185 THEN
  IF io.temp1 > 55 THEN
    IF t0 = 0 THEN
      EMAIL
      LET t0 = 36000      '3600 seconds
    END IF
  END IF
END IF

LOOP
END
```

5.2.2 School bell controller offers lockdown/alert bell sequence via the control page

The control page has two buttons labeled “Ring 3:1” and “Ring 1:3” for ringing the bells with different duty cycles. The buttons respectively set register1 and register2 to 1 (true). This script rings the appropriate bell pattern for 2-minutes if either button is activated. The bell is connected to relay 1 in this example.

'Script rings two different bell patterns for 2-minutes if either register1 or register2 is activated (true).

```

LET a = 0
LET b = 0
LET c = 0
LET d = 0

DO

IF io.register1 = 1 THEN
  'Set 2 minute timer if register1 turns on
  IF a = 0 THEN
    LET t1 = 1200    '120.0 seconds
    LET a = 1
  End IF
  'Turn off register1 and relay1 after timer expires
  IF t1 = 0 THEN
    IF a = 1 THEN
      LET io.register1 = 0
      LET io.relay1 = 0
      LET a = 0
    END IF
  END IF
END IF
ELSE
  LET t1 = 0
END IF

IF io.register2 = 1 THEN
  'Set 2 minute timer if register2 turns on
  IF b = 0 THEN
    LET t3 = 1200    '120.0 seconds
    LET b = 1
  End IF
  'Turn off register2 and relay2 after timer expires
  IF t3 = 0 THEN
    IF b = 1 THEN
      LET io.relay1 = 0
      LET io.register2 = 0
      LET b = 0
    END IF
  END IF
END IF
ELSE
  LET t3 = 0
END IF

'Setting the register to 0 allows canceling the alarm.
IF io.register1 = 0 THEN

```

```

  IF a = 1 THEN
    LET io.relay1 = 0
    LET a = 0
    LET t1 = 0
  END IF
END IF

IF io.register2 = 0 THEN
  IF b = 1 THEN
    LET io.relay1 = 0
    LET b = 0
    LET t3 = 0
  END IF
END IF

'register1, Relay1 bell pattern, 3 secs on, 1 sec off
IF t1 > 0 THEN
  IF io.relay1 = 0 THEN
    IF t2 = 0 THEN
      LET io.relay1 = 1
      LET t2 = 30
    END IF
  ELSE
    IF t2 = 0 THEN
      LET io.relay1 = 0
      LET t2 = 10
    END IF
  END IF
END IF

'register2, Relay2 bell pattern, 1 sec on, 3 secs off
IF t3 > 0 THEN
  IF io.relay2 = 0 THEN
    IF t4 = 0 THEN
      LET io.relay1 = 1
      LET t4 = 10
    END IF
  ELSE
    IF t4 = 0 THEN
      LET io.relay1 = 0
      LET t4 = 30
    END IF
  END IF
END IF

LOOP
END

```

5.2.3 Monitor 4 doors, send an Email if a door is open more than 5-minutes

Send an email if a door has been open for more than 5 minutes, repeat the email every 5 minutes thereafter while the door is open.

'Send an email alert after a door has been open for more than 5 minutes.

'Continuously set a timer for 5 minutes if the door is closed

'Setting initial timer values

'Using variables a-d allow simple changes to alarm times

LET a = 3000 'Input1 300.0 seconds

LET b = 3000 'Input2 300.0 seconds

LET c = 3000 'Input3 300.0 seconds

LET d = 3000 'Input4 300.0 seconds

LET t1 = a

LET t2 = b

LET t3 = c

LET t4 = d

'Begin main program, sequentially service each door.
DO

'If door1 is closed, then set timer for 5 minutes.

'If door1 is open, then send an email and reset timer after timer expires

'Door 1

IF io.input1 = 1 THEN

LET t1 = a

ELSE 'Else if door is open

IF t1 = 0 THEN

EMAIL io.input1

LET t1 = a

END IF

END IF

'Door2

IF io.input2 = 1 THEN

LET t2 = b

ELSE 'Else if door is open

IF t2 = 0 THEN

EMAIL io.input2

LET b

END IF

END IF

'Door3

IF io.input3 = 1 THEN

LET t3 = c

ELSE 'Else if door is open

IF t3 = 0 THEN

EMAIL io.input3

LET t3 = c

END IF

END IF

'Door4

IF io.input4 = 1 THEN

LET t4 = d

ELSE 'Else if door is open

IF t4 = 0 THEN

EMAIL io.input4

LET t4 = d

END IF

END IF

LOOP

END

5.2.4 Temperature controller with time triggered email alarm

If a temperature falls below 100, turn a heater on and set a 20-minute timer. If the timer expires before the heater turns off, send an email and turn on register1 to set an alarm on the control page. An email will be sent once every 20 minutes while in the alarm state.

```
LET a = 0

'Begin main program loop
DO

'Turn on the heater, set timer, and set flag if temp below 100
IF io.temp1 < 100 THEN
  IF a = 0 THEN
    LET io.relay1 = 1      'Turn heater on
    LET t1 = 12000        '20 minutes or 1200.0 seconds
    LET a = 1            'Turn flag on to indicate timer set
  END IF
END IF

'Turn off heater, timer, and flag if temp above 120
IF io.temp1 > 120 THEN
  LET io.relay1 = 0      'Turn heater off
  LET a = 0
  LET t1 = 0
END IF

'If timer reaches 0 and flag set that heater on, send email and turn on register1
IF a = 1 THEN
  IF t1 = 0 THEN
    LET io.register1 = 1  'Turn on register1 (can view on control panel)
    EMAIL io.temp1       'Send email
    LET t1 = 12000
  END IF
END IF

LOOP
END
```

5.2.5 Remote control a water pump

Register1 has a button on the control page with On/Off settings. Input1 is connected to a float switch, Relay1 controls the priming pump and Relay2 controls the main pump.

Start the pump when the user sets register1 (true).

- a) Prime the pump for 10 seconds.
- b) Insure the float level in tank is acceptable to turn the main pump on.
- c) If the float ever drops too far, turn the pump off and set register1=false.
- d) Turn pump off if the user sets register1=false.

```

LET a = 0          'pump-is-primed flag

DO

'If user wishes to start pump, check input1, then
prime pump
IF io.register1 = 1 THEN
  IF io.input1 = 1 THEN
    IF a = 0 THEN
      CALL primepump
      LET a = 1
    END IF
  ELSE
    LET io.register1 = 0
  END IF
END IF

'If user turns off register1, turn off pump
IF io.register1 = 0 THEN
  LET io.relay2 = 0
  LET a = 0
END IF

'If float drops, turn off pump
IF io.input1 = 0 THEN
  LET io.relay2 = 0
  LET io.register1 = 0
  LET a = 0
END IF

LOOP
END

```

'Prime the pump, wait 10 seconds, stop priming the pump
'and then turn on main pump if float level is still acceptable.

```

SUB primepump
LET io.relay1 = 1
LET t1 = 100      '10.0 seconds
DO WHILE t1 > 0  'wait 10 seconds
LOOP
LET io.relay1 = 0
IF io.input1 = 1 THEN
  LET io.relay2 = 1
END IF
END SUB

```

5.2.6 If a digital input is on, cycle an alarm relay on and off continuously

If input1 is on, turn relay1 on for one second then off for one second continuously.

'If input1 is off, relay will remain off.

DO

```
IF io.input1 = 1 THEN                                'Test for input = on
  IF t0 = 0 THEN
    IF io.relay1 = 1 THEN
      LET io.relay1 = 0
      LET t0 = 10
    ELSE
      LET io.relay1 = 1
      LET t0 = 10
    END IF
  END IF
ELSE                                                  'Turn off relay if input is off
  LET io.relay1 = 0
END IF
LOOP
```

5.2.7 Measure the running average frequency of a digital input

Increment a counter whenever input1 turns on. Every 10 seconds, set register1 to the average counts per second.

```
LET a = 0 'edge flag
LET b = 0 'accumulator

DO

'Count up whenever input1 turns on
IF io.input1 = 1 THEN
  IF a = 0 THEN
    b = b + 1
    LET a = 1
  END IF
ELSE
  LET a = 0
END IF

'Every 10 seconds, readjust the average counts / second
IF t1 = 0 THEN
  LET io.register1 = b / 10
  LET b = 0
  LET t1 = 100 '10.0 seconds
END IF

LOOP
END
```

5.2.8 Send an email if the AC power fails

Send an email if the AC power (via input1) has been off for 60 seconds. Send a followup email when the power is restored. Send the power restored email only if a 'power off' email was previously sent.

Note: A simple AC to 12VDC wall transformer connected to the digital input can be used to detect the loss of AC power.

'Script will send an email after power has been off for a specific amount of time.
'Will also send an email when power is on only if a 'power off' email has been sent.

```
LET a = 0 'Power on email sent if true
LET b = 0 'Power off email sent if true

DO

IF io.input1 = 1 THEN                                'If power is on
  LET t1 = 600
  IF a = 0 THEN                                      'If no 'power on' email has been sent
    IF b = 1 THEN                                    'If 'power off' email has been sent
      EMAIL io.input1
      LET a = 1 'Set power on email sent flag
    END IF
  END IF
  LET b = 0
END IF

IF t1 = 0 THEN                                      'Once power has been off a specific time
  IF b = 0 THEN
    EMAIL io.input1
    LET b = 1 'Set power off email sent flag
  END IF
END IF

LOOP
END
```

5.2.9 Monitor a generator. Send an email if it runs for more than 10 seconds.

Send an email if a generator ever turns on for more than 10 seconds, and every 30 minutes afterward. Send an email when the generator turns off if a 'generator on' email was sent.

```
'Input1 is used as the source for the generator status
'Input1 = 1 : Generator off
'Input1 = 0 : Generator on

LET a = 0           'Generator on email sent flag
LET t1 = 100       '10.0 seconds

DO

'Generator off
IF io.input1 = 1 THEN
  LET t1 = 100     '10.0 seconds
  IF a = 1 THEN   'If generator on already email sent
    EMAIL io.input1 'Email everything okay
    LET a = 0     'Set generator on flag back to false
  END IF
END IF

'Generator on and timer expires
IF t1 = 0 THEN   'If timer has expired
  EMAIL io.input1 'Email generator on
  LET t1 = 18000 '30 minutes until another email
  LET a = 1     'generator on email flag
END IF

LOOP
END
```

5.2.10 Automatic generator start

If the battery voltage (Vin) is low, automatically start a generator and run for 4 hours. If relay1 is on, and the VIN voltage is less than 12V, turn the ignition switch on and pulse the start switch to start the generator. Send an email. Turn the ignition switch off after 4 hours. The length of the starter pulse is configured in the settings for relay 2. Relay 1 can be used to illuminate a warning light at the generator indicating it may start automatically.

Vin = battery voltage

Relay 1 = auto-start enable (Used to enable the script and can also be used to illuminate a warning light)

Relay 2 = ignition switch

Relay 3 = start switch

```
DO
IF io.relay1 = 1 THEN
  IF io.vin < 12.0 THEN
    LET io.relay2 = 1      'Turn on ignition switch
    LET io.relay3 = 2      'Relay function-2 pulses start button
    EMAIL                  'Send email
    CALL delay             'Run for 4 hours
    LET io.relay2 = 0      'Turn off ignition switch
  END IF
END IF

LOOP
END

SUB delay
  LET t1 = 144000          'Timer to 4hrs
  DO WHILE t1 > 0
  LOOP
END SUB
```

Section 6: Auxiliary Operations

6.1 XML

Custom computer applications may be created to monitor and control the X-410. This method does not use a web browser. There are two XML pages that can be used to monitor and control the X-410, `state.xml` and `customState.xml`. All requests to the XML files must be in the form of HTTP GET requests, see *Section HTTP GET Requests (for custom applications)* for details.

See *Section External Server and Remote Services* for more information on network configurations when using XML.

6.1.1 `state.xml`

The `state.xml` page only shows the local I/O on the X-410. The XML tag names on this page are hard-coded and cannot be modified. They represent the io type and io number on the device. Some values may or may not show depending on the I/O configuration.

Reading state.xml

XML Monitor All Functions

The state of the Relays, Inputs, Counters, Sensors, and Vin can be monitored by sending a request to port 80 (or port specified in setup). This can be demonstrated by entering the following URL into the address bar of a web browser (substituting the IP address as necessary):

```
http://192.168.1.2/state.xml
```

The following `state.xml` page is returned:

```
<datavalues>
  <digitalInput1>0</digitalInput1>
  <onTime1>0.00</onTime1>
  <totalOnTime1>0.00</totalOnTime1>
  <digitalInput2>0</digitalInput2>
  <count2>0.00</count2>
  <digitalInput3>0</digitalInput3>
  <frequency3>0.00</frequency3>
  <digitalInput4>0</digitalInput4>
  <relay1>1</relay1>
  <relay2>0</relay2>
  <relay3>0</relay3>
  <relay4>0</relay4>
  <vin>9.577</vin>
  <register1>0.00</register1>
  <oneWireSensor1>x.x</oneWireSensor1>
  <utcTime>1504735541</utcTime>
  <timezoneOffset>-21600</timezoneOffset>
  <serialNumber>00:0C:C8:00:00:00</serialNumber>
</datavalues>
```

The numbers enclosed by the tags, `<tag>`, indicate the current state or value monitored by the X-410. Values for each tag are described in the table below.

Custom computer applications can open a TCP/IP connection with the X-410 and send a `GET` request for the `state.xml` file to obtain the current state of the X-410. Parameters can be passed with the `GET` request to control relays on the X-410. (See *Section HTTP GET Requests (for custom applications)* for instructions on using `GET` requests to monitor and control the X-410.)

| XML Tags* | Monitor Values |
|------------------|--|
| <digitalInputX> | 0=off (voltage not applied to input one) 1=on (voltage applied to input one) |
| <onTimeX> | Time in seconds how long the input was on since last coming on |
| <totalOnTimeX> | Total time in seconds how long the input has been on |
| <countX> | The count value associated with the input |
| <frequencyX> | The frequency associated with the input |
| <relayX> | 0=off (coil one off) 1=on (coil one energized) |
| <vin> | Scaled internal Vin measurement |
| <registerX> | Value of the register |
| <oneWireSensorX> | x.x = Indicates that the 1-Wire sensor could not be read 77.3 = Current sensor value 77.3 F = Current sensor value with units included using param showUnits=1 |
| <utcTime> | Current UTC time expressed in seconds since January 1 st , 1970 |
| <timezoneOffset> | Value to offset utcTime for local time |
| <serialNumber> | 00:00:00:00:00:00, serial number of X-410. |

* 'X' is replaced by the input, relay or sensor number.

Controlling with state.xml

Commands can be sent to the X-410 to control the relays, counters, and registers. The parameters used differ depending on if state.xml is used or customState.xml is used. State.xml uses the io type names and io numbers when controlling the I/O. CustomState.xml uses the camelcase version of the user configurable name when controlling the I/O.

Relay State Control

Commands are sent using the parameter composed of the io type and relay number relayX (X is replaced by 1 for relay 1, or 2 for relay 2, etc). A few examples of using relayX are given here.

| Command | Description |
|--------------------|------------------|
| state.xml?relay1=0 | Turn Relay 1 OFF |
| state.xml?relay1=1 | Turn Relay 1 ON |
| state.xml?relay2=0 | Turn Relay 2 OFF |
| state.xml?relay2=1 | Turn Relay 2 ON |

Pulse Relay

When the pulse command is sent, the output will turn ON for the Pulse Duration specified in the *Relay setup page*. It is also possible to send a pulse time command that is different than the configured Pulse Duration. This is done by sending a pulseTime variable. The pulseTime variable does not change the Pulse Duration in the setup page and it is not stored or recorded. The pulseTime variable only changes the duration for the single pulse initiated by that command. In other words, you must issue the pulseTime command for each pulse command that differs from the preset value. For example, if the X-410 is configured for a pulse duration of 1.5 seconds. To issue one 1.5 second pulse, three 5 second pulses, and another 1.5 second pulse to relay 1, you would issue the following commands:

| Command | Description |
|---------------------------------|--|
| state.xml?relay1=2 | Pulse Relay 1 for the preset time (1.5 seconds). |
| state.xml?pulseTime1=5&relay1=2 | Pulse Relay 1 for 5 seconds. |
| state.xml?pulseTime1=5&relay1=2 | Pulse Relay 1 for 5 seconds. |
| state.xml?pulseTime1=5&relay1=2 | Pulse Relay 1 for 5 seconds. |
| state.xml?relay1=2 | Pulse Relay 1 for the preset time (1.5 seconds). |

NOTE: The pulseTime argument MUST come before the relay=2 command.

XML Set On Time Counters

The on time counter and total on time counter values can be set using the `onTimex` and `totalOnTimex` commands respectively:

| Command | Description |
|--------------------------|-------------------------------------|
| state.xml?onTime1=0 | Reset the onTime1 counter to 0 |
| state.xml?onTime1=5 | Reset the onTime1 counter to 5 |
| state.xml?totalOnTime1=0 | Reset the totalOnTime1 counter to 0 |
| state.xml?totalOnTime1=5 | Reset the totalOnTime1 counter to 5 |

XML Set Counter

The counter values can be set using the `countx` command:

| Command | Description |
|----------------------|----------------------|
| state.xml?count1=200 | Set counter1 to 200. |

XML Set Register Values

The register values can be set using the `registerx` command:

| Command | Description |
|--------------------------|------------------------|
| state.xml?register1=10.5 | Set register1 to 10.5. |

6.1.2 customState.xml

The `customState.xml` works very similarly to the `state.xml` page in that current control data is presented and made available to control. The difference is in the `customState.xml`, the XML tag names are set to a name very similar to the name of the I/O it is associated with. For example, if you were to set the name of 'Relay 1' to 'My Relay 1' the relay would show in the `customState.xml` in the tags 'myRelay1'. Using these names allows applications interfacing with the X-410 to use more appropriate names when reading and writing I/O values.

Controlling I/O with the `customState.xml` is the same as with the `state.xml` except you may now use the names shown in the XML tags. For example, if you wanted to turn on a relay named 'My Relay 1', you would use the following command:

```
http://192.168.1.2/customState.xml?myRelay1=1
```

You will need to reference the `customState.xml` for the exact names to use for each of the configured I/O.

6.2 JSON

The X-410 can also allow reading the current state of the devices I/O through JavaScript Object Notation (JSON). The JSON format may be preferred for some custom applications as some languages provide native methods for processing data in JSON form.

There are two primary files that can be requested from the X-410 in JSON form. The `state.json` and the `customState.json`. Each of these files provide the same information as their XML counterparts, but will be formatted with JSON. Additionally, the methods of controlling the I/O will be the same as with the XML pages. Note that all requests to the JSON files must be HTTP GET requests, see *Section HTTP GET Requests (for custom applications)*

6.3 HTTP GET Requests (for custom applications)

The X-410 has a built-in web server that responds to HTTP GET requests. These GET requests are sent from web browsers when a web page is requested. They are fairly similar to the actual addresses seen in the browser's address bar. The following section describes the HTTP protocol and how it can be used to control and monitor the X-410. All examples below show the state.xml, but will be the same for customState.xml and the JSON files. It is also assumed that a TCP/IP connection has already been established from the custom application to the device. The following are the messages that should be sent over the TCP/IP connection to control and monitor the device.

6.3.1 Using GET for Control and Monitoring

No Password

GET requests to the device for XML files.

Example request state.xml:

```
GET /state.xml HTTP/1.1\r\n\r\n
```

Example turn Relay1 On:

```
GET /state.xml?relay1=1 HTTP/1.1 \r\n\r\n
```

Password Enabled

If the *User* account is enabled on the X-410 and the state.xml page is requested through a browser, the user will be prompted for a password. If the request is sent from custom application, the HTTP request will need to contain the password encoded as Base64.

The following is an HTML request header without the password:

```
GET /state.xml?relay1=1 HTTP/1.1 (Terminated with two \r\n.)
```

The following example adds the password:

```
GET /state.xml?relay1=1 HTTP/1.1 (Terminated with one \r\n.)  
Authorization: Basic bm9uZTp3ZWJyZWxheQ== (Terminated with two \r\n.)
```

bm9uZTp3ZWJyZWxheQ== is the Base64 encoded version of the user "name:password,"
none:webrelay.

6.4 SNMP Requests, Objects and Community Strings

All configured I/O, and some simple network parameters can be retrieved using Simple Network Management Protocol (SNMP). For most cases, using SNMP is as simple as locating the appropriate Management Information Bases (MIB) files and loading them into the SNMP manager software. The X-410 will generate an MIB file based on its I/O configuration for use with the SNMP manager software. If the I/O are configured (added/deleted), a new MIB will need to be generated.

SNMP is configured under the *Advanced Network* setup tab. See *Section General Settings Tab > ADVANCED NETWORK SETTINGS* for more information.

The X-410 supports the following Packet Data Units (PDU):

- GetRequest
- GetNextRequest
- GetBulkRequest
- SetRequest
- Trap
- Notification

6.4.1 Standard Objects

The X-410 supports several standard RFC1213 objects that usually come with SNMP management software. If not, an Internet search for RFC1213-MIB will turn up multiple links.

| RFC1213 Object | Response |
|--------------------|---|
| system.sysDescr | X-410 |
| system.sysObjectID | X410 |
| system.sysUpTime | Time in hundredths of seconds since X-410 was last powered. |
| system.sysName | X-410* |

*The sysName is customizable under the **Control Page** setup tab. It's the Control Page header.

6.4.2 X-410 Objects

All configured I/O on the X-410 can be monitored and controlled through SNMP. The MIB file can be generated for the X-410 by going to General Settings Tab > ADVANCED NETWORK SETTINGS and pressing the button Generate and Download MIB File. This file should be regenerated whenever there are changes made to the I/O.

6.4.3 TRAPS

The X-410 can send SNMP traps when an input or relay changes state, when a particular sensor value is reached, or when the supply voltage is out of the desired range. Traps are configured as actions in Conditional and Scheduled Tasks. As more I/O are added to the X-410, more I/O will appear in the MIB file.

6.4.4 Notifications

The X-410 also supports sending of SNMP Notifications when the SNMP version is 2c or 3. Notifications

are similar to traps except they require a response to be sent back from the SNMP manager. Retries will occur if the SNMP manager does not return a response. This makes notifications more reliable than Traps. Notifications are configured as actions in Conditional and Scheduled Tasks.

6.4.5 Community Strings

The X-410 allows customization of both the read and write community strings. The proper community string will be needed for all read and write requests. By default both read and write community strings are `webrelay`. Community strings are only used by SNMP versions 1 and 2c. SNMP version 3 uses a different security mechanism.

6.4.6 SNMP V3 User-Based Security Model

The X-410 supports the SNMP V3 User-Based Security Model (USM). This replaces the community strings “security” of SNMP V1 and 2C. The details of USM can be complicated, but the main thing is that both the X-410’s security settings and the SNMP Manager’s security settings need to match for it to work.

There are two protocols used for USM. The first authentication protocol, allows the SNMP manager to authenticate the X-410 and vice versa. The second privacy protocol, allows the SNMP communication to be encrypted. Each protocol has an “algorithm” and a password associated with it. There is also a security username that is shared by both protocols.

6.5 External Server and Remote Services

Note: The following methods are supported by the X-410; however, Xytronix Research & Design, Inc. does not provide or support custom third-party applications, or external web servers.

6.5.1 Accessing the X-410 with custom software or third party applications

Custom applications can send commands to the X-410 for monitoring and control functions using HTTP requests for XML or JSON files. (See *Section XML* and *JSON* for more information) The application interface can be used to provide a custom user interface, access to multiple units in a single screen, and allow for automation, logging, and other application-specific features.

6.5.2 Using an External Web Server

Rather than accessing the X-410 directly from a computer, an external web server can be used. The term “external” web server is used here to mean a separate web server (such as Apache, IIS, or NGINX) that is not the web server built into the X-410. In this scenario, users access custom web pages that reside on the external web server and the external web server communicates with the X-410.

An external web server can integrate multiple ControlByWeb products into a single control page. In other words, the user may not be aware that he/she is using multiple ControlByWeb™ devices, but rather the user sees an integrated control page for the entire system. In addition, the use of an external web server allows programmers to create custom user interfaces that take advantage of the additional resources typically available on larger web servers, including more memory and various web programming languages.

There are two approaches that an external server can use to communicate with the X-410 and other ControlByWeb™ devices, *Direct Server Control* and *Remote Services*.

Direct Server Control

The first approach is for the external server to create a TCP connection whenever it needs to access the X-410. In this case, the external server opens the connection, sends commands and/or reads the device, and closes the connection.

This method is ideal when the web server and all of the X-410 devices are on the same network (without routers between them). In this case, the server can communicate with the X-410 devices directly and securely since data never has to leave the local network.

When the server and the X-410 are on different networks, routers must be configured to allow appropriate access. If a public network is used, such as the Internet, security precautions should be considered.

Remote Services

The second approach is for the X-410 to initiate a connection using *Remote Services*. The settings under the *Advanced Network* tab in the setup pages will enable the X-410 to open a TCP connection with an external server. Once the connection is open, the external server can send commands and/or read the device. The external server can leave the connection open (so that it never closes) or close the connection.

Remote Services is ideal for installations where the server and the X-410 are installed on different networks. This is especially useful when each X-410 is installed on a separate private network. For example, if the user doesn't control the network connections where the X-410 is installed, *Remote Services* would initiate a TCP connection over the Internet with the control computer. Since the X-410

initiates the connection, the control computer doesn't have to know the IP address of the X-410. This means that the X-410 can be installed using DHCP. In addition, no special router configuration is required. This makes the network installation of the X-410 very simple, and since no incoming ports need to be opened in the router, security is not compromised. See *Section General Settings Tab > ADVANCED NETWORK SETTINGS* for more information.

The X-410 can be configured to establish a connection when triggered by an event, such as an I/O state changing. This is done by setting a conditional task with the action being *Send Device State to Remote Service*.

When an event occurs and a connection is open, the state.xml file is sent.

If a connection is not open and *Remote Services* is enabled, a connection will be established by sending the connection string.

Connection String

With *Remote Services* enabled, a connection attempt will be made periodically according to the Connection Interval setting in the *Advanced Network* setup tab. The Connection String consists of static information about the device, a user-defined character string configured in the *Advanced Network* tab and ends with sending the state.xml.

The connection string is also sent at the same interval once the connection is open. The external server is responsible for closing the connection when it is done.

A three-character "ACK" response is expected in return to every connection string. If the "ACK" is not received within 10 seconds, the X-410 will close the connection.

6.6 Log Files

The X-410 logs information to two different log files; log.txt and syslog.txt. Both log files are text files and are stored in nonvolatile memory; this data will not be lost due to power failure and the syslog.txt is not cleared when restoring factory defaults. The log files are stored in circular buffers which write from the beginning of the allocated memory space to the end and then repeat from the beginning (over-writing the original data). The nonvolatile memory is divided into 4K byte sectors. Each time data gets erased to make room for new data, a full sector (4K bytes) is erased at one time.

Data Log File – log.txt

This log file is user-configurable under the *Logging* tab, and stores real-world data such as temperatures and events such as relay state changes (see *Section Logging Tab > GENERAL LOGGING SETTINGS* for more information). It can be up to 512K bytes long and is displayed using a comma-separated value formatting scheme.

Inputs, Relays, Counters, Vin, and Sensors will only be displayed if they are selected in the *Logging* setup tab. The file is read by requesting the log.txt file from the X-410. For example, using the default IP address the following command would be used to request the log file:

```
http://192.168.1.2/log.txt
```

Example File Format:

```
MM/DD/YYYY HH:MM:SS.mmm DDD, Input 1-4, Relay 1-4, Counters 1-2, Vin, Sensors  
1-16, Trigger: Source
```

Date and Time Format:

MM – Month (1-12)

DD – Day (1-31)

YYYY – Year (1970 - 2106)

HH – Hour in 24 hour time (0 -23)

MM – Minutes (0-59)

SS – Seconds (0-59)

mmm – Milliseconds

DDD – DST when in daylight savings; STD when not in daylight savings time

Sample File:

```
Date Time,Relay 1,Relay 2,Relay 3,Relay 4,Digital Input 1,Digital Input
2,Digital Input 3,Digital Input 4,Vin(V),Register 1,Trigger
09/07/2017 13:56:18 DST,0,1,1,0,0,0,0,0,24.74,0.00,I/O:(Relay 2)
09/07/2017 13:56:18 DST,0,0,1,1,0,0,0,0,24.74,0.00,I/O:(Relay 1)
09/07/2017 13:56:18 DST,1,0,0,1,0,0,0,0,24.74,0.00,I/O:(Relay 2)
09/07/2017 13:56:18 DST,1,1,0,0,0,0,0,0,24.74,0.00,I/O:(Relay 1)
09/07/2017 13:56:18 DST,0,1,1,0,0,0,0,0,24.74,0.00,I/O:(Relay 2)
09/07/2017 13:56:18 DST,0,0,1,1,0,0,0,0,24.74,0.00,I/O:(Relay 1)
09/07/2017 13:56:18 DST,1,0,0,1,0,0,0,0,24.74,0.00,I/O:(Relay 2)
09/07/2017 13:56:18 DST,1,1,0,0,0,0,0,0,24.74,0.00,I/O:(Relay 1)
09/07/2017 13:56:18 DST,1,1,0,0,0,0,0,0,24.74,0.00,I/O:(Relay 1)
09/07/2017 13:56:18 DST,0,1,1,0,0,0,0,0,24.74,0.00,I/O:(Relay 2)
09/07/2017 13:56:18 DST,0,1,1,0,0,0,0,0,24.74,0.00,I/O:(Relay 2)
09/07/2017 13:56:18 DST,0,0,1,1,0,0,0,0,24.74,0.00,I/O:(Relay 1)
09/07/2017 13:56:18 DST,1,0,0,1,0,0,0,0,24.74,0.00,I/O:(Relay 2)
09/07/2017 13:56:18 DST,1,1,0,0,0,0,0,0,24.74,0.00,I/O:(Relay 1)
09/07/2017 13:56:18 DST,1,1,0,0,0,0,0,0,24.74,0.00,I/O:(Relay 1)
09/07/2017 13:56:18 DST,0,1,1,0,0,0,0,0,24.74,0.00,I/O:(Relay 2)
09/07/2017 13:56:18 DST,0,0,1,1,0,0,0,0,24.74,0.00,I/O:(Relay 1)
09/07/2017 13:56:18 DST,1,0,0,1,0,0,0,0,24.74,0.00,I/O:(Relay 2)
09/07/2017 13:56:18 DST,1,1,0,0,0,0,0,0,24.74,0.00,I/O:(Relay 1)
09/07/2017 13:56:18 DST,0,1,1,0,0,0,0,0,24.74,0.00,I/O:(Relay 2)
09/07/2017 13:56:18 DST,0,0,1,1,0,0,0,0,24.74,0.00,I/O:(Relay 1)
09/07/2017 13:56:18 DST,1,0,0,1,0,0,0,0,24.74,0.00,I/O:(Relay 2)
09/07/2017 13:56:18 DST,1,1,0,0,0,0,0,0,24.74,0.00,I/O:(Relay 1)
```

The file can then be saved using the 'Save As...' option under the 'File' menu of the web browser. If the TCP port has been changed (not port 80), the port will be required to read the file. For example, using the default IP address, and port 8000, the log file would be read as follows:

```
http://192.168.1.2:8000/log.txt
```

The log.txt file may be erased with the following command:

```
http://192.168.1.2/log.txt?erase=1
```

Note: If the User account is enabled in the setup pages, the password will be required to access the log file.

System Log File – syslog.txt

The syslog file records various system events, which can be used for diagnostics and troubleshooting purposes.

File Format:

```
MM/DD/YYYY HH:MM:SS, (category to which message applies): (message)
```

Sample File:

```
01/02/2010 04:08:13 DEVICE: Power Up.
01/01/2010 00:41:05 DEVICE: Reset factory defaults.
```

Listed below is a description of messages that a user may see:

| Category | Message | Description |
|---------------|----------------------------|---|
| DEVICE | Power Up | Device has been properly powered. |
| | Initialize | Device is ready. |
| | Reset Factory Defaults | Device has been reset to factory defaults. |
| EMAIL | Failed DNS Lookup | Unable to lookup mail server due to an incorrect DNS setting. |
| | Bad Username | Email was not sent due to an incorrect user name. |
| | Bad Password | Email was not sent due to an incorrect password. |
| | Authentication Required | A user name and password are required by the mail server. |
| | No Response | No response from SMTP server. |
| CLOCK | RTC Reset | Real Time Clock has been reset. |
| NTP SERVER | Request Attempt | Device attempting to connect to NTP Server. |
| | Failed DNS Lookup | Unable to lookup NTP server name due to an incorrect DNS setting. |
| | Success | Device successfully connected to NTP Server. |
| REMOTE SERVER | Failed DNS Lookup | Unable to lookup Remote Server due to an incorrect DNS setting. |
| | Connection Attempt Started | Connection port with Remote Server has been opened. |
| | Connection Closed | Connection port with the Remote Server has been closed. |
| DHCP | Address Acquired | IP address request successful, and IP address assigned. |
| | Lease Renewal | IP address assigned to device was renewed. |
| MAIN_MCU | New Firmware Loaded | New firmware has been loaded to the device. |

This file is read by requesting the syslog.txt file. For example, using the default IP address the following command would be used:

```
http://192.168.1.2/syslog.txt
```

Note: The setup user name and password are required to access this file.

If the TCP port has been changed (not port 80), the port will be required to read the file. For example, using the default IP address, and port 8000, the log file would be read as follows:

```
http://192.168.1.2:8000/syslog.txt
```

To erase the file, use: <http://192.168.1.2/syslog.txt?erase=1>

6.7 Modbus/TCP

The X-410 can be controlled and monitored using Modbus/TCP protocol. This provides a standard means of using the X-410 with devices and software from other manufacturers. This section is not a tutorial on Modbus and it is assumed that the reader is already familiar with Modbus. Detailed Modbus information can be found at <http://www.modbus.org>.

Note: Modbus communications are disabled whenever the User account is enabled. This is because Modbus/TCP does not provide a mechanism for password protection. Make sure the User account is disabled (default) and Modbus functionality is enabled on the Advanced Network.

The X-410 functions as a Modbus slave. Host devices, such as PLCs, open a connection with the X-410 on port 502 (configurable under *Advanced Network* tab) and then send requests to read or set relay states, read input states, or sensor values. When the X-410 receives a command, it performs the desired function and returns a response.

The X-410 can have additional I/O added and removed that can cause changes to the Modbus address map. For an up-to-date map of I/O on the X-410 to the addresses for Modbus, please select the *View Modbus Address Table* button from the setup pages under the *Advanced Network* tab.

The following sections provide an overview and explanation of Modbus operation.

6.7.1 X-410 Function Code Summary

The X-410 supports the following function codes:

| Code Name | Modbus Function | X-410 Feature |
|--------------------------|-----------------|--|
| Read Coils | 01 | Relays |
| Read Discrete Inputs | 02 | Digital Inputs |
| Read Multiple Registers | 03 | Vin, Sensors, Registers, Counters (All I/O) |
| Write Single Coil | 05 | Relays |
| Write Multiple Coils | 15 | Relays |
| Write Multiple Registers | 16 | Relay Pulse Counters, Registers, Counters (All writable I/O) |

Multiple commands may be sent without closing and re-opening the connection, but if no data is transferred for 50 seconds, the connection will time out and close. To keep the connection open, a read request can be sent periodically.

The X-410 has two TCP sockets available for Modbus/TCP. This allows two connections to be open at one time. Requests for more than two open connections will be rejected.

When errors occur, an error code is returned. Most Modbus client software will interpret this code in a human readable form. The code is comprised of the original function code plus 0x80. For example, an error during the read coils function 0x01 would return 0x81. Each error has a qualifying exception number. The following are the possible exception codes and their meanings:

0x01 - Function code not supported (also when Modbus is disabled in the setup pages).

0x02 - Incorrect starting address/quantity of output combination.

6.7.2 Read Coils - Modbus Function Code 01 (0x01)

Read the state of the relays.

Request

Start Address: 0x0004 (coil 1) to 0x0007 (coil 4)

Coil Quantity: 0x0001 (1 coil) to 0x0004 (4 coils)

Both Outputs may be read at the same time by specifying the correct starting address and quantity of coils to be read.

Response

The X-410 will respond to the request with a data field of one byte, each bit representing the coil status. A '1' indicates the Output is *ON*. A '0' indicates that the Output is *OFF*.

Bit zero of the return value will be the state of the coil corresponding to the start address. For example, if a start address of 0x0001 is used, bit zero will be the status of Relay 2.

| Coil State Byte | | | | | | | |
|-----------------|---|---|---|---------|---------|---------|---------|
| Bit 7 | 6 | 5 | 4 | 3 | 2 | 1 | Bit 0 |
| X | X | X | X | Relay 4 | Relay 3 | Relay 2 | Relay 1 |

Errors

The sum of the start address and coil count cannot exceed the maximum coil count or an error response will be returned.

The following are possible error responses:

| | |
|--|---|
| Coil Read Error Function Code (1 byte): | 0x81 |
| Exception Codes (1 byte): | 0x01 – Function code not supported. 0x02 – Incorrect combination of start address and quantity of Relays |

6.7.3 Read Discrete Inputs – Modbus Function Code 02 (0x02)

This function returns the state of the digital inputs.

Request

Start Address: 0x0000 (input1) to 0x0003 (Input 4)

Input Quantity: 0x0001 to 0x0004

The sum of the starting address and the quantity of coils must not be greater than 0x0004. For example, if you want to read 0x0002, both inputs, then the start address must be 0x0000. To read the second input only the start address is 0x0001 with a quantity of 0x0001.

Response

The inputs states are indicated by bits one and two of the status byte. A 1 indicates that the input is switched *ON*. A 0 indicates that the input switched *OFF*. Bit zero of the return value will be the state of the coil corresponding to the start address. For example, if a start address of 0x0001 is used, bit zero will be the status of input 2.

When reading all 4 inputs, the following table shows the bit positions:

| Discrete Input State Byte | | | | | | | |
|---------------------------|---|---|---|---------|---------|---------|---------|
| Bit 7 | 6 | 5 | 4 | 3 | 2 | 1 | Bit 0 |
| X | X | x | x | Input 4 | Input 3 | Input 2 | Input 1 |

Errors

Input Read Error Function Code (1 Byte): 0x82

| | |
|----------------------------------|---|
| Exception Codes (1 byte): | 0x01 – Function not supported. |
| | 0x02 – Incorrect combination of start address and input quantity. |

6.7.4 Read Holding Registers – Modbus Function Code 03 (0x03)

The Read Holding Registers function is used mainly to read analog I/O such as the registers, counters, vin and 1-Wire sensors. All I/O can be read using this function code, including digital I/O.

Request

32-bit sensor values are read from 16-bit register pairs. Consequently, sensors addresses and registers must be even numbers.

Vin Start Addresses

Start Address: 0x0010 (Vin)

Input Quantity: 0x0002

Temperature and Humidity Sensor Start Addresses

Start Address: Refer to Modbus map in setup pages

Input Quantity: Varies and must be an even number

Counter Input Start Addresses

Start Address: Refer to Modbus map in setup pages

Input Quantity: Varies and must be an even number

Response

32-bit floating-point values are returned, either as little-endian or big-endian numbers, depending on the configuration in the *Advanced Network tab*.

With little-endian ordering, a temperature reading of sensor 1 would return 0x800042A2. The least significant word would be 8000 hex and the most significant word would be 42A2. This hexadecimal value converts to a temperature reading of 81.25 degrees.

If a temperature or humidity sensor is not installed, a value of 0xFFFFFFFF (NaN) is returned. Other inputs will show measured values of the open circuits.

Errors

| | |
|--|---|
| Sensor Read Error Function Code (1 byte): | 0x83 |
| Exception Codes (1 byte): | 0x01 – Function not supported. 0x02 – Incorrect combination of start address and input quantity. |

6.7.5 Write Single Coil – Modbus Function Code 05 (0x05)

Relays may be controlled one at a time.

Request

| | |
|---------------------------------|-------------------------------------|
| Start Address (2 bytes): | 0x0004 (Relay 1) – 0x0007 (Relay 4) |
| Output Value (1 byte): | 0x00 (OFF), 0xFF(ON) |
| Padding (1 byte): | 0x00 |

Response

The response mirrors the requested state, 0x00 or 0xFF.

Errors

| | |
|--|---|
| Single Coil Write Error Function Code (1 Byte): | 0x85 |
| Exception codes (1 Byte): | 0x01 – Function not supported. 0x02 – Address out of range. 0x03 – Padding value. |

6.7.6 Write Multiple Coils - Modbus Function Code 15 (0x0F)

One byte can be written to set the state of all relays, each bit representing one relay.

Request

Relay states are controlled by specifying the start address of the first relay to be controlled, the count of the relays to be affected, and the relay state byte.

A relay value of 0xFFFF would be used to turn *ON* all of the relays in the range or 0x0000 to turn them *OFF*. In the above example, the relay value 0xFF would turn relays 1-4 *ON*.

Start Address (2 bytes): 0x0004 (Relay 1) – 0x0007 (Relay 4)
 Output Quantity (2 bytes): 0x0001 – 0x0004
 Byte Count (1 byte): 0x01
 Relay Value (1 byte): 0x00 – 0x0F

| Relay State Byte | | | | | | | |
|------------------|---|---|---|---------|---------|---------|---------|
| Bit 7 | 6 | 5 | 4 | 3 | 2 | 1 | Bit 0 |
| X | X | X | X | Relay 4 | Relay 3 | Relay 2 | Relay 1 |

Response

The quantity value is returned.

Errors

| | |
|--|---|
| Multiple Coil Write Error Function Code (1 Byte): | 0x8F |
| Exception codes (1 Byte): | 0x01 – Function not supported 0x02 – Incorrect combination of start address and Relay quantity 0x03 – Byte count out of range |

6.7.7 Write Multiple Registers – Modbus Function Code 16 (0x10)

The Modbus Write Multiple Registers function can be used to set a counter to a specific value or pulse the relays.

Request

Set Counters, Registers and other analog values

The counter value is specified using a 32-bit integer (not a floating point number).

| | |
|--|---------------------------------------|
| Start Address (2 bytes): | Refer to Modbus map in setup pages |
| Register Quantity (2 bytes): | Varies and must be an even number |
| Byte Count (1 byte): | Varies and must be a multiple of four |
| Counter Quantity (4 bytes/Counter): | 0x00000000 – 0xFFFFFFFF |

Pulse Relay

The Modbus Write Multiple Registers function is used to pulse the relay(s) for a specified time. When the X-410 receives this command, it immediately turns the appropriate relay(s) *ON* (if not already on) and starts the pulse timer. The relay(s) are selected by writing the pulse time in seconds to the register(s) associated with the desired relay(s).

The pulse time is specified using floating point format in the register value field and can range from 0.1 seconds to 86400 seconds (1 day). When the pulse time expires, the relay will be turned *OFF*. If a pulse time command is sent with a value greater than 86400, the pulse timer will be set to 86400. If a pulse time command is sent with a value less than 0.1, the pulse timer will be set to 0.1.

If any commands are sent to the X-410 (Modbus, XML, SNMP, or HTML) before the pulse timer has expired, the pulse timer will be canceled immediately and the new command will be executed.

IEEE 754 floating point format is used for the pulse time. The X-410 may be configured for little-endian or big-endian transmission. The endian-ness is configured in the *Advanced Network* tab. (See MODBUS for more information.)

| | |
|--|--|
| Start Address (2 bytes): | 0x0208 (relay 1) – 0x020E (relay 4) |
| Register Quantity (2 bytes): | 0x0002 – 0x0008 (2 registers for each relay, even number) |
| Byte Count (1 byte): | 0x04 – 0x10 (Multiples of 4) |
| Pulse Duration (4 bytes/relay): | 0x3DCCCCC – 0x47A8C000 (big-endian) 0xCCCC3DCC – 0xC00047A8 (little-endian) |

Response

The request is acknowledged by responding with the register quantity that was requested.

Errors

| | |
|--|--|
| Pulse Function code Error (1 Byte): | 0x90 |
| Exception codes (1 Byte): | 0x01 – Feature not supported. 0x02 – Address quantity not an even number. Incorrect combination of start address and relay count. |

6.8 Basic Scripts

BASIC (Beginners All-purpose Symbolic Instruction Code) is a computer programming language that has been in use for many years. The X-410 has an integrated BASIC interpreter for a simple BASIC script. This provides a great deal of flexibility by allowing users to customize basic functions of the unit. The interpreter only supports a small subset of the BASIC commands that are available for larger computers. Some non-standard commands have been added, and some commands may function differently on the X-410 BASIC interpreter than on other platforms. The following is a short tutorial on the supported BASIC functions.

Example scripts are available at <https://www.controlbyweb.com/support/tutorials/basic-script-tutorial.html>. Contact customer support if further assistance is required.

6.8.1 Structure

A BASIC script is written as a .txt file, which is then uploaded to the device using the *Script* setup tab. The maximum script size is 4-Kbytes. Each line within the script contains a single statement. Line numbers are not used.

Statements are not case sensitive; however, variables are.

IF THEN, FOR loops, and DO loops can only be nested up to 5 times per command. For those not familiar with nesting, the following is an example of nested FOR loops:

```
FOR a = 0 to 100
  FOR b = 0 to 100
  NEXT b
NEXT a
```

Every program must end with an END statement. Subroutines would then follow after the END statement, if required. The last line of the script should be left blank.

6.8.2 Line Format

Every line follows the same format. The basic format is:

statement (variable) (=, <, >, <=, >=, <>) (expression) (THEN)

The fields in parentheses are optional depending on the statement. One space must be used between all statements, numbers, variables, operators, expressions, etc. Multiple spaces are invalid.

Comments may be inserted, but must begin with an apostrophe. All text on a line after the apostrophe is ignored. For example:

```
LET a=1           'this will return an error because of insufficient spacing
LET a = 1        'this is valid
LET a = 1        'this will return an error because of too many spaces
```

Only a single variable or literal is allowed on the left side of any operator. The following example is incorrect and will return an error. The error occurs because there is more than a single value to the left of the comparison operator (a + b is to the left of =).

```
IF a + b = 3 THEN 'this will return an error
```

To fix the above line, replace 'a + b'. One of the following options may be used:

```
Let c = a + b
IF c = 3 THEN
```

6.8.3 Supported Statements

The following are the statements supported by the ControlByWeb™ BASIC interpreter.

LET

The LET statement assigns a variable a value. The format is:

```
LET (variable) = (expression)
```

IF THEN, ELSE, END IF

The IF THEN statement tests the truth of a condition. The ELSE statement defines a second function if the condition is found false. In other words, if the condition is true, then a function is performed. If it is not true, a second function may be performed. The second function may or may not be necessary depending on the application. The IF THEN (ELSE) statement must always be followed with an END IF statement. The format is:

```
IF (variable) (=, <, >, <=, >=, <>) (expression) THEN  
  (Function 1)  
ELSE  
  (Function 2)  
END IF
```

A special Variable NAN is available to check if I/O values are valid before using them. To check if a 1-Wire temperature sensor value is valid before using it to send an email the following could be used:

```
IF NAN <> io.oneWireSensor1 Then  
  ' send email  
ELSE  
  ' do something else  
END IF
```

Note: In most BASIC interpreters, 'Function 1' (see above) may be placed after the THEN statement. This interpreter requires 'Function 1' to be put on the following line.

FOR TO, NEXT

The FOR TO statement loops a section of code a predefined number of times. The NEXT statement always follows the section of code to be looped. The format is:

```
FOR (variable) = (expression) TO (expression)  
  (code to be looped)  
NEXT (variable)
```

DO WHILE, LOOP

The DO WHILE statement loops a section of code while a condition is found true. The LOOP statement always follows the section of code to be looped. Note that if the condition is omitted, the code will be looped without end. The format is:

```
DO WHILE (variable) (=, <, >, <=, >=, <>) (expression)  
  (code to be looped)  
LOOP
```

If the loop is to continue indefinitely, the format would be:

```
DO  
  (code to be looped)  
LOOP
```

Example:

```
let t0 = 100
do while t0 > 0
  ' wait
loop
```

LOG

The LOG statement causes the device to log data according to the settings specified under the *Logging setup tab*.

Note: In order to log, logging must be enabled in the Logging setup tab.

The format is: LOG

EMAIL

The EMAIL statement causes the device to send an email of the same format as that generated by other status change and alarm conditions. If an I/O variable is given as a parameter, then the subject line in the email will contain "Variable Name = Variable Value". If no I/O variable is given, then the subject of the email will be "Basic Script".

EMAIL (io.relay1, etc)

Examples:

```
EMAIL
...or...
EMAIL io.relay2
...or...
EMAIL io.input1
...or...
EMAIL io.temp2
```

END

The END statement ends the main body of code.

CALL

The CALL statement is found within the main body of code, but requires the interpreter to skip to a subroutine found at the end of the program. After the subroutine is finished, the interpreter returns to the line immediately following the CALL statement. The format is:

CALL (name of subroutine)

SUB, END SUB

The SUB statement defines the beginning and name of a subroutine. The END SUB statement defines the end of the respective subroutine. Subroutine names can be up to 20 characters long and are case sensitive. The SUB and END SUB statements always must follow the END statement. The format is:

END

**** Subroutines Go Here ****

SUB (name of subroutine)

(contents of subroutine)

END SUB

SUB (name of subroutine)

(contents of subroutine)
END SUB

REM or '

The REM or apostrophe (') statement designates remarks made by the programmer. The interpreter will disregard any characters on the line following these statements.

6.8.4 User-Defined Variables

Two types of variables are available for use in the ControlByWeb™ BASIC interpreter, user-defined variables, and predefined variables.

Up to 10 user variables may be initialized. These must be single character, lower case letters.

a, b, c, d, e, f, g, h, i, j

They are always global and stored internally as floating point numbers. Variables are defined using the LET statement.

Examples:

```
Let b = 5           'variable b will be set to 5
Let d = b + 2      'variable d will be set to 7
```

6.8.5 Predefined Variables

The following are useful predefined variables for the ControlByWeb™ BASIC interpreter. These are useful for accessing internal values and features states.

Timer Variables

Ten timers are available for use in BASIC scripts.

t0, t1, t2, t3, t4, t5, t6, t7, t8, t9

Timers can be set to any positive integer (or 0) by using the LET statement. As soon as a value is assigned to a timer, it will begin to count down immediately by decrementing one count every 100 ms until it reaches zero.

Examples:

```
Let t3 = 1500      'set timer 3 to 150 seconds
Let t1 = 0         'disable time 1
```

These timers are different than the Timer I/O that can be configured under the I/O setup tab. They are only accessible to the BASIC script, and their resolution is 100 ms. The Timer I/O can also be accessed from the basic script as io.timer1, etc. These timers have 1 second resolution.

Date and Time Variables

The variables 'time' and 'date' are predefined, read only variables that store the current date and time. They can be used to schedule events and activities, such as sending emails, reading temperature, or setting outputs. The date uses the mm/dd/yyyy format. Clock time is formatted as hh:mm:ss (24-hour clock).

Example:

```
If date = 01/01/2014 Then
  If time > 12:30:00 Then
    Let io.relay2 = 1
    Let io.relay3 = 0
  End If
End If
```

Note: Current date and time can only be set in the Date/Time tab.

Event Variables

Data and time variables can be used to execute script events.

Up to 10 date variables are available:

```
ed0      'event date variable 0
...      'ed1, ed2, ed3, ed4, ed5, ed6, ed7, ed8,
ed9      'event date variable 9
```

The value assigned to event variables should be in the format mm/dd/yyyy. The event-date variables store the number of days that have passed since January 1, 1970.

Event-time variables may be used in math expressions as well as comparison statements.

Time variables have a similar naming convention.

```
et0      'event time variable 0
...      'et1, et2, et3, et4, et5, et6, et7, et8
et9      'event time variable 9
```

Event-time variables are declared in the format hh:mm:ss in 24-hour time. The event-time variables store the number of seconds from the beginning of the day.

Event-date and event-time variables of the same number are linked. If the event-time variable is incremented more than the number of seconds in a day (86400 seconds), the variable is reset to 0 and the event-date variable is incremented by one. For example, if et3 rolls over to zero, ed3 will be incremented.

The following script example demonstrates defining the event variables and comparing it to the current date and time. Assume current time is April 10, 2010 at 1:30 AM and the event should occur in one hour and every hour thereafter.

Example:

```
Let a = 1
Let ed1 = 04/10/2010      'sets the event date to April 10,
                          '2010.

Let et1 = 02:30:00      'sets the event time to 2:30
Do While a <> 0
  If ed1 >= date Then    'Tests event date versus current date.
    If et1 >= time Then  'Tests event time versus current time.
      Let et1 = et1 + 3600 'Increments the event time by one hour
                          '(in seconds).
                          'Event to occur would go on this line
    End If
  End If
Loop
End
```

6.8.6 I/O Variables

The BASIC interpreter has full access to all configured I/O on the X-410. The I/O are treated as variables and can be read and written to the same as other variables. With the X-410 the I/O resources are not fixed. After 1-Wire sensors, registers and other I/O are added and defined they can be controlled and monitored within BASIC scripts. BASIC scripts must reference I/O resources such as digital inputs and relays in the form of io.name where "name" is the resource name defined when the resource was added in the I/O Setup Tab. If the resource name has embedded spaces, they must be removed in the io.name statement. For example, if a relay is named "Warehouse Fan", the fan can be turned on with the BASIC statement "LET io.warehouseFan = 1". If a resource name is changed during development and testing, the resource name in the BASIC script must be renamed to match.

The View Basic I/O Tokens button on the BASIC setup page displays a list of all of the I/O resources currently available together with the equivalent token to be used in BASIC scripts to reference the respective I/O resource.

Relay Variables

Relay variables are represent the state of the relays and can be used to change the state of the relays. Remote relays and local relays are read and controlled the same. Below is an example on how to access the relays provided they are at the default names.

```
io.relay1          'relay 1
io.device1Relay1  'remote relay 1
```

Note: Commands can be sent to remote relays, but the states of those relays cannot be reliably read immediately. Consequently, remote relays should not be used in safety or security-critical applications.

Relay outputs can be turned ON, turned OFF, pulsed, toggled, or read in BASIC scripts. The LET statement is used to set the output state. The state options available are:

```
0 – turn relay off
1 – turn relay on
2 – pulse relay
5 – toggle relay
```

The pulse time is specified in the **Relay** setup tab.

Examples:

```
Let io.relay1 = 1  'turn on relay 1
Let io.relay1 = 0  'turn off relay 1
Let io.relay1 = 2  'pulse relay 1
Let io.relay1 = 5  'toggle relay 1
Let a = io.relay2  'read the state of relay 2, state will be 0 or 1
```

Input Variables

The digital input states can be read in BASIC scripts. Below is an example assuming the name for input 1 is left at the default.

```
io.digitalInput1  'digital input 1
```

Example:

```
Let a = io.digitalInput1  'sets 'a' equal to value of input 1
```

Registers

Registers are similar to general purpose variables and can be used in the same manner. The difference between general purpose variables and registers is that registers can be accessed by the user through a web browser and modified while the script is running. Scripts can use registers as a method of retrieving input from the user or through any of the scheduled, conditional or reboot tasks. Below is an example of how to access a register assuming it is at the default name.

```
io.register1
```

The following example demonstrates the BASIC script reacting to user input by creating a script that will turn **ON** a remote relay if *Register 1* equals 1 and turn **OFF** if a remote relay if *Register 1* equals 0.

Example:

```

Do
  If io.register1 = 1 Then
    Let io.device1Relay1 = 1
  Else
    Let io.device1Relay1 = 0
  End If
Loop
End

```

Registers can also be used to show numeric values, such as a count-down timer. The following code will show a count down from 10 seconds and automatically restart. The refresh rate must be configured in the *Control Page* setup in order to see each of the count down values.

Example:

```

let t0 = 10                                'Initialize variables and start timer
let io.register1 = 10

'Main Loop
Do
  if t0 = 0                                'when timer reaches 0 decrement counter
    let io.register1 = io.register1 - 1
    let t0 = 10
  end if

  if io.register1 < 0                       'restart when counter reaches zero
    let io.register1 = 10
  end if

loop
end

```

Counter Variables

The input counter can be read in BASIC scripts. Below is an example assuming the name for input 1 is left at the default.

```

io.digitalInput1.count                    'input 1 counter

```

Example:

```

If io.digitalInput1.count > 5000 Then    'If input counter 1 is greater than
5000 then
  Let io.relay1 = 1                      'turn output 2 on
End If

```

Analog Variables

The analog input scaled values can be read in BASIC scripts. Below is an example assuming the name for analog input 1 is left at the default.

```

io.analogInput1                          'analog input 1

```

Example:

```

If io.analogInput1 > 4 Then              'If Analog Input 1 is greater than 4 then
  Let io.relay1 = 2                      'Pulse output 1, otherwise
Else
  Let io.relay1 = 0                      'output1 will be off
End If

```

Temperature/Humidity Sensor Variables

Each temperature sensor or humidity sensor can be read in BASIC scripts. Below is an example

assuming the name for the 1-Wire sensor is left at the default.

io.oneWire1 'temp or humidity sensor 1

Example:

```
If io.oneWire1 >= 80 Then            'If temperature sensor reads greater than 80
                                     ' degrees, then
    Let io.relay2 = 1                'Turn on relay 2
End If
```

Appendix A: Restoring Factory Default Settings

In the event that the IP address or passwords are forgotten, the X-410 may be restored to its original factory default settings.

1. Remove the DC power from the unit.
2. Use a thin, non-conductive object (such as a toothpick) to press and hold the small button located on the bottom of the unit. When the object is inserted, a tactile feedback can be felt as the button is depressed.

CAUTION: Do not use metal objects for this function

3. While depressing the button, apply power and wait for about 10 seconds before releasing the button. All settings will be back to the original factory defaults. log.txt and syslog.txt are retained.
4. Refer to *Section 2.6: Establishing Communications for Setup* to begin reconfiguration of the X-410.



Appendix B: Installing New Firmware

From time to time, updates are made to the X-410 firmware. Unlike many consumer products, firmware updates are recommended only on an as-needed basis. The firmware can be updated in the field. The procedure for updating the firmware is outlined below. Please note that it is important that this procedure is followed precisely.

Requirements

The firmware update software requires Windows 7/8/10 with the .Net framework installed. The .Net framework is generally installed automatically through Windows update. To install it manually, go to the following address:

<http://www.microsoft.com/downloads/details.aspx?FamilyId=333325FD-AE52-4E35-B531-508D977D32A6&displaylang=en>

Select the Download button. Once you've downloaded the installation file, double-click on the installation file to install the framework.

Setup

1. Contact technical support if a firmware update is needed and a download link will be provided. Only an X-410 image can be installed on the X-410 so make sure the correct image is being downloaded.
2. bootloader.exe will connect to the X-410 using default IP address 192.168.1.2, not the address currently assigned to the X-410. After the update, all settings will be lost and the device will return to its default IP address of 192.168.1.2.

Configure the PC to the same subnet as the IP address 192.168.1.2, such as 192.168.1.10. For instructions on doing this, see *Section Establishing Communications for Setup*.

Note: The IP address of the X-410 will automatically be set to the default 192.168.1.2 during the update process. Since the X-410 supports auto negotiation, a crossover cable is not necessary.

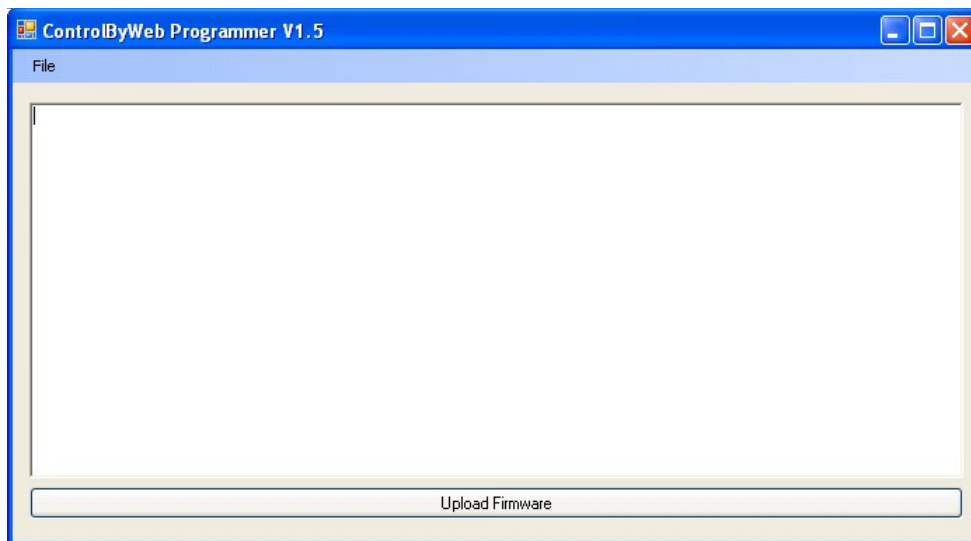

3. Open the bootloader.exe utility on the computer by double clicking on the downloaded file.
4. Within the ControlByWeb™ Programmer utility programmer, select File, then Open. Specify the firmware image downloaded from the ControlByWeb™ web site.

Device Upgrade Procedure

Carefully follow the following steps to put the X-410 into bootloader mode and perform the upgrade:

1. Remove DC power from the X-410.
2. Using a small, non-conductive tool, press and hold the reset button.
3. While holding the reset button, apply power to the X-410. The LINK and ACT lights will flash. Continue to hold the reset button for the next step.
4. While holding the reset button, press the Upload Firmware button at the bottom of the ControlByWeb™ Programmer window. After the programming process begins, the reset button can be released.
5. Programming will take approximately 60 seconds, the LINK LED will stop flashing and remain lit. The X-410 will be set to factory defaults with an IP address of 192.168.1.2.
6. Refer to *Section Establishing Communications for Setup* to reconfigure the X-410. Verify the new version of firmware has been installed by viewing the default setup page with a web browser (<http://192.168.1.2/setup.html>).

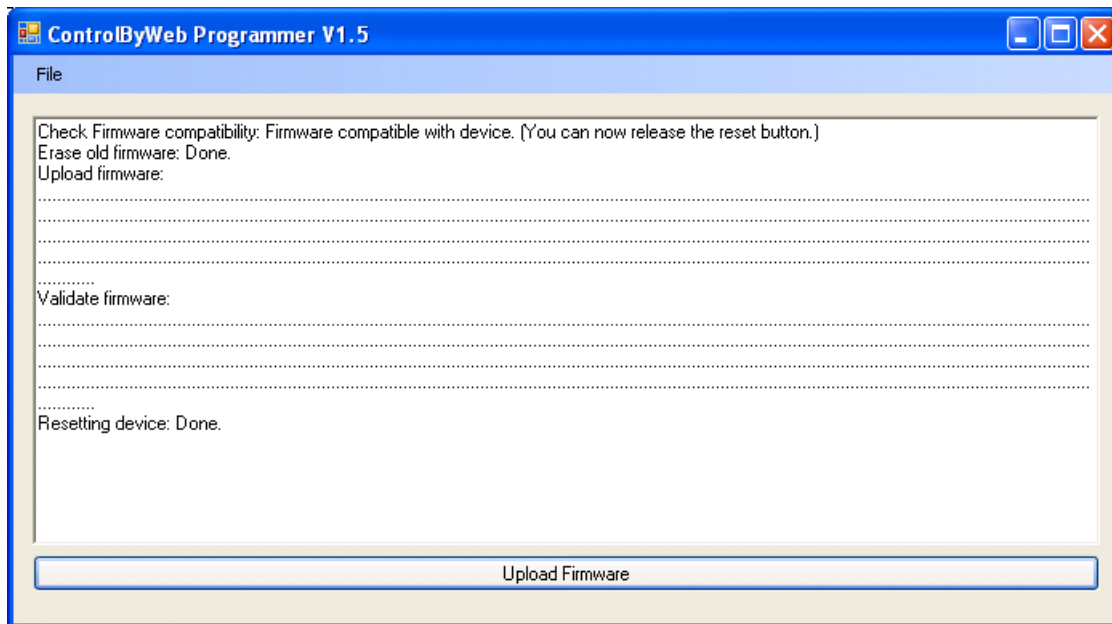

Appendix C: Accessing the X-410 Over the Internet

The X-410 can be monitored and/or controlled from a remote location over the Internet. Once the X-410 can be accessed on the local network, almost all of the settings required to provide remote access are in the router and not in the X-410.

This guide is not meant to be a tutorial in router setup, but rather to provide a basic overview of remote access. For specific details, the user should refer to the instruction manual for the router on the local network. Users not familiar with basic IP networking should study one or more basic IP networking tutorials before proceeding (many tutorials are available on the Internet).

IP Addresses

Every device on the Internet is identified by a unique address called an IP (Internet Protocol) address. IP addresses are somewhat similar to mailing addresses in that they identify the precise logical location of the device on the Internet. The IP address identifies the global region down to the network and then the specific device on that network. IP addresses are globally maintained and assigned by an entity called the Internet Assigned Numbers Authority (IANA). IP addresses consist of four sets of numbers that range from 0 to 255 and are separated by a decimal. For example, 192.168.200.167 is an IP address.

Every device that is “directly” connected to the Internet uses a “public” IP address. The X-410 can be assigned a public IP address for direct connection to the Internet. Typically, a public IP address would only be assigned to the X-410 when it is the only device on the local network. The IP address would be obtained from an Internet Service Provider (ISP).

Due to the limited number of public IP addresses, private networks can be set up with “private” IP addresses. These addresses are used within a local network and have no global designation, they are not routed on the Internet. The following address blocks are designated for private networks (where x represents decimal numbers from 0 to 255): 192.168.x.x, 10.x.x.x, and 172.16.x.x.

A Simple Local Area Network

A small Local Area Network (LAN), can be made up of two or more computers or other devices connected to an Ethernet switch. Each device on the network is assigned a unique private IP address. For example, consider a simple network that consists of a computer, an X-410, and a WebRelay™. In this example, the computer is assigned an IP address of 192.168.1.10, the X-410 has the IP address of 192.168.1.25 and a WebRelay™ has an IP address of 192.168.1.26. A person using the computer can access the X-410 by entering its IP address in the URL line in the browser, <http://192.168.1.25>. Similarly, the WebRelay™ can be accessed by entering its unique private IP address in the URL line in the browser, <http://192.168.1.26>.

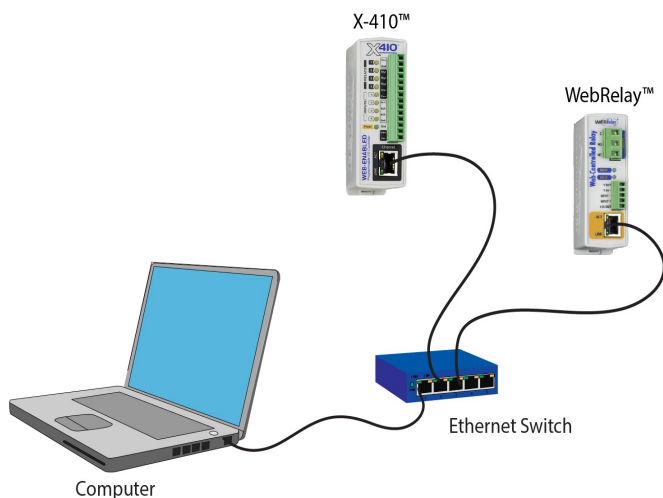

A Simple LAN connected to the Internet

The LAN in the example above can be connected to the Internet by adding a router and an Internet connection. The router has two network connections. It has an Ethernet network connection to the LAN and another connection to the Internet. Often the Internet connection is called a Wide Area Network (WAN) connection. Each network connection on the router has an IP address. In our example, the IP address on the LAN side of the router has an address of 192.168.1.1. The IP address on the WAN side of the router has an IP address that has been assigned by the Internet Service Provider, such as 203.0.113.254.

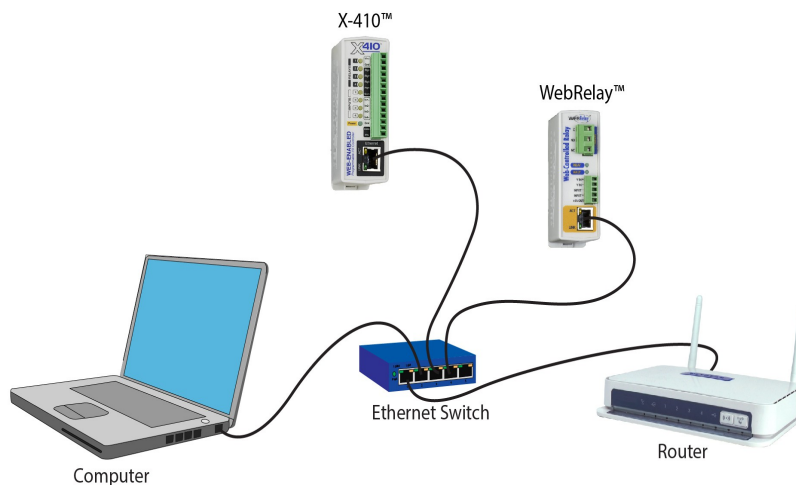

In the example, when a user on the computer needs to access a server on the Internet, the computer sends the request to the router at 192.168.1.1. The router sends the request to the ISP server on the Internet. The ISP server does not send the response directly to the computer on the LAN, but to the router at the IP address of 203.0.113.254. The router then forwards the response to the computer. This way, all devices on the LAN share a single public IP address. This is called Network Address Translation (NAT).

Port Forwarding

The router can be configured to allow outside access to the X-410 and WebRelay™. All requests from the Internet to any device on the local network must use the public IP address (203.0.113.254). With only a single IP address, TCP ports are used to identify the intended device for the incoming message.

Using the mailing address analogy, the port is similar to a post office box. The IP address specifies the location, and the port specifies the specific recipient. Port numbers can be set to any number between 1 and 65535. However, many port numbers are reserved for specific applications and should be avoided. As a general rule, numbers above 8000 are safe to use. All of the ControlByWeb™ products come from the factory with the HTTP port set to 80, which is the standard port for HTTP. In this example, the X-410 HTTP port will be changed to port 8000 and WebRelay™ port will be changed to 8001. Once the ports are changed in the two ControlByWeb™ devices, the router must be set up for port forwarding.

Port forwarding associates the IP address of each local device with an assigned port. In this example, the address 192.168.1.25 for the X-410 would be associated with port 8000. The address 192.168.1.26 for WebRelay™ would be associated with port 8001. The X-410 would be accessed from the Internet by entering the public IP address of the router, plus the port number assigned to the X-410 in the URL window of the browser, `http://203.0.113.254:8000`. All Internet requests to the router for port 8000 would be forwarded to the X-410. Similarly, all request for port 8001 would be forwarded to WebRelay.

Note: When an HTTP request comes in to the router without the specific port specified (`http://203.0.113.254`), the router will handle this as a port 80 request (default HTTP port). In other words, `http://203.0.113.254` is exactly the same as `http://203.0.113.254:80`.

Router configuration can vary widely. Some routers have the capability of translating the addresses and the ports, which would require no port configuration change on the WebRelay. For example, the router would be configured so that messages sent to `http://203.0.113.254:8000` would be forwarded to `http://203.0.113.254:80`, which is the default HTTP port.

An example screen shot of a router configuration is given below. This setup allows the two ControlByWeb™ products in the above example to be accessed remotely from the Internet.

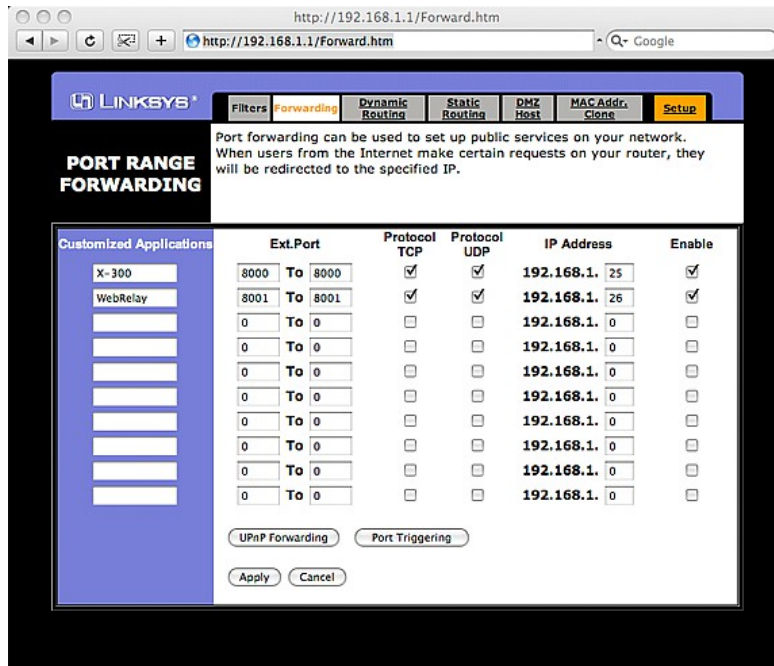

Example of Port Range Forwarding

Note: This screen shot is simply an example of a typical router setup page. Routers will vary.

Accessing Setup Pages

After changing ports, the setup pages are accessed on a local network as described below:

```
http://(Local IP Address):(Port Number)/setup.html
```

For example, to access the setup pages when the port is set to 8000, the following command would be used:

```
http://192.168.1.25:8000/setup.html
```

To access the ControlByWeb™ units from the Internet, enter the public IP address of the router plus the port number of the desired device in the following format:

```
http://(Public IP Address of Router):(Port Number of Device)/setup.html
```

Using the example above, the following line would be used to access the setup page of the X-410:

```
http://203.0.113.254:8000/setup.html
```

Appendix D: Specifications

Power Requirements

Input Voltage:

| | |
|-----------------------|--|
| Model X-410-I: | 9-28 VDC |
| Model X-410-E: | Power Over Ethernet and/or 9-28VDC. 48V injected into Ethernet Line as per 802.3af specification. POE Class 1 (0.44Watt to 3.84Watt range) |

Current: See table below for typical values at 25°C.

| Power Supply | No Relays On No Inputs On | 4 Relays On 4 Inputs On |
|--------------|------------------------------|----------------------------|
| 9 VDC | 110 mA | 240 mA |
| 12 VDC | 85 mA | 180 mA |
| 24 VDC | 50 mA | 100 mA |

I/O Connector

14-position, removable terminal strip, 3.81 mm spacing
(replacement part number, Phoenix Contact 1803691)

Relay Contacts:

| | |
|---|---|
| Number of relays: | 4 |
| Contact Form: | SPST (form A) |
| Contact Material: | AgNi |
| Contact Resistance: | milli-ohm max |
| Internal Relay Mechanical Endurance: | 5,000,000 operations min. (under no load) |
| Internal Relay Electrical Endurance: | 100,000 operations average (under rated load) |
| Max Voltage: | 28VAC, 24VDC |
| Max Current: | 1A |
| Control Options: | On/Off or Pulsed |
| Pulse Timer Duration: | 100ms to 86400 Seconds (1-day) |

Digital Inputs:

| | |
|--|-------------------------|
| Number of Inputs: | 4 |
| Minimum Pulse Time (high or low): | 2.5mS |
| Input Current (lin): | 950uA @ 4V, 8.5mA @ 26V |
| Reverse Voltage (Vr): | 6V max |
| Vin: | 26V (max) |

| | |
|-------------------------------------|------------|
| Vin Hi: | 4V (min) |
| Vin Lo: | 1.5V (max) |
| Input Counter: | 24-bit |
| Max Counter Frequency Input: | 200Hz |

1-Wire Sensor Input

| | |
|-----------------------------------|---|
| +5Vout Output: | 5.0V, 100mA max |
| Maximum Number of Sensors: | 16 |
| Maximum Cable Length: | 600 feet (180m) maximum combined cable length |

Compatible with Maxim (Dallas) Semiconductor DS18B20 digital 1-Wire thermometer.
Compatible with X-DTHS-P (temperature/humidity), X-TC1W-K (thermocouple) and other supported digital 1-Wire sensors.

Sensors are interchangeable, no calibration needed.

Network

10 Base-T or 100 Base-T Ethernet IPv4 (10 Mbit/s or 100 Mbit/s)
Static IP address assignment or DHCP
HTTP port selectable
HTTPS port selectable
Standard 8-pin RJ-45 modular socket, with auto-negotiation
Supports Encrypted Web Browser (HTTP/HTTPS), Modbus/TCP, SNMP V1,2C,V3 protocols

LED Indicators (11)

| | |
|--------------------------|--------|
| Power: | Green |
| Relay (1-4): | Yellow |
| Input (1-4): | Yellow |
| Network Linked: | Green |
| Network Activity: | Yellow |

Email Alerts

| | |
|--------------------------------|--|
| Email Addresses: | Configurable, up to 8 addresses |
| Encrypted Email Alerts: | STARTTLS and TLSL/SSL |
| Status Alerts: | Inputs, temperatures, 1-Wire sensors, relays, etc. |
| Other Alerts: | Alert logic is fully customizable |

Real-Time Clock

Manual or NTP (Network Time Protocol) setup
NTP Sync configurable for once, daily, weekly, or on power-up
Automatic daylight savings adjustment
Battery (capacitor) backup: 2-weeks min, supports real-time clock, 1 register and local relay states

Nonvolatile Memory

Flash Memory

All user settings are stored in nonvolatile memory. Settings will not be lost when power is disconnected.

Logging

Stored in Nonvolatile Flash

Circular Buffer

512-Kbyte (up to 8448 log entries depending on configuration)

Unlimited data storage possible through sending the log through email or FTP services.

Password Settings

Password protection for *Administrators* (setup pages)

Optional password protection for *Managers*

Optional password protection for *Users* (control page)

Base 64 Password Encoding

Password Length: 18 character, case sensitive

Scripts

Implement special or custom features with a BASIC script

Max size: 4-Kbytes

Environmental

| | |
|-------------------------------|----------------------------------|
| Operating Temperature: | -40°C to 65.5°C (-40°F to 150°F) |
| Storage Temperature: | -40°C to 85°C (-40°F to 185°F) |
| Altitude: | up to 2000m |
| Humidity: | 5-95% non-condensing |

Mechanical

| | |
|----------------|--|
| Size: | 1.41 x 3.88 x 3.1 in. (35.7 x 98.5 x 78 mm), not including connector |
| Weight: | 5 oz (142 g) |

Electromagnetic Compliance

IEC CISPR 22, CISPR 24

EU EN55024, EN55022

X-410-I: FCC 47CFR15 (Class B)

X-410-E: FCC 47CFR15 (Class A)

Product Safety Compliance

UL 61010-1 (Electrical Equipment for Measurement, Control, and Laboratory Use)

Appendix E: Trademark and Copyright Information

This document is Copyright ©2017-2018 by Xytronix Research & Design, Inc. All rights reserved.

X-410™, WebRelay™, ControlByWeb™, and Xytronix Research & Design™ are trademarks of Xytronix Research & Design™, Inc. 2005-2018.

All other trademarks are the property of their respective owners.

All parts of this product and design including but not limited to firmware, hardware design, schematics, PCB layout, concept, graphics, users manual, etc., are property of Xytronix Research & Design, Inc. ©2005-2018. X-410™ may not be copied or reverse-engineered.

No part of this manual may be reproduced or transmitted in any form or by any means, electronic or mechanical, including photocopying or scanning, for any purpose other than the personal use by the purchaser of this product. Xytronix Research & Design, Inc., assumes no responsibility for any errors that may appear in this document.

Whereas reasonable effort has been made to make the information in this document as useful and accurate as possible, Xytronix Research & Design, Inc. assumes no responsibility for the application, usefulness, or completeness of the information contained herein. Under no circumstance will Xytronix Research & Design, Inc. be responsible or liable for any damages or losses including direct, indirect, special, incidental, or consequential damages or losses arising from either the use of any information contained within this manual or the use of any products or services referenced in this manual.

Xytronix Research & Design, Inc. reserves the right to change any product's features, specifications, documentation, warranties, fee schedules, and conditions at any time and without notice.

Appendix F: Warranty

This Xytronix Research & Design, Inc. product is warrantied against defects in material and workmanship for a period of five years from the date of shipment. During the warranty period, Xytronix Research & Design, Inc. will, at its option, either repair or replace products that prove to be defective. This warranty is extended to the original purchaser of the equipment only.

For warranty service or repair, customer must contact Xytronix Research & Design, Inc. technical support (support@ControlByWeb.com) and obtain a Return Authorization number (RA#). Before issuing an RA#, a support technician will work with customer to try to resolve the issue without returning the product. If technician determines that product must be returned for service an RA# will be issued. Next, the product must be properly packaged and returned to Xytronix Research & Design, Inc. with the RA# clearly marked on the package. The purchaser shall prepay all charges for shipping to Xytronix Research & Design, Inc. For warranty repairs of products less than one year old, Xytronix Research & Design, Inc. will pay the shipping charges to return the product to the purchaser as long as the product is shipped within the continental United States. If the product is shipped outside of the continental United States or the product was shipped more than one year earlier, the purchaser shall pay all shipping charges both ways.

Limitation

The foregoing warranty shall not apply to defects or damage resulting from improper use or misuse, unauthorized repair, tampering, modification, improper connection, or operation outside the electrical/environmental specifications for the product. Further, the warranty does not cover damage from Acts of God, such as lightning, fire, flood, hurricanes and tornadoes. This warranty does not cover damage to property, equipment, direct, indirect, consequential, or incidental damage (including damage for loss of business profit, business interruption, loss of data, and the like) arising out of the use or misuse of this product.

UNDER NO CIRCUMSTANCES WILL THE LIABILITY OF XYTRONIX RESEARCH & DESIGN, INC. TO THE PURCHASER OR ANY OTHER PARTY EXCEED THE ORIGINAL PURCHASE PRICE OF THE PRODUCT, REGARDLESS OF THE FORM OF THE CLAIM. No other warranty is expressed or implied. Xytronix Research & Design, Inc. specifically disclaims the implied warranties or merchantability and fitness for a particular purpose. Some jurisdictions may not allow the exclusion of limitation of liability for consequential or incidental damage.

Appendix G: FCC Statement

This device complies with Part 15 of the FCC Rules. Operation is subject to the following two conditions:

1. This device may not cause harmful interference.
2. This device must accept any interference received, including interference that may cause undesired operation.

Warning

This equipment has been tested and found to comply with the limits for a Class B digital device, pursuant to part 15 of the FCC Rules. These limits are designed to provide reasonable protection against harmful interference in a residential installation. This equipment generates, uses and can radiate radio frequency energy and, if not in-stalled and used in accordance with the instructions, may cause harmful interference to radio communications. However, there is no guarantee that interference will not occur in a particular installation. If this equipment does cause harmful interference to radio or television reception, which can be determined by turning the equipment off and on, the user is encouraged to try to correct the interference by one or more of the following measures:

- Reorient or relocate the receiving antenna.
- Increase the separation between the equipment and receiver.
- Connect the equipment into a relay on a circuit different from where the receiver is connected.
- Consult the dealer or an experienced radio/TV technician for help.

Notice

Changes or modification not expressly approved by the party responsible for compliance could void the user's authority to operate the equipment.

Appendix H: Licensing

The webpages on the X-410 use javascript libraries that contain permissive free software licenses such as MIT and BSD 3-Clause. The licenses and copyrights are included directly in the source for setup.html on the X-410.

The firmware included in this product also contains copyrighted software that is licensed under various permissive free software licenses.

mbedtls - Copyright (C) 2006-2015, ARM Limited, All Rights Reserved
License: Apache-2.0
<http://www.apache.org/licenses/LICENSE-2.0>

lwIP - Copyright (c) 2001-2004 Swedish Institute of Computer Science.
All rights reserved.

Redistribution and use in source and binary forms, with or without modification, are permitted provided that the following conditions are met:

1. Re-distributions of source code must retain the above copyright notice, this list of conditions and the following disclaimer.
2. Re-distributions in binary form must reproduce the above copyright notice, this list of conditions and the following disclaimer in the documentation and/or other materials provided with the distribution.
3. The name of the author may not be used to endorse or promote products derived from this software without specific prior written permission.

THIS SOFTWARE IS PROVIDED BY THE AUTHOR "AS IS" AND ANY EXPRESS OR IMPLIED WARRANTIES, INCLUDING, BUT NOT LIMITED TO, THE IMPLIED WARRANTIES OF MERCHANTABILITY AND FITNESS FOR A PARTICULAR PURPOSE ARE DISCLAIMED. IN NO EVENT SHALL THE AUTHOR BE LIABLE FOR ANY DIRECT, INDIRECT, INCIDENTAL, SPECIAL, EXEMPLARY, OR CONSEQUENTIAL DAMAGES (INCLUDING, BUT NOT LIMITED TO, PROCUREMENT OF SUBSTITUTE GOODS OR SERVICES; LOSS OF USE, DATA, OR PROFITS; OR BUSINESS INTERRUPTION) HOWEVER CAUSED AND ON ANY THEORY OF LIABILITY, WHETHER IN CONTRACT, STRICT LIABILITY, OR TORT (INCLUDING NEGLIGENCE OR OTHERWISE) ARISING IN ANY WAY OUT OF THE USE OF THIS SOFTWARE, EVEN IF ADVISED OF THE POSSIBILITY OF SUCH DAMAGE.

Appendix I: Mechanical Dimensions

A 3D-CAD model of the X-410 is also available at https://www.controlbyweb.com/x410/x-410_3d.stp

